

CAMBRO®

2016|17

product catalog

www.cambro.com



CAMBRO® CATALOG TABLE OF CONTENTS

equipment



FOOD HOLDING & TRANSPORTATION

Cam GoBox	8
Insulated Beverage Containers	12
Beverage Service Cart	15
Insulated Food Servers (Non-Electric)	16
Camchiller®, Thermobarrier® & Camwarmer®	18
Temperature Maintenance	19
Transporter Capacity Guide	24
Insulated Food Servers (Electric)	25
Tablotherm	36



WAREWASHING, HANDLING & STORAGE

6	58
Camrack® 4-in-1 System	59
Personalization	70
Camdollies®	72
Tray & Dish/Silver Cart	75
S-Series Adjustable Dish Caddy	76
Dish Caddies	77
Cambox® Bus Boxes	80
KD Service Cart & KD Utility Cart	81
Service Carts	82
Sizing & Reference Guide	265



CAMSHELVING® ELEMENTS SERIES

110

Camshelving Elements Series	110
Weight Bearing Chart	111
Elements Series Configurations	112
Elements Series Accessories	117



MOBILE VENDING

37	38
Versa Food Service System	38
Food Bar Accessories	41
Table Top Food Bars	42
Sample Food Bar Set-ups	43
CamKiosk® System	44
Hand Sink Cart	46
Camcruiser® Vending Carts	47
Booster Seats	49
Versa Organizers	49
Portable CamBars®	51
Ice Caddies	57



CAMSHELVING® PREMIUM SERIES

83	86
Common and Key Features	86
Quick Reference Guide	88
Product Code Reference Guide	90
Free Camshelving Design Service	91
Overall Length — Quick Reference Guide	92
Camshelving Premium Series	94
Weight Bearing Chart	95
Premium Series Configurations	96
Premium Series Accessories	101
High Density Storage	
Floor Track System	106



CAMSHELVING® BASICS SERIES

122

122	122
Camshelving Basics Series	122
Weight Bearing Chart	123
Basics Series Configurations	124
Basics Series Accessories	127
Wall Shelves and Shelf Extenders	130
Dunnage Racks	131
Camlink®	131

supplies



FOOD STORAGE AND PREPARATION 133

Quick Guide To Storage Solutions	134
Food Storage Containers	136
Food Storage Boxes & Lids	144
Camwear® Food Pans & Lids	148
H-Pans™	152
Translucent Food Pans	156
ColdFest®	158
StoreSafe® Labels	159
Pizza Dough Boxes	160
Ingredient Bins & Camcrisper	161
Scoops & Measuring Cups	162



FOOD PRESENTATION 178

Deli Crocks & Platters	179
ShowFest® Display Bowls & Trays	180
Serving Bowls	181
Display Covers & Trays	184
Crocks & Ladles	185
Serving Spoons, Camtensils® & Turners	186
Tongs	187
Shakers/Dredges & Condiment Jars	188

healthcare



HEALTHCARE 234

Meal Delivery Ware	238
Reusable CamLids® for Meal Delivery Systems	240
Camrack® Wash and Store Rack	240
Disposable CamLids	241
Camshelving®	242
Hygienic Drying Racks	244
Tablotherm	244
Versa Trays	246
Non-Slip Versa Trays	248
Camtrays® with Handles & Polycarbonate Non-Slip Tray	250
Meal Delivery Carts	251

GENERAL INFORMATION

Icon Directory	5
Warranty	5
Alpha Numeric Listing	255
Roto Color Chart	267

PERSONALIZATION

CamKiosk®	45
Camcruisers®	48
Camracks®	70
Table Service/Storage Trays	167
	197

www.cambro.com

Visit www.cambro.com for a wide variety of information about our products including new product updates, an interactive Camrack Glass to Rack Guide, consultant cut sheets and CAD drawings, care and maintenance product guides and more.



TABLE SERVICE 163

Dinnerware	164
Camcovers®	166
Personalization	167
Pitchers	168
Aliso® Barware	169
Cambro® Tumblers & Disposable CamLids®	170
Camliter®	175
Beverage Dispenser, Pail With Bail & Swirl Bowls®	176
Wine Buckets, Punch Bowls & Bud Vase	177



TRAYS 191

Tray Product Guide	194
Personalization	197
Polyester Versa Trays	199
Versa Lite Trays	206
Camtrays®	211
Dietary & Camlite® Trays	217
Polycarbonate Trays	218
Camtread® Trays	219
Treadlite™ & Polytread Trays®	220
Wood Trays	221
Corfu, Capri, Mykonos, & Madeira Trays	223
Fast Food Trays	228
Compartment Trays	229
Market Trays & Pans	233

The Trademarks of Cambro and product images are the property of Cambro and are subject to the control and ownership of Cambro. Any use thereof is only granted for the promotion and sales of Cambro products and subject to the control of Cambro Manufacturing Company.

The Cambro® Story

When William and Argyle Campbell first opened the doors at Cambro Manufacturing in 1951 their goal was to make a hospital meal tray of the highest quality possible. Named the Camtray®, it demonstrated that they were as committed to excellence in the food service industry as they were to the quality of their own products. As 2011 marks the company's 60th year of leadership in quality, innovation and customer service, today Cambro serves the world with the industry's most complete selection of products for widely diverse segments of the food service business.

Since 1951, the company has experienced many changes including a greatly expanded product line, new methods of manufacturing and distribution, and an increased emphasis on issues like environmental responsibility. From a single factory in California, Cambro has grown to become an international presence with production facilities and sales offices in the United States, Europe, the Middle East and Asia. But the original guiding vision of the Campbell brothers remains unchanged: to create and provide the most innovative, durable and highest quality products for the food service industry. Now led by William's son Argyle, Cambro is still dedicated to meeting our customers' needs, and equally committed to helping you serve, satisfy and delight your guests.

At the heart of our business philosophy is our willingness to listen, so in a very real way we owe all our success to you, our customer. Our longevity in a very competitive field for 60 years certainly proves the value of that philosophy, and we are proud to have earned the loyalty of customers of all sizes and in all segments of the industry. From hotels to healthcare to caterers, from restaurant chains to educational facilities, we understand the food service business and we design and create our products with the end user foremost in mind. Our goal is to provide our customers the best

possible value on products that are durable, save labor and increase food safety, so you can offer your guests a superior experience while enhancing profitability.

Cambro is uniquely committed to investing in the people and processes that make our products a reality. We're proud that children and grandchildren of some of our first employees are with us today, and of the dedication to quality and service of our entire family worldwide. We continually work on developing new ideas for specific industry segments, and invest in new tooling and leading-edge machinery to bring these products to market. We persistently strive to improve our manufacturing methods to be more efficient in terms of process and materials, to keep costs under control while keeping our planet healthy. And we constantly seek to maintain quality and value despite rising costs of transport and raw materials, the need to reduce environmental impacts, and the demand of end users for total order accuracy and responsive service across a global market.

From once offering a single product, the Camtray, sixty years ago, today Cambro offers a wide range of trays, table service and display items, storage, shelving, merchandising and insulated transport products, as well as innovative warewashing systems and healthcare meal delivery solutions.

The future is certain to bring great changes to our industry. Yet one thing that will remain a constant is Cambro's tradition of continually developing new products that help food service operators save time and money, increase sales, reduce labor and improve service. In the years ahead, guided by the commitment of its founders to innovation, quality, and value, Cambro Manufacturing will still be the leader in serving the food service industry and you, our valued customer.



CAMBRO WARRANTY

- 5 year pro-rated warranty against damage or defects found in excess to normal wear and tear on
 - Camtrays®
 - Camtread Trays®
- 5 year warranty against breakage in excess to normal wear and tear
 - Versa Trays
 - Dinnerware
- 2 year warranty against breakage under normal use
 - Polycarbonate food storage pans
 - Polycarbonate Squares
 - Polycarbonate Rounds
 - Polycarbonate Lids
- 1 year warranty on
 - Commercial Electric Equipment models
- 1 year warranty on workmanship and Lifetime Limited warranty against rust and corrosion, excluding mobile posts.
 - Camshelving®
 - Camshelving Elements Series
- For all other Cambro products, Cambro warrants to the original buyer a three-year pro-rated warranty. If product proves defective during this time, Cambro grants a pro-rated credit of the original price toward replacement product. The warranty applies on all Cambro products only when used under normal foodservice industry conditions.

Specifications, features and equipment shown are based upon the latest information available. Cambro Manufacturing Company reserves the right to make changes at any time, without notice, to price, colors, specifications, accessories and materials. For additional information, please contact your authorized Cambro representative.

Note: Temperature ranges noted throughout this catalog are based on specific test criteria and provide a general guideline. Individual use may vary due to differences in loading temperatures or ambient temperature.

Product Accessories: Contents and accessories shown in photos are not included, except where noted.

ICON DIRECTORY

Throughout the Cambro catalog, find the following easy to identify icons to help explain Cambro product features or services.



Food Safety Matters

For 60+ years, Cambro foodservice equipment and supplies have earned the trust and loyalty of customers and public health professionals alike because our products are designed with Food Safety in mind. At Cambro, every product design is based upon the core principle of food safety.

Look for the Cambro StoreSafe mark throughout the Cambro catalog to identify Cambro storage and transportation products that help ensure food safety handling.

You can learn more about Cambro's Food Safety initiatives at www.cambro.com/storesafe



Many Cambro products may be recycled. For further information, please contact your Cambro representative.



Listed by NSF International, an independent, not-for-profit organization which certifies products that meet their criteria for sanitation and cleanability.



Foam Insulation



Cambro "Storage Select" BPA-Free (Bisphenol-A Free) products are available for customers who are interested in products deemed BPA-Free.

Please contact your sales representative for more information.



Not For Use In Heated Carts



Prorated Warranty



Fit for Food Products



Personalization Available
Non-Food Contact Areas Only



Certifies products by Technischer Überwachungs-Verein. (Technical Inspection Association)



Dishwasher Safe



One carton of product is within the weight and cube requirements to be shipped by parcel carrier.



New Product



Stackable



CAMBRO

Equipment

FOOD HOLDING &
TRANSPORTATION

MOBILE VENDING
EQUIPMENT

WAREWASHING,
HANDLING & STORAGE

CAMSHELVING®



FOOD HOLDING AND TRANSPORTATION

Cam GoBox® – Insulated Carrier Line

Insulated Beverage Containers

Beverage Service Carts

Insulated Top Loading Camcarriers®

Temperature Maintenance Tools

Insulated Front Loading 300MPC & UPC400

UPCS400 Ultra Pan Carrier® S-Series

Ultra Camcarts®

Transporter Capacity Guide

Ultra Pan Carrier® and Ultra Camcart® H-Series

Combo Cart™ Plus

Camtherm® Electric Food Holding Cabinets

Insulated Bakery Container

Camcarts®

Camcarriers®

Tablotherm Insulated Trays



CAM GOBOX® – INSULATED CARRIER LINE

Cambro's latest line of insulated transporters are ideal for caterers and foodservice operators looking for an ultra-lightweight transporter that offers superior temperature retention to protect food safety and excellent durability to withstand heavy commercial use, all at a budget-friendly price. Just take them and go!

- Thermal Insulation – Holds hot or cold food for many hours.
- Lightweight – Made of EPP (Expanded Polypropylene) – an eco-friendly, high-performance foam material.
- Great Structural Strength – capable of handling significant loads while maintaining its shape and form.
- Excellent Energy Absorption – can withstand substantial impact without damage.
- Chemically Inert – unaffected by oil, grease, and most chemicals.
- Dishwasher safe.
- CFC-Free.
- 100% Recyclable.
- Line your Cam GoBox with a Cambro GN Food Pan and Seal Cover for the ultimate food safety solution. Cambro GN pans protect food and carrier to support HACCP compliance.

Only available from Cambro European Logistics (CEL), Germany.

CAM GOBOX® – INSULATED CARRIER LINE



Hot Holding

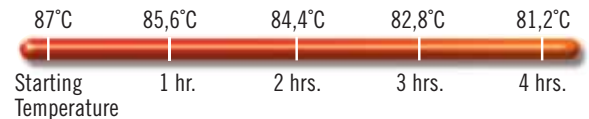

Cold Holding

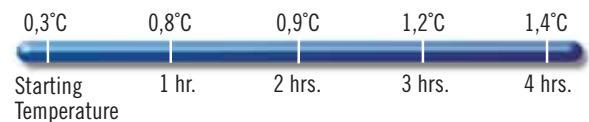

Using Cam GoBox carriers together with Cambro's polycarbonate, polypropylene or high heat GN food pans creates the ideal food-safe, HACCP-compliant holding and transport system.



Ergonomic Handles

Comfortable handles allow easy and safe lifting of the Cam GoBox.



Stackability

Cam GoBoxes inter-stack and also stack with major competitive brands.



Easy Identification

A built-in label area keeps plastic menu tags (included for EPP300 and EPP400) in place for easy content identification or routing. StoreSafe Labels can also be used with Cam GoBoxes.



Easy Loading and Unloading

Interior wall recesses make loading and unloading easy for both GN 1/1 as well as 1/2 pans.



4-Sided Handling

Thoughtfully designed built-in handles along the top of the front loader units allow them to be easily carried from all four sides.

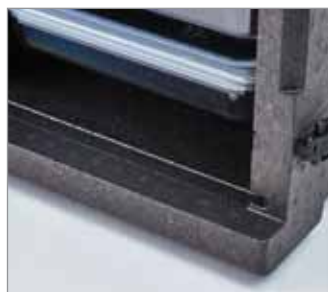

Drip-Resistant

Built-in condensation barrier helps front loaders to remain drip-resistant.



Gentle Open and Close

Beveled door edges ensure door can be easily closed and latched.



Full 270° Access

Durable hinges and latches allow the door to open 270° and remain open securely to the side of the front loader for easy access to products. Latches keep door securely closed during transport.

CAM GOBOX® – INSULATED CARRIER LINE

Exclusive inter stacking design saves **30%** storage space!



CODE	EPP160	EPP180	EPP180S
DESCRIPTION	EPP top loader for 15 cm GN pan	EPP top loader for 20 cm GN pan	EPP stacking top loader for 20 cm GN pan
EXTERIOR DIM. L x W x H	60 x 40 x 25,7 cm	60 x 40 x 31,6 cm	60 x 40 x 18,2 cm (top) 58,6 x 33,6 x 10 cm (bottom)
INTERIOR DIM. L x W x H	53,8 x 33,8 x 19,3 cm	53,8 x 33,8 x 25,3 cm	53,8 x 33,8 x 15,9 cm (top) 50,4 x 30,2 x 9,5 cm (bottom)
UNIT WEIGHT	1,07 kg	1,2 kg	1,13 kg
VOLUME	35,5 L	46 L	43 L

Case Pack: 1 Color: Black (110).



CODE	EPP180PKG	EPP180SPKG
PACKAGE INCLUDES	EPP180 top loader 18PP (20 cm polypropylene GN pan) 10PPCWSC (Seal Cover)	EPP180S top loader 18PP (20 cm polypropylene GN pan) 10PPCWSC (Seal Cover)
UNIT WEIGHT	2,8 kg	2,7 kg
VOLUME	46 L	43 L

Case Pack: 1 Color: Black (110).



CODE	EPP300	EPP400
DESCRIPTION	Front loader	Front loader
EXTERIOR DIM. L x W x H	64,5 x 44 x 47,5 cm	64,5 x 44 x 63 cm
INTERIOR DIM. L x W x H	53,5 x 33 x 37 cm	53,5 x 33 x 52,5 cm
UNIT WEIGHT	3,2 kg	3,9 kg
VOLUME	60 L	86 L

Case Pack: 1 Color: Black (110).



Optional Accessories



CODE	CP3253*	HP3253*	EPP3253DIV	CD3253EPP	EPPID5
DESCRIPTION	Camchiller® GN 1/1 fits all Cam GoBoxes	Camwarmer® GN 1/1 fits all Cam GoBoxes	ThermoBarrier® fits EPP300 & EPP400	Camdolly® fits all Cam GoBoxes	Plastic ID labels fits all Cam GoBoxes
EXTERIOR DIM. L x W x H	53 x 32,5 x 3 cm	53 x 32,5 x 3 cm	—	—	—
UNIT WEIGHT	3,9 kg	3,25 kg	0,37 kg	4,5 kg	—
COLOR	Cold Blue (159)	Hot Red (158)	Black (110)	Hot Red (158)	(000)

Case Pack: 1 * Suitable for all front loader of UPC Series.

CAM GOBOX® CAPACITY GUIDE

All Cam GoBox carriers are designed with enough room to hold GN 1/1 pans along with Camwarmers® or Camchillers®, if desired.

Top Loaders

EPP160

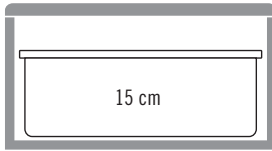

19,5 L

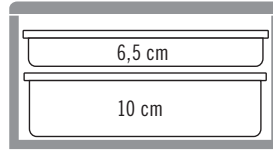

21,5 L

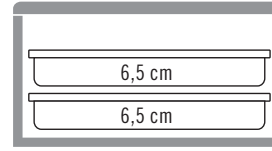

17 L

EPP180

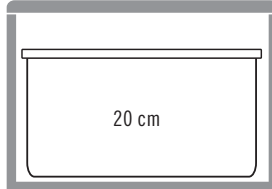

25,5 L

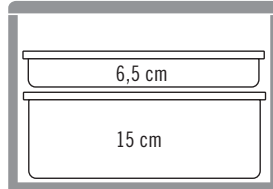

28 L

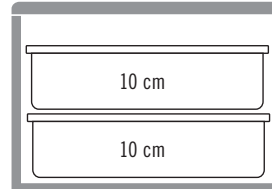

26 L

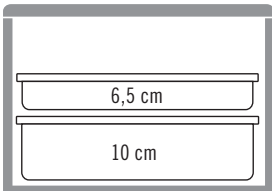

21,5 L

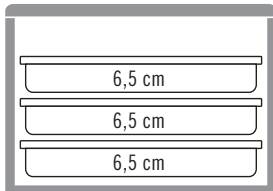

25,5 L



Note: Best results will be achieved by loading food pans between 82° to 88°C. Loading metal food pans over 120°C will result in damage to the carrier.



EPP180S

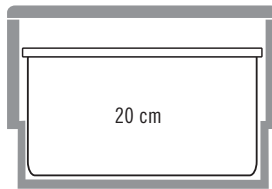

25,5 L

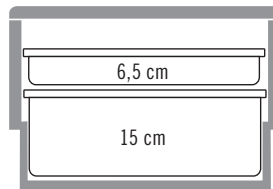

28 L

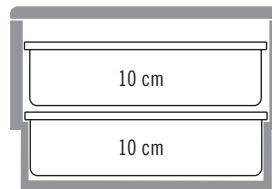

26 L

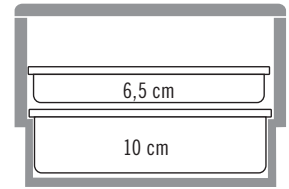

21,5 L

Front Loaders

EPP300

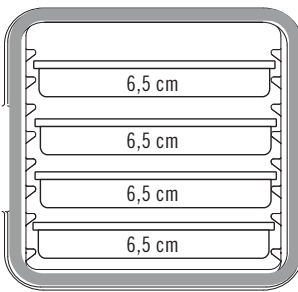

34 L

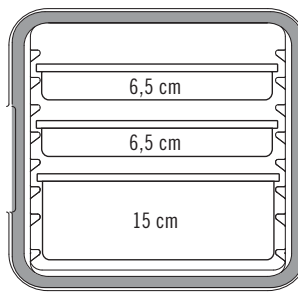

36,5 L

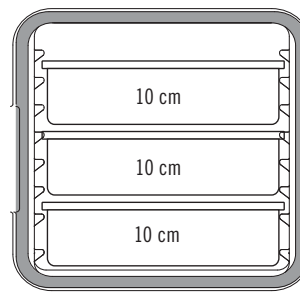

39 L

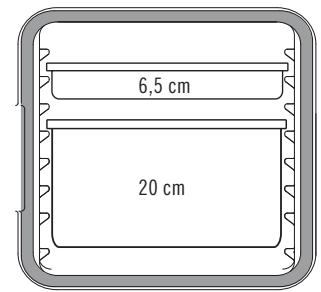

34 L

EPP400

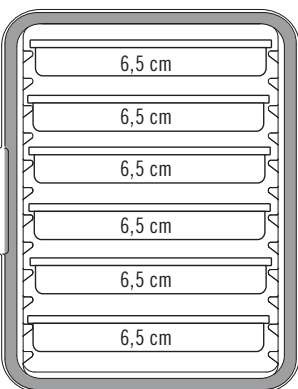

51 L

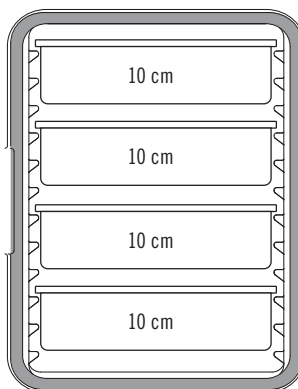

52 L

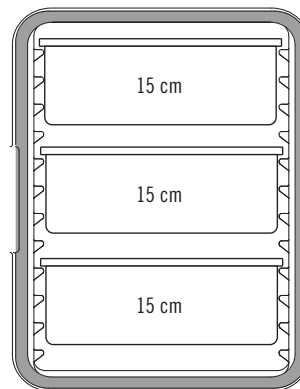

58,5 L

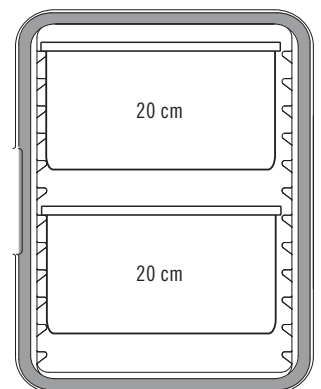

51 L

INSULATED BEVERAGE CONTAINERS



- Use to hold, transport and serve hot or cold beverages.
- One piece, seamless double-wall polyethylene with thick foam insulation.
- Sturdy latches secure lids tightly and will never rust.
- Drip-proof recessed spigot for easy self-serve access.
- Stack units on riser to fill large cups or coffee pots.
- Sta-stack interlocking ensures stable stacking during transport and storage.

Easy Serve Dispenser Color:
Black (110).

UC1000 covered by U.S. Patent
D 403,916.

Vent Cap patent pending.

350LCD Camtainer not NSF.



Vent Cap

Equalizes pressure. Makes the opening of the container much easier.

E-Z Grip Molded-in Handles

For comfortable, safe transporting.

Camtainer Cover

Durable and attractive covers extend the life of your Camtainers and fit in any serving environment.

Personalization available. Contact your Cambro representative for details. (Models for covers on next page.)



Recessed Faucet

Accommodates larger cups. Allows even dispensing and eliminates drips. Two positions: One for continuous pouring and one for individual dispensing.



Molded-in Metal Backing Plates

Prevents latches from breaking away from the container.



Stack beverage servers during storage and transporting to save space.

Stacking options:

- 100LCD with 100LCD
- All 250, 350 and 500 units
- UC1000 and 1000LCD

Hot

250LCD	87°C	84,5°C	82°C	79°C	77°C
--------	------	--------	------	------	------

UC250	88°C	85,5°C	84°C	82°C	80°C
-------	------	--------	------	------	------



Cold

250LCD	1°C	1,5°C	2°C	3°C	4°C
--------	-----	-------	-----	-----	-----

UC250	0,5°C	1°C	1°C	1,5°C	2°C
-------	-------	-----	-----	-------	-----



Ultra Camtainers®

Feature wide nylon latches which are easy to open and close with one hand.



Camtainers®

Feature sturdy plastic latches that secure lids tightly and will never rust.

Ultra Camtainers®

Choose from three sizes for beverage service. A contemporary line, featuring two wide nylon latches per unit that are easy to open and close.



CODE	UC250	UC500	UC1000
CAPACITY	10,4 L	19,9 L	39,7 L
210 ML. CUPS	50	96	192
EXTERIOR DIMENSIONS D x W x H	42,5 x 30 x 50 cm	42,5 x 30 x 68 cm	52 x 41,5 x 65,5 cm
FITS CAMDOLLY	CD100H, CD1826H, CD300H, CD100HB, CD300HB, CD100	CD100H, CD1826H, CD300H, CD100HB, CD300HB, CD100	CD300H, CD1826H, CD2020H, CD100HB, CD300HB, CD1826MTCHB, CD300, CD2020
CAMTAINER COVER	UC250CVR	UC500CVR	UC1000CVR

Case Pack: 1 **Colors:** Navy Blue (186), Slate Blue (401), Coffee Beige (157), Dark Brown (131), Brick Red (402), Green (519), Black (110), Granite Grey (191), Granite Green (192), Granite Sand (194). **Cover Color:** Black (110). Venting plug is covered by US Patent D 553,717 S.

Camtainers®

The standard for many caterers, choose from four sizes for beverage service and one model without a spigot for soup service. Four sturdy plastic latches on each unit open and close easily and will never rust.



CODE	100LCD	250LCD	500LCD	1000LCD	350LCD (SOUP)
CAPACITY	5,7 L	9,5 L	17,9 L	44,5 L	12,7 L
210 ML. CUPS	27	45	85	214	60
SPIGOT	YES	YES	YES	YES	—
EXTERIOR DIMENSIONS D x W x H	29 x 26,5 x 44 cm	42 x 23 x 47 cm	42 x 23 x 62 cm	53 x 41,5 x 63 cm	42 x 23 x 47 cm
FITS CAMDOLLY	CD1420	CD100H, CD1826H, CD300H, CD2020H, CD100HB, CD300HB, CD1826HB, CD2020HB, CD100, CD2020	CD100H, CD1826H, CD300H, CD2020H, CD100HB, CD300HB, CD1826HB, CD2020HB, CD100, CD2020	CD300H, CD1826H, CD2020H, CD100HB, CD300HB, CD1826MTCHB, CD300, CD2020	CD100H, CD1826H, CD300H, CD2020H, CD100HB, CD300HB, CD1826HB, CD2020HB, CD100, CD2020
CAMTAINER COVER	—	250LDCVCR	500LDCVCR	1000LDCVCR	—

Case Pack: 1 **Colors:** Navy Blue (186), Slate Blue (401), Coffee Beige (157), Dark Brown (131), Brick Red (402), Green (519), Black (110), Hot Red (158). **Cover Color:** Black (110). Venting plug is covered by US Patent D 553,717 S.

Camserver® – Holds The Heat for Hours.

- A front-of-house beverage server for hot or cold beverages that does not require canned heating.
- Double-wall polyethylene shell with thick foam insulation retains temperatures for hours.

Colors: Black (110), Dark Taupe (417), Granite Grey (191).



Convenient top-fill opening for fast replenishment without removing lid.

CODE	EXTERNAL DIM. H x W x D	CAPACITY	210 ML CUPS	CASE PACK
CSR3	60 x 34 x 46,5 cm	11,5 L	54	1
CSR5	71 x 34 x 46,5	19	91	1

CSR3 Shown in Dark Taupe Height is approximate 18 cm from counter to spigot.



CSR5 Shown in Black

HANDWASH ACCESSORY – FOR CAMTAINERS® & ULTRA CAMTAINERS®



Shown with 500LCD Camtainer®.

- Set up a Handwashing Station quickly and easily on or off premise.
- Convenient and economical way to meet health department hand washing requirements.
- Attaches to Camtainers 250LCD, 500LCD or Ultra Camtainers UC250, UC500.
- Includes four Handwash Only labels and an Easy Serve Dispenser lever.

Handwash Accessory Stocking Colors: Dark Brown (131), Black (110).

Easy Serve Dispenser Color: Black (110).

Riser Colors: See optional accessories with Camtainers.

Pail with Bail Color: White (148).

Handwash Accessory is covered by the following U.S. Patent D 506,634 S & D 506,899 S.



CODE	HWAPR	HWATD
DESCRIPTION	With paper towel roll holder	With multi-fold paper towel dispenser
FITS	250LCD, 500LCD, UC250, UC500	250LCD, 500LCD, UC250, UC500

Optional Accessories

CODE	DESCRIPTION
R500LCD	Riser
PWB22	Pail with Bail
LCDES	Easy Serve

Optional Accessories



CODE	R500LCD	R1000LCD	LCDCH	LCDCH10	LCDES
DESCRIPTION	Riser	Riser	Condiment Holder	Condiment Holder	Easy Serve Dispenser
EXTERIOR DIM. D x W x H	41,5 x 23 x 12 cm	49,5 x 39 x 11,5 cm	42 x 22 x 13 cm	51 x 41 x 12 cm	—
FITS	250LCD, 500LCD, UC250, UC500	1000LCD, UC1000	250LCD, 500LCD, UC250, UC500	1000LCD, UC1000	LCD Spigots UC Spigots

Case Pack: 1 **Colors:** Coffee Beige (157), Dark Brown (131), Black (110). **Easy Serve Color:** Black (110).

Hydration Station

Cart with two 19 L beverage servers with covers can be used at full height with three shelves or at lower height with two shelves.



CODE	HYDRASTATIONPKG**
DESCRIPTION	1- KD Utility Cart, 2- 500LCD beverage servers, 2- Easy Serve Dispensers and 2- black personalized beverage server covers stating "WATER"
DIMENSIONS* W x D x H	101,6 x 53,96 x 147,32 cm

Case Pack: 1 **Camtainer and Cover Color:** Black (110).

* Dimensions based on 3 shelf cart with Camtainers on top shelf.

** Ships in 7 separate cartons.

With 2-shelf set-up, approximate distance from floor to spigot is 60 cm; with 3-shelf set-up: 94 cm.

BEVERAGE SERVICE CARTS

- Ideal for breakfast, coffee or snack service.
- Use top counter to hold Cambro Beverage Servers, Versa Organizer Bins or Display Trays with Covers for food.
- Store drinkware, additional food items or other supplies in open compartment.
- Insulated cabinets hold hot or cold food in full, 1/2 or 1/3 size food pans or on Cambro Metric Camtrays® (3253).

Colors: Slate Blue (401), Granite Grey (191), Granite Green (192).

See Organizer section for more information on Organizer Bins.

See Camtainer section for more information on Camtainers.

Wire Rack Color: Silver (000).

See Cold Pack section for more information on Cold Packs.

15,2 cm Casters: 2 fixed, 2 swivel, 1 with brake.

For complete specifications, call or write Cambro.



Beverage Service Cart is designed to hold Beverage Containers at point of service only. A dolly or hand truck with safety strap is recommended for moving Beverage Containers over longer distances or uneven surfaces.



MDC24F



MDC24 has recessed top that holds 3 each 3,8 Liters 100LCD Camtainers and stacked Condiment Bins & Wire Rack with 3253 trays.

CODE	EXTERIOR DIM. L x W x H	CASE PACK
MDC24	113 x 76 x 112 cm	1
MDC24F	113 x 76 x 112	1
OPTIONAL ACCESSORIES		
Organizer Bin		
5412CBP	30,5 x 13 x 11	12
Camtainer®		
100LCD	26,5 x 30 x 44	1
Wire Rack		
MDC24R	58,4 x 43,2 x 35,5	1
Camchiller®		
CP1220	53 x 33 x 3,8	1

The use of racks in the MDC24 and MDC24F carts will allow the following configuration of pans or trays, per compartment:

DESCRIPTION	GN 1/1	GN 1/2	GN 1/3
6,5 cm Pans	(4) 12CW	(8) 22CW	(12) 32CW
10 cm Pans	(3) 14CW	(6) 24CW	(9) 34CW
15 cm Pans	(2) 16CW	(4) 26CW	(6) 36CW
20 cm Pans	(1) 18CW**	(2) 28CW**	(3) 38CW**

** With room for 6,5 cm or 10 cm pan above 15 cm pan.
10 each 3253 Metric Camtrays®.

Compartment Dimensions

	W	D	H
Shelf Compartment	96,5 cm	64 cm	25,4 cm
Holding Compartments	44,5 cm	60,3 cm	36 cm

Venting plug is covered by US Patent D 553,717 S.

MDC24R Wire Rack

Wire Rack (sold separately) to organize pans and trays in the cart. Rack holds Full, 1/2 and 1/3 size Food Pans and 3253 trays. When placed in cart's core area, the rack allows room on either side of pan positions for Cambro's CP1220 Camchillers® one on each side.



INSULATED TOP LOADING CAMCARRIERS® TO TRANSPORT GASTRONORM FOOD PANS



- Top-loading food pan carriers hold, transport and serve a single full-size pan of hot or cold food.
- Sturdy and durable, seamless polyethylene or polypropylene with thick foam insulation.
- Molded-in handles on all four sides for easy carrying and handling.
- Use with divider bars to hold multiple fractional pans.
- Pans are easy to remove using finger notches.
- Carriers interlock and stack for transporting and storing.

UPCS Colors: Dark Brown (131), Speckled Grey (480), Coffee Beige (157), Black (110).

MPC and MPCHL Colors: Navy Blue (186), Slate Blue (401), Coffee Beige (157), Dark Brown (131), Brick Red (402), Green (519), Black (110), Hot Red (158).

*Polypropylene dough boxes are safe for use in high temperature dishwashers.

UPC Colors: Slate Blue (401), Dark Brown (131), Black (110), Granite Grey (191), Granite Green (192).

Camdolly® Colors: Coffee Beige (157), Dark Brown (131), Black (110), Slate Blue (401), Grey (180).

Divider Bar Colors: White (148), Clear (135).

See Food Pan Section for pricing and ordering information.

Note: Place food pans on rails. Pans should not be placed on the floor of a Camcart or Camcarrier® cavity.

Note: Best results will be achieved by loading food pans between 82° to 88°C. Loading metal food pans over 121°C may result in damage to the carrier or cart.



Stacking and storage reduced by 35%!

Hot

UPC160	87°C	85°C	83°C	81°C	79°C
UPCS160	87°C	85°C	83°C	81°C	79°C
UPCSS160	87°C	85°C	83°C	81°C	79°C



Cold

UPC160	0°C	1°C	2°C	2°C	2,5°C
UPCS160	0°C	1°C	2°C	2°C	2,5°C
UPCSS160	0°C	1°C	2°C	2°C	2,5°C



Camcarrier®

One-piece, seamless polyethylene construction, airtight removable gasket and sturdy plastic latches.



CODE	240MPC
COMPARTMENT CAPACITY	1 GN 1/2 – 10 cm deep pan
EXTERIOR DIMENSIONS W x D x H	42 x 35 x 19 cm
Case Pack:	1 240MPC No Divider Bar.

S-Series

Durable polypropylene construction, built in seal and wide, nylon latches.
Contemporary appearance and superior holding performance at an economical price.



CODE	UPCS140	UPCS160**	UPCS180	UPCSS160*
COMPARTMENT CAPACITY	1 GN 1/1 – 10 cm deep pan	1 GN 1/1 – 15 cm deep pan	1 GN 1/1 – 20 cm deep pan	1 full size 15 cm deep pan
EXTERIOR DIM. W x D x H	64 x 43,5 x 22 cm	64 x 43,5 x 26 cm	64 x 43,5 x 30,5 cm	62,5 x 42 x 28 cm
FITS CAMDOLLY®	CD160	CD160	CD160	CD160

Case Pack: 1 * UPCSS160 available in Dark Brown (131) and Coffee Beige (157). ** UPCS160 Cannot be used with Camchiller.
Temperature Maintenance Tool for UPCSS160 Only: CP1220 and CP1210 Camchiller®

Ultra Pan

One-piece, seamless polyethylene construction, airtight removable gasket and wide, nylon latches.



CODE	UPC140	UPC160	UPC180
COMPARTMENT CAPACITY	1 GN 1/1 – 10 cm deep pan	1 GN 1/1 – 15 cm deep pan	1 GN 1/1 – 20 cm deep pan
EXTERIOR DIM. W x D x H	63 x 44 x 21 cm	63 x 44 x 26 cm	63 x 44 x 30,5 cm
FITS CAMDOLLY	CD100H, CD1826HB, CD160	CD100H, CD1826HB, CD160	CD100H, CD1826HB, CD160

Case Pack: 1

100 Series

Store and stack food pans or place food directly in compartment. The 100MPCHL model has a hinged serving lid.



CODE	100MPC	100MPCHL	UPC100
COMPARTMENT CAPACITY	3 GN 1/1 – 6,5 cm deep pan or 2 GN 1/1 – 10 cm deep pans or 1 GN 1/1 – 15 or 20 cm deep pan	1 GN 1/1 – 20 cm deep pan	3 GN 1/1 – 6,5 cm deep pans or 2 GN 1/1 – 10 cm deep pans or 1 GN 1/1 – 15 cm or 20 cm deep pan
EXTERIOR DIM.	68 x 45 x 38 cm	68 x 45 x 39,5 cm	68 x 46 x 40 cm
INTERIOR DIM. W x D x H	55 x 35 x 20,5 cm	55 x 35 x 20,5 cm	56,5 x 33 x 20,5 cm
BULK CAPACITY*	38 L	38 L	38 L
FITS CAMDOLLY	CD100H, CD1826MTC, CD100HB, CD1826MTCHB, CD100, CD2028	CD100, CD100H, CD100HB	CD100H, CD1826MTC, CD100HB, CD1826MTCHB, CD100, CD2028

Case Pack: 1 * Without using food pans. 100MPC, 100MPCHL and UPC100 No Divider Bar.

Accessories

CODE	OVERALL EXTERIOR DIMENSIONS	CASE PACK
Divider Bars for Food Pans		
DIV12	32,38 cm length	3
DIV20	53,02 cm length	3

* Not for use in UPCSS1600.



CAMCHILLER®, THERMOBARRIER® AND CAMWARMER®



Camchiller

- An easy-to-use, cold food holding temperature tool.
- Extend cold holding time or enhance safe holding below 5°C when frequent access is required.
- Freeze first then use to pre-chill cabinet before loading.

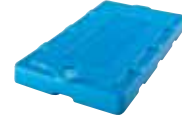
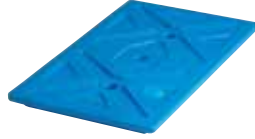
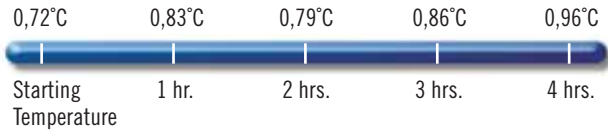

CODE	CP1220 (GN FULL SIZE)	CP1210 (GN HALF SIZE)	CP814 (20 x 36 CAMCHILLER)
FITS INTO	UPCSS160, 300MPC, 1318MTC, UPC400, UPC400SP, UPCS400, UPC600, UPC800, UPC800SP, UPC1200, UPC1600, CVC72, CVC724, all Combo Cart® Plus and CamKiosks®*	300MPC, 1318MTC, UPC400, UPCS400, UPC400SP, UPC600, UPC800, UPC800SP, UPCS140, UPCS160, UPCS180, CVC724*, CVC72* and all CamKiosks*	12186CW, 12186P, 12189CW, 12189P, CVC724, CVC72, CVC55, and all CamKiosks*
DIMENSIONS L x W x H	53 x 33 x 3,8 cm	32,4 x 26,4 x 3,8 cm	35,56 x 20,32 x 3,8 cm
QUANTITY PER CAVITY	1 (*2 per cavity)	1 (*2 per top wells)	1

Case Pack: 1 Color: Cold Blue (159).

ThermoBarrier

- A highly valuable yet economical temperature maintenance tool for caterers.
- Use to minimize empty space and food temperature loss within a partially loaded compartment.

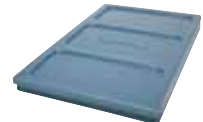
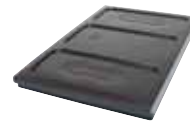

CODE	300DIV	400DIV	1200DIV	1600DIV
FITS INTO	300MPC, UPC600, 1318MTC	UPC400, UPC800, UPC400SP, UPCS400, UPC800SP	UPC1200, CVC72, CVC724	UPC1600, CamKiosk, UPC1600SP
QUANTITY PER COMPARTMENT	1	1	2	2
DIM. L x W x H	53 x 33 x 2,5 cm	54 x 33 x 3,8 cm	53 x 33,5 x 3,5 cm	53 x 33,5 x 3,8 cm
COLOR	Coffee Beige (157)	Grey (180)	Dark Brown (131)	Slate Blue (401)
CASE PACK	1	1	2	2



Camwarmer

- Use for added insurance to keep hot foods hot during holding and transporting.
- Keep in cabinet with hot foods to extend holding time or enhance safe holding above 65°C when frequent access is required.



CODE	1210PW
FITS INTO	300MPC, 1318MTC, UPC400, UPCS400, UPC600, UPC800
DIMENSIONS L x W x H	34 x 27,5 x 4 cm
CASE PACK	1

Color: Granite Grey (191)



UPC400 with Camwarmer.
Two Camwarmers recommended per cavity.

TEMPERATURE MAINTENANCE – OPTIMIZE FOOD HOLDING PERFORMANCE

Camchiller® – GN 1/1 Size and GN 1/2 Size

• Use to:

- Pre-chill cabinet cavity.
- Hold package food in food pan wells. (Half Size Only)
- Maximize cold food holding.
- Minimize open cavity space.

• Easy to use:

1. Freeze 8 hours.
2. Slide one or two on top rails and pre-chill cavity 15-20 minutes.
3. Load in pans of pre-chilled food below Camchiller. (A)
4. Move pans and Camchiller down as food is removed. (B)

COLD HOLDING

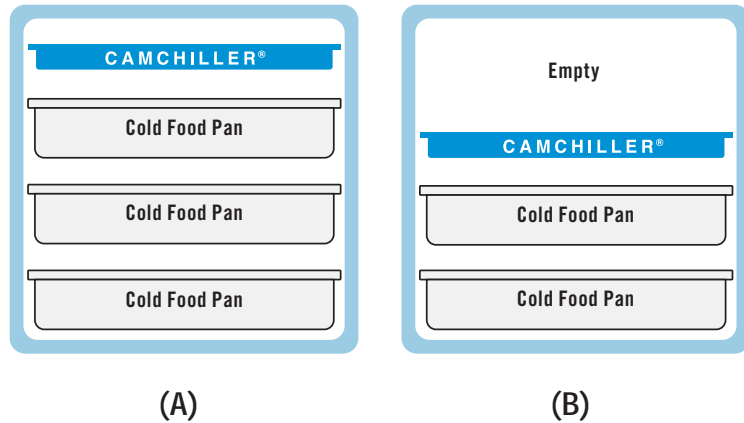

ThermoBarrier® – GN 1/1 Size

• Use to:

- Hold hot and cold food in same cabinet cavity.
- Minimize open cavity space.

• Easy to use:

1. Slide between hot food on top and cold food on bottom. (A)
2. Slide under hot food loaded in upper cavity space. (B)
3. Slide above cold food loaded into lower cavity space. (C)

HOT AND COLD HOLDING

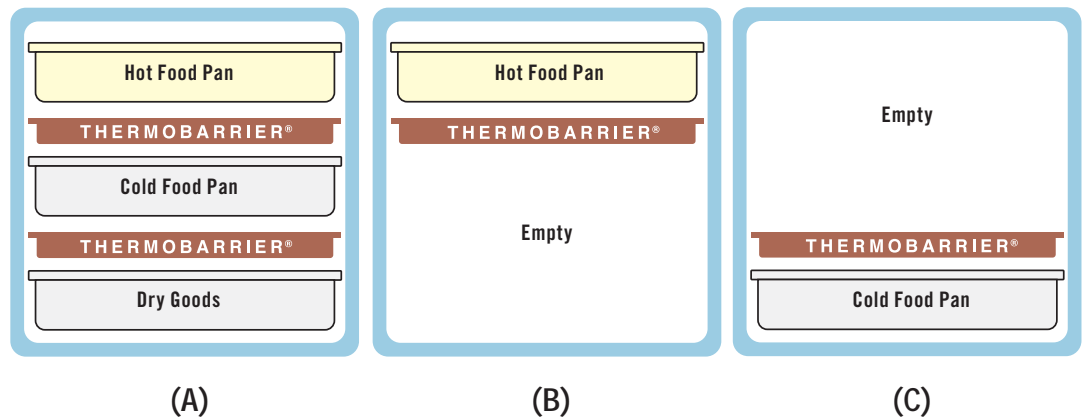

Camwarmer® – GN 1/2 Size

• Use to:

- Pre-heat cabinet cavity.
- Maximize hot food holding.
- Minimize open cavity space.

• Easy to use:

1. Heat in 180°C oven for 45 minutes.
2. Slide two Camwarmers on bottom rails and pre-heat cavity 15-20 minutes. (or place on high heat food pan lid or sheet pan)
3. Load in pans of pre-heated food above Camwarmers. (A)
4. Move pans and Camwarmers up as food is removed. (B)

HOT HOLDING

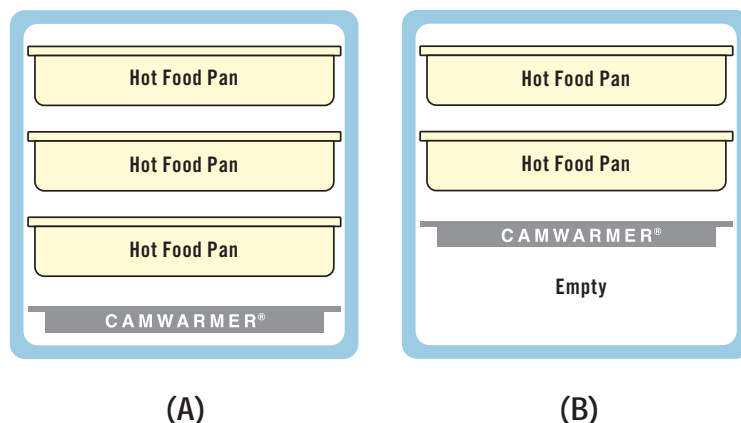

INSULATED FRONT LOADING 300MPC AND UPC400 TO TRANSPORT GASTRONORM FOOD PANS

- Durable and dependable front-loading food pan carriers.
- Hold multiple pans of hot or cold food at safe temperatures for hours.
- Seamless polyethylene with thick foam insulation.
- Airtight removable gasket provides a secure seal.

300MPC Colors: Navy Blue (186), Slate Blue (401), Coffee Beige (157), Dark Brown (131), Brick Red (402), Kentucky Green (519), Black (110), Hot Red (158).

UPC400 Colors: Navy Blue (186), Slate Blue (401), Coffee Beige (157), Dark Brown (131), Black (110), Granite Grey (191), Granite Green (192), Granite Sand (194).

▲ Camdolly Colors: Slate Blue (401), Coffee Beige (157), Dark Brown (131), Black (110).

Note: Place food pans on rails. Pans should not be placed on the floor of a Camcarrier® cavity. Please use specified food pan sizes.

Note: Best results will be achieved by loading food pans between 82° to 88°C. Loading metal food pans over 121°C may result in damage to the carrier or cart.

See Food Pan section for pricing and ordering information.

UPC400 is covered by US Patent D 392,158.

Venting plug is covered by US Patent D 553,717 S.



Hot

UPC400	87,8°C	85,6°C	84,5°C	82,8°C	81,7°C
300MPC	86°C	83°C	81°C	79°C	77°C

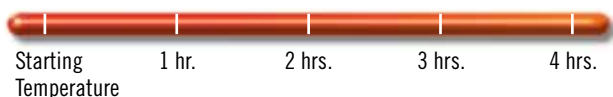

Cold

UPC400	0,3°C	0,8°C	0,9°C	1,2°C	1,4°C
300MPC	1°C	1,5°C	2°C	2,5°C	3°C



UPC400 & CD400



300MPC



CODE	300MPC	UPC400 / UPC400SP**
EXTERIOR DIM. W x D x H	42,5 x 62 x 57 cm	46 x 63,3 x 62 cm
INTERIOR DIM. W* x D x H	34 x 53,5 x 36 cm	33,5 x 53,3 x 49 cm

Case Pack: 1 * Rail to Rail ** Security Package (SP).

HOLDING CAPACITY:

PAN DEPTH	NUMBER OF GN 1/1 PANS 300MPC	UPC400
6,5 cm	4	6
10	3	4
15	2	3
20	1 +	2
	1 each 6,5 cm	

Also holds GN 1/2 and 1/3 size pans.

Optional Accessories

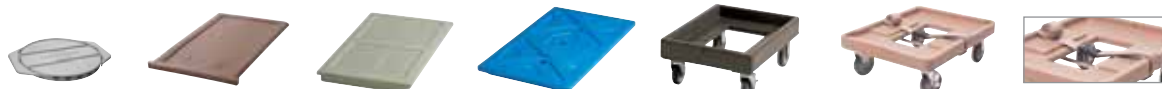

CODE	1210PW	300DIV	400DIV	CP1220	CD300*	CD400	400STP
DESCRIPTION	Camwarmer®	ThermoBarrier®	ThermoBarrier	Camchiller®	Camdolly®	Camdolly	Strap
EXTERIOR DIM. (CM)	34,9 x 27,6 x 4	53 x 33 x 2,5	54 x 33 x 3,8	53 x 33 x 3,8	49 x 65 x 26,5	71 x 53 x 23	500 Long
INTERIOR DIM. (CM)	—	—	—	—	43 x 59	63,5 x 46	—
COLOR	Granite Grey (191)	Coffee Beige (157)	Grey (180)	Cold Blue (159)	▲	▲	Beige (000)

Case Pack: 1 * Also available CD300H and CD300HB. See Camdolly section.

UPCS400 ULTRA PAN CARRIER® S-SERIES TO TRANSPORT GASTRONORM FOOD PANS

- Ultra dependable, ultra durable front-loading pan carrier.
- Holds multiple pans of hot or cold food for hours.
- Durable polyethylene shell and thick, polyurethane foam insulation.

◆ **UPCS400 Colors:** Slate Blue (401), Speckled Grey (480), Dark Brown (131).



▲ **CD400 Colors:** Coffee Beige (157), Dark Brown (131), Black (110), Slate Blue (401).

Casters: 12,7 cm 2 fixed, 2 swivel, 1 with brake.

Note: Best results will be achieved by loading food pans between 82° to 88°C. Loading metal food pans over 121°C may result in damage to the carrier or cart.



Stacks with both UPCS400. Fits on CD400 Camdolly, or optional casters may be added for smooth ground transport.

HOLDING CAPACITY:

PAN DEPTH	NUMBER OF GN 1/1 PANS
6,5 cm	6
10	4
15	3
20	2

Also holds GN 1/2 and 1/3 size pans.



EASY CONTENT AND ROUTING LABELING
Menu clip reduces need to open door.

CONVENIENT

Integrated pan-staging area eases service (not for use during transport).



ERGONOMIC DESIGN

Unbreakable, ergonomic, molded-in handles for comfortable two-person carrying.

TEMPERATURE RETENTION

Polyurethane insulation keeps hot food hot and cold food cold.



EASY TO CLEAN

Door removes for easy cleaning.

QUICK ACCESS

Single, 23 cm nylon latch for quick and secure opening and closing.



PRESSURE CONTROL

Built-in vent equalizes pressure and releases steam.

BUILT-IN SEAL

Built-in seal eliminates need for removable gasket.

Hot

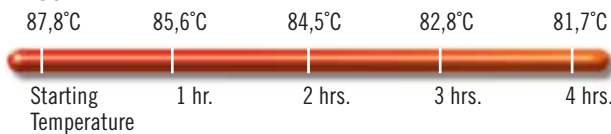

Cold

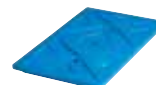
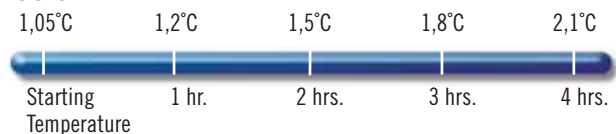

CODE	UPCS400	UPCS400CK	1210PW	400DIV	CP1220	CD400	400STP
DESCRIPTION	Insulated Carrier	Caster Kit*	Camwarmer®	ThermoBarrier	Camchiller	Camdolly®	Strap
EXTERIOR DIM. (CM)	63,5 x 46 x 63	∅ 12,7	34,9 x 27,6 x 4	54 x 33 x 3,8	53 x 33 x 3,8	71 x 53 x 23	500 cm Long
INTERIOR DIM. (CM)	53,5 x 33,5 x 48,6	—	—	—	—	63,5 x 46	—
COLOR	◆	—	Granite Grey (191)	Grey (180)	Cold Blue (159)	▲	Beige (000)

Case Pack: 1 * Optional Caster Kit: 2 fixed, 2 swivel, 1 w/ brake.

ULTRA CAMCARTS® TO TRANSPORT GASTRONORM FOOD PANS



- Double-compartment, high-capacity carts hold and transport hot or cold food.
- Tough, polyethylene shell and thick foam insulation throughout cabinet and between compartments.
- Airtight removable gaskets maintain safe food temperatures for hours.
- Easy to maintain and won't dent, crack, rust, chip or break.
- Durable nylon door latches open easily and close securely.
- Full-swing doors open to the side of the cart for easy loading and unloading.
- Molded-in handles ensure easy maneuvering.
- Molded-in bumpers minimize damage to walls, furniture and other equipment.

Colors: Navy Blue (186), Slate Blue (401), Coffee Beige (157), Dark Brown (131), Brick Red (402), Green (519), Black (110), Hot Red (158), Granite Grey (191), Granite Green (192), Granite Sand (194).

Note: Place food pans on rails. Pans should not be placed on the floor of a Camcart cavity. Please use specified food pan sizes.

Note: Best results will be achieved by loading food pans between 82° to 88°C. Loading metal food pans over 121°C may result in damage to the carrier or cart.

Venting plug is covered by US Patent D 553,717 S.

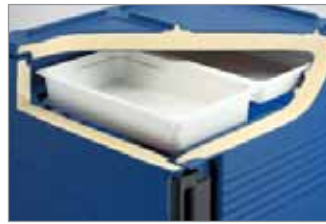

Polyurethane insulation keeps hot food hot and cold food cold.



Shown with optional HD casters.

Security Package (SP)

Specially designed for operations where safety and security are a top priority.

- Tamper resistant fasteners.
- Non-removable doors.
- Lockable hasp on each door. (padlocks not included)
- Heavy duty (HD) casters with chassis plates mounted with tamper resistant bolts.

Marine rail is designed for use during service, not transport.



TOTAL CART HOLDING CAPACITY	UPC600	UPC800	UPC1200	UPC1600
Full Size Food Pans				
6,5 cm deep	8 pans	12 pans	16 pans	24 pans
10 cm deep	6 pans	8 pans	12 pans	16 pans
15 cm deep	4 pans	6 pans	8 pans	12 pans
20 cm deep	2 pans + 2 each 10 cm pans	4 pans	4 pans	8 pans
Camtray®				
3253	12 trays	12 tray	12 trays	48 trays
2632	24 trays	48 trays	—	—
2025	—	—	12 trays	24 trays

See Food Pan and Camtray Section for ordering information.
*Based on 3,8 cm spacing between trays.

Hot

UPC600	86,8°C	84,3°C	82,5°C	80,8°C	79,3°C
UPC800	87,7°C	85,5°C	84,2°C	82,9°C	81,7°C
UPC1200	85,6°C	82,1°C	80,1°C	78,3°C	77,2°C
UPC1600	87,1°C	85,9°C	85,1°C	84,3°C	83,7°C

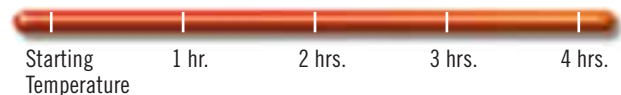

Cold

UPC600	0,6°C	1,1°C	1,4°C	1,8°C	2,1°C
UPC800	0,3°C	0,8°C	0,9°C	1,2°C	1,4°C
UPC1200	0,5°C	0,9°C	1,1°C	1,3°C	1,4°C
UPC1600	0,6°C	1,0°C	1,2°C	1,5°C	1,5°C





UPC600

CODE	UPC600
DESCRIPTION	Base model
EXTERIOR DIM. W x D x H	52 x 69 x 114,5 cm
COMPARTMENT DIM.	34 x 54 x 35,5 cm
Case Pack: 1 Casters: 12,7 cm, 2 fixed, 2 swivel, 1 with brake.	



UPC800

CODE	UPC800	UPC800SP
DESCRIPTION	Base model	Security package
EXTERIOR DIM. W x D x H	52 x 69 x 137 cm	52 x 69 x 137 cm
COMPARTMENT DIM.	33 x 54,5 x 48,5 cm	33 x 54,5 x 48,5 cm
Case Pack: 1 Casters: 15,2 cm, 2 fixed, 2 swivel, 1 with brake.		
Heavy Duty (HD) Casters: 15,2 x 3,8 cm, 2 fixed, 2 swivel with brake casters.		



UPC1200

CODE	UPC1200
DESCRIPTION	Base model
EXTERIOR DIM. W x D x H	72,5 x 82 x 116 cm
COMPARTMENT DIM.	54 x 66,5 x 34,5 cm
Case Pack: 1 Casters: 15,2 cm, 2 fixed, 2 swivel, 1 with brake.	



UPC1600

CODE	UPC1600	UPC1600HD	UPC1600SP*	UPCGL1600SP*
DESCRIPTION	Base model	Base model with HD casters	Security package	Security package, gasketless
EXTERIOR DIM. W x D x H	71,5 x 82 x 135 cm	73 x 84,7 x 138,4 cm	71,5 x 82 x 135 cm	71,5 x 82 x 135 cm
COMPARTMENT DIM.	53,5 x 66,5 x 53,5 cm	53,5 x 66,5 x 53,5 cm	53,5 x 66,5 x 53,5 cm	53,5 x 66,5 x 53,5 cm

Case Pack: 1 Casters: 15,2 cm, 2 fixed, 2 swivel, 1 with brake. Heavy Duty (HD) Casters: 15,2 x 5,08 cm 2 fixed, 2 swivel with brake casters.

*Security Package (SP) have lock-in hinge pins and latches and wheels are attached with tamper resistant screws.



Optional Accessories

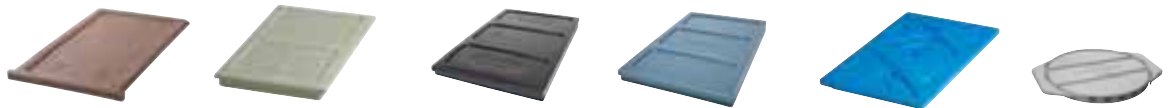

CODE	300DIV	400DIV	1200DIV	1600DIV	CP1220	1210PW
DESCRIPTION	ThermoBarrier®	ThermoBarrier	ThermoBarrier	ThermoBarrier	Camchiller®	Camwarmer®
EXTERIOR DIM. L x W x H	53 x 33 x 2,5 cm	54 x 33 x 2,5 cm	53 x 33,5 x 3,5 cm	53 x 33,5 x 3,8 cm	53 x 33 x 3,8 cm	34 x 27,5 x 4 cm
FITS	UPC600	UPC800, UPC800SP	UPC1200	UPC1600	UPC600, UPC800, UPC800SP, UPC1200, UPC1600, UPC1600SP	UPC600, UPC800, UPC800SP
COLOR	Coffee Beige (157)	Grey (180)	Dark Brown (131)	Slate Blue (401)	Cold Blue (159)	Granite Grey (191)

Case Pack: 1 1200DIV / 1600DIV Case Pack: 2

TRANSPORTER CAPACITY GUIDE

Loading Examples for Cambro® Insulated Transporters

TOP LOADERS

UPC140-UPC180
UPCS140-UPCS180
UPCSS160

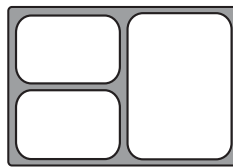

For a 3-course meal:
2 x GN 1/4
1 x GN 1/2
1 DIV12 divider bar
(approx. 14 meals)

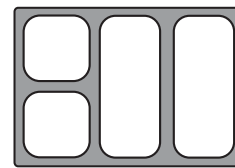

For a 4-course meal:
2 x GN 1/6
2 x GN 1/3
2 DIV12 divider bars
(approx. 14 meals)

TOP LOADERS

100 series
100MPC
UPC100

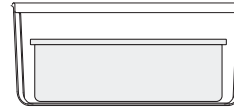
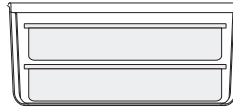
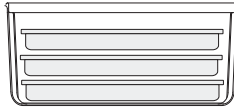

FRONT LOADERS

300MPC
UPC600 (x2)
UPC1200 (x4)

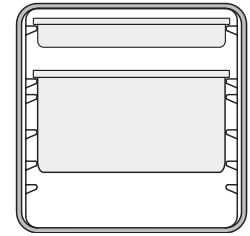
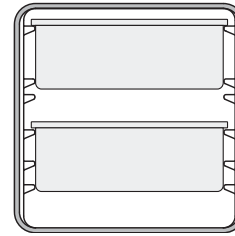
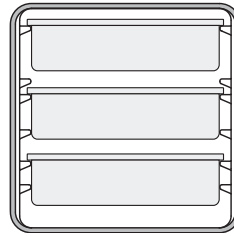
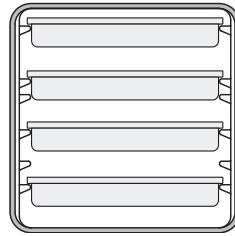
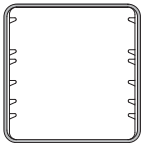

FRONT LOADERS

UPC400
UPCS400
UPCH400(2)
UPC800 (x2)
UPCH800(2) (x2)
UPC1600 (x4)
UPCH1600(2) (x4)

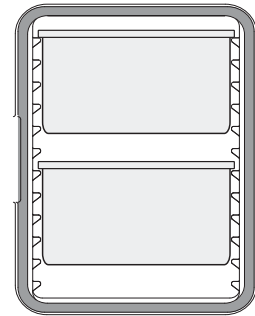
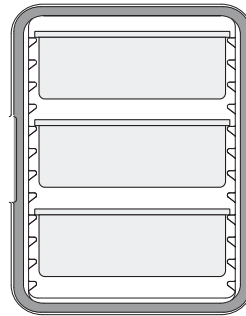
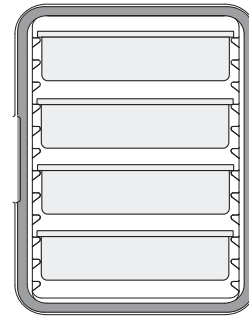
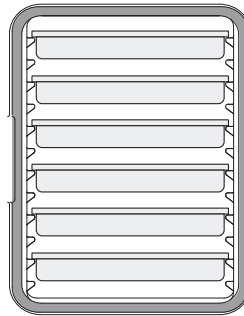

CAMCARRIERS® AND CAMCARTS® FOR SHEET PANS

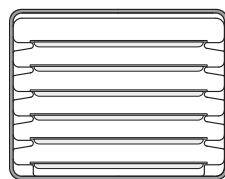
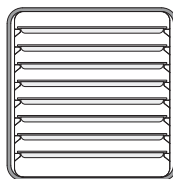

1826DTC (x4)

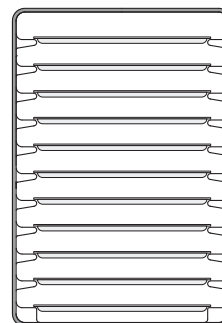
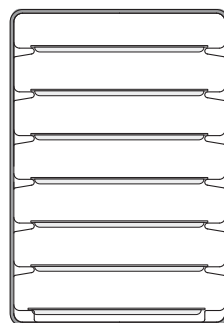

Camtherm Tall (x2)

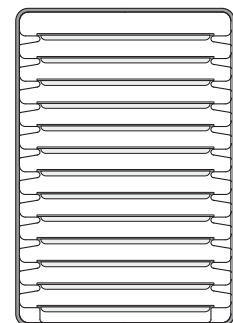

SUMMARY OF GN CONTAINER SIZES

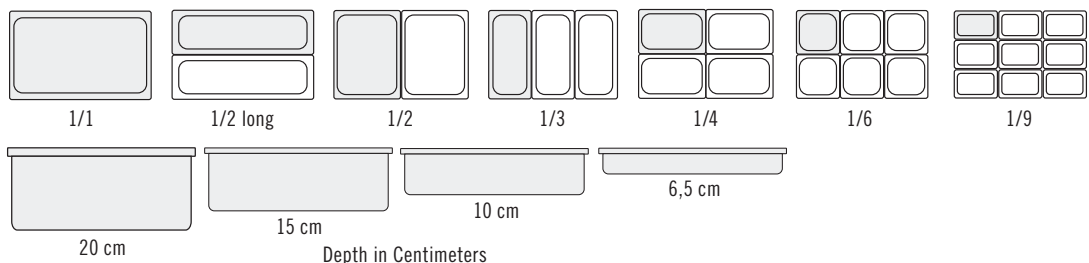

ULTRA PAN CARRIER® AND ULTRA CAMCART® H-SERIES

- Designed for both electric hot holding and non-electric transport.
- Gentle, 65° to 74°C non-radiant heat will not cook food and maintains food moisture.
- Holds a wide variety of foods such as pasta, bone-in fried chicken, and double-crust pies.
- One hour preheat time from room temperature and three minute recovery.
- Energy consumption is substantially less than comparable metal cabinets.
- Will not rust or dent like metal cabinets, is more economical, and is easy to maneuver.
- All UPCH models have been tested to maintain safe, hot food temperatures, for up to 4 hours when unplugged.
- Models with only the top heated door offer unique versatility with an electric hot holding cabinet on top and passive hot or cold food holding on the bottom.
- Heated door kits also sold separately to retrofit UPC400, UPC800 and UPC1600.

Colors: Granite Gray (191), Black (110), Granite Green (192), Slate Blue (401), Dark Brown (131).

Casters: 15,2 cm 2 fixed, 2 swivel, 1 with brake.



Power On and Heat on Indicators

Communicate the Power and Heating status of the UPCH1600 unit. Know instantly when the compartment has reached target temperature.



Vents

Consistent heating throughout the compartment is generated by vents that constantly circulate heat from front to back.



Tough Exterior

All UPCH units are made of tough, polyethylene with polyurethane foam insulation to keep heat in while keeping the exterior cool to the touch. Will not crack, dent, chip, rust or break.



Insulation

CFC-free, foamed-in place polyurethane foam insulation will hold temperature above 64°C for up to 4 hours when used unplugged.

ULTRA PAN CARRIER® AND ULTRA CAMCART® H-SERIES

Marine rail is designed for use during service, not transport.



UPCH4002



UPCH8002



UPCH16002

MODEL	UPCH400/ UPCH800 (110 VAC MODELS)	UPCH4002/ UPCH8002 (220 VAC MODELS)	UPCH1600 (110 VAC MODELS)	UPCH16002 (220 VAC MODELS)
Electrical Specifications				
REQUIRED VOLTAGE	110 – 120 VAC	200 – 230 VAC	110 – 125 VAC	200 – 230 VAC
MAXIMUM AMP.	2,0a	1,2a	4,6a	2,3a
WATTS	230w	265w	529	506w
HERTZ	50/60	50/60	50/60	50/60
PLUG TYPE	Nema 5-15P	Euro plug, CEE7	5-15P to C15RA	CEE7/7 to C15RA
POWER CORD LENGTH	2,7 m	2,7 m	2,7 m	2,7 m

Hot Holding When Unplugged

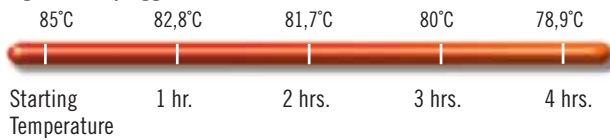

HOT HOLDING

65° – 74°C

WARM UP TIME

(from ambient to temperature)

1 hour

RECOVERY TIME*

(time to recover to temperature after door is held open for 30 seconds)

3 minutes

TRANSPORT TIME*

(after reaching temperature, amount of time unit can be held passively / unplugged until contents reach 65°C.)

4 hours+

*Based on test with 6 each, 15,24 cm deep H-pans with GripLids® filled with approx 14,2 L of 87,7°C water. (Temperatures are of the water not the air in the cart).

Capacity Guide

UPCH4002
UPCH8002 (x2)
UPCH16002 (x4)

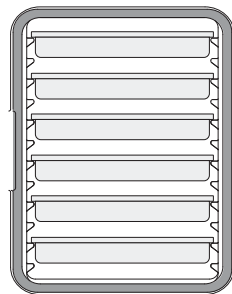

6 x 6,5 cm

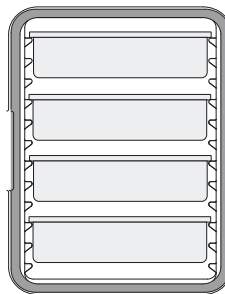

4 x 10 cm

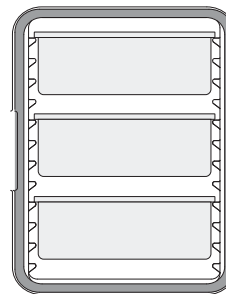

3 x 15 cm

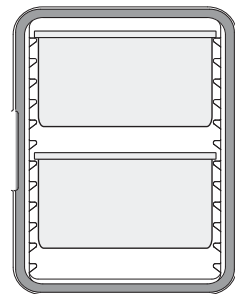

2 x 20 cm

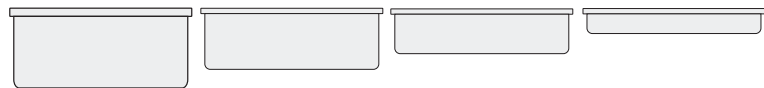

Food Pan Portion Guide

GN 1/1 Food Pan

DEPTH	20 cm	15 cm	10 cm	6,5 cm
SERVING PORTIONS PER PAN (1 CUP)	80	60	40	30

ULTRA PAN CARRIER® AND ULTRA CAMCARTS® H-SERIES

- Enables HACCP compliance by maintaining safe, hot food temperatures.
- UPCH400(2) models stack for storage or transporting on a Camdolly® with securing strap.

Colors: Granite Grey (191), Granite Green (192), Slate Blue (401), Black (110), Dark Brown (131).

CD400 Colors: Coffee Beige (157), Dark Brown (131), Black (110), Slate Blue (401), Grey (180).

Casters: 15,2 cm 2 fixed, 2 swivel, 1 with brake.

Note: If using metal food pans, cool to 120°C before placing onto rails.

Note: Place food pans on rails. Pans should not be placed on the floor of a Camcart cavity. Please use specified food pan sizes.

Vent Cap Patent Pending.



Security Package (SP)

Specially designed for operations where safety and security are a top priority.

- Tamper-resistant fasteners.
- Non-removable doors.
- Lockable hasp on each door (padlocks not included).
- Heavy duty (HD) casters with chassis plates mounted with tamper-resistant bolts.

CODE	DESCRIPTION	EXTERIOR DIMENSIONS W x D x H	COMPARTMENT DIMENSIONS W x D x H
UPCH1600SP	110V, Both doors heated	73 x 84,7 x 138,4 cm	53,5 x 66,5 x 53,5 cm
UPCH16002SP	220V, Both doors heated	73 x 84,7 x 138,4	53,5 x 66,5 x 53,5

CODE	DESCRIPTION	EXTERIOR DIMENSIONS W x D x H	COMPARTMENT DIMENSIONS W x D x H
1-Compartment Ultra Pan Carriers			
110V			
UPCH400	No casters	46 x 67 x 63 cm	33,5 x 53,3 x 48,6 cm
UPCHW400	With casters	46 x 67 x 79,4	33,5 x 53,3 x 48,6
220V			
UPCH4002	No casters	46 x 67 x 63	33,5 x 53,3 x 48,6
UPCHW4002	With casters	46 x 67 x 79,4	33,5 x 53,3 x 48,6
2-Compartment Ultra Camcarts			
110V			
UPCH800	Both doors heated	52 x 69 x 137,2	33 x 54,5 x 48,5
UPCHT800	Top door heated only	52 x 69 x 137,2	33 x 54,5 x 48,5
UPCH1600	Both doors heated	73 x 84,7 x 137,5	53,5 x 66,5 x 53,5
UPCH1600HD	Both doors heated, HD casters	73 x 84,7 x 138,4	53,5 x 66,5 x 53,5
UPCHT1600	Top door heated only	73 x 84,7 x 137,5	53,5 x 66,5 x 53,5
UPCHT1600HD	Top door heated only, HD casters	73 x 84,7 x 138,4	53,5 x 66,5 x 53,5
220V			
UPCH8002	Both doors heated	52 x 69 x 137,2	33 x 54,5 x 48,5
UPCHT8002	Top door heated only	52 x 69 x 137,2	33 x 54,5 x 48,5
UPCH16002	Both doors heated	73 x 84,7 x 137,5	53,5 x 66,5 x 53,5
UPCH16002HD	Both doors heated, HD casters	73 x 84,7 x 138,4	53,5 x 66,5 x 53,5
UPCHT16002	Top door heated only	73 x 84,7 x 137,5	53,5 x 66,5 x 53,5
UPCHT16002HD	Top door heated only, HD casters	73 x 84,7 x 138,4	53,5 x 66,5 x 53,5
Accessories			
CD400	Camdolly®	53 x 70 x 23	—
400STP	Strap, 5 m long	—	—

UPCH Case Pack: 1

Also Available: Top and Bottom Replacement/Retrofit Doors for 110V and 220V (non-interchangeable).

Standard Casters: 15,2 x 3,2 cm – 2 fixed, 2 swivel, 1 with brake.

Heavy Duty (HD) Casters: 15,2 x 5 cm – 2 fixed, 2 swivel with brake.

COMBO CART® PLUS (NON-ELECTRIC)



- The most versatile insulated transporter on the market! Holds food pans, sheet pans, trays and even large pizza boxes.
- Two separate compartments offer the flexibility of holding either hot or cold food.
- Tough, durable polyethylene exterior will not dent, rust or chip—a great alternative to metal holding carts!
- Thick, CFC-free polyurethane insulation throughout the cabinet ensures excellent food quality and temperature retention for 4 or more hours.
- Ideal for caterers, schools, hotels and large institutions.

Color: Charcoal Gray (615).

Note: Place food pans on rails. Pans should not be placed on the floor of the compartment. All food should be cooled to 121,11°C before placing into cart to avoid damage to the body.

Tall Combo Cart Plus Non-Electric covered by U.S. Patent D 679,468 S.



STAINLESS STEEL UNIVERSAL RAILS*
Holds sheet pans, food pans, pizza boxes and trays (or limitless combinations of these!)

*7 pairs/compartment

GASKET-FREE DOOR

Worry free door! Swings open completely to the side.

MENU POCKET

Allows for easy product ID with either an index card or by writing directly onto smooth surface with a grease pencil.

MARINE RAILING

Creates a bonus staging area for food pans.



ERGONOMIC VERTICAL MOLDED-IN HANDLES

Will never break; great for maneuvering by operators of all heights.

WIDE PADDLE LATCHES

For easy opening and closing.

PERIMETER BUMPER

Protects cart and walls.



INSULATION

CFC-free, polyurethane insulation throughout the body and doors maximizes heat or cold retention for 4 hours or more.

CASTERS**

All swivel with brakes for smooth positioning and navigation; non-marking.

**Standard or Heavy Duty (HD) casters available.



COMBO CART® PLUS (NON-ELECTRIC)



Low



Tall

CODE	CASTER TYPE	UNIT WEIGHT
Low		
CMBPL	Standard casters	52,6 kg
CMBPLHD	HD casters	56,9
Tall		
CMBP	Standard casters	95,3
CMBPHD	HD casters	99,6
Security Package		
CMBPLSP	Low, standard casters	53
CMBPLSPHD	Low, HD casters	57,3
CMBPSP	Tall, standard casters	95,7
CMBPSPHD	Tall, HD casters	100

Case Pack: 1 Color: Charcoal Gray (615).

Standard Caster: 15 x 3,2 cm
(all swivel, with brakes)

Heavy Duty Caster (HD): 15 x 5 cm
(all swivel, with brakes)

Exterior Dimensions (Low) W x D x H:
70,2 x 85,1 x 104,5 cm

Exterior Dimensions (Tall) W x D x H:
70,2 x 85,1 x 167,3 cm

Compartment Dimensions with column rails W x D x H: 53,7 x 66,7 x 64,8 cm

Security Package (SP)

Specially designed for operations where safety and security are a top priority.

- Tamper-resistant fasteners secure latches and rail columns.
- Cross-locking wires behind columns lock rails in place.
- Non-removable doors.
- Lockable hasp on each door. (padlocks not included)
- Heavy duty (HD) casters mounted with tamper resistant bolts.

Optional Accessories

CODE	DESCRIPTION
CMBPR1	1 Pair of Rails
CMBPR7	7 Pairs of Rails

Case Pack: 1 Color: (000).



Holding Capacity Reference

TYPE OF CONTAINER	STANDARD CAPACITY	RAIL SPACING	MAXIMUM CAPACITY	RAIL SPACING
45,7 x 66 CM FULL SIZE SHEET PANS	14	8,6 cm	32*	3,8 cm
33 x 5,7 CM FULL SIZE SHEET PANS	28	8,6	64*	3,8
GN 1/1 6,5 CM DEEP HOTEL PANS	28	8,6	28	8,6
GN 1/1 10 CM DEEP HOTEL PANS	20**	12,7	20	12,7
40 x 60 CM TRAYS	14	8,6	32*	3,8
32,5 x 53 CM TRAYS	28	8,6	52*	4,8
40,6 x 40,6 x 5,1 CM PIZZA BOXES	14	8,6	22	5,7

*Additional rails required. **Only requires 5 pairs of rails.

COMBO CART® PLUS (ELECTRIC)



- The most versatile insulated transporter on the market! Holds food pans, sheet pans, trays and even large pizza boxes.
- Two separate compartments offer the flexibility of holding either hot or cold food by simply keeping it unplugged.
- Tough, durable polyethylene exterior will not dent, rust or chip and remains cool to the touch during operation—a great alternative to metal holding carts!
- Thick, CFC-free polyurethane insulation throughout the cabinet ensures excellent food quality and

temperature retention for 4 hours or more, even when unplugged.

- Over 55% more energy-efficient, on average, than leading metal carts.
- Ideal for caterers, schools, hotels and large institutions.

Color: Charcoal Gray (615).

Note: Place food pans on rails. Pans should not be placed on the floor of the compartment. All food should be cooled to 121,11°C before placing into cart to avoid damage to the body.

Tall Combo Cart Plus Electric covered by U.S. Patent D 679,468 S.

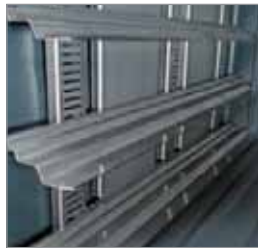

STAINLESS STEEL UNIVERSAL RAILS*
Holds sheet pans, food pans, pizza boxes and trays (or limitless combinations of these!)

*7 pairs/compartment

ENERGY-SAVING HEATER

Tall cart – over **55%** more energy efficient compared to leading metal carts, low carts – over **180%**! Gentle, non-radiant heat circulates consistently from front to back of the cabinet.

GASKET-FREE DOOR

Worry free door! Swings open completely to the side.

MARINE RAILING

Creates a bonus staging area for food pans.



ERGONOMIC VERTICAL MOLDED-IN HANDLES

Will never break; great for maneuvering by operators of all heights.

SOLAR DIGITAL THERMOMETER

Monitor internal cabinet temperature at a glance.

WIDE PADDLE LATCHES

For easy opening and closing.



PERIMETER BUMPER

Protects cart and walls.

MENU POCKET

Allows for easy product ID with either an index card or by writing directly onto smooth surface with a grease pencil.

CORD KEEPER

Stores 2,7 m power cord neatly and safely.

CASTERS**

All swivel with brakes for smooth positioning and navigation; non-marking.

**Standard or Heavy Duty (HD) casters available.



POWER ON AND HEAT ON INDICATORS

Communicate the power and heating status of the unit. Know instantly when the compartment has reached target temperature. Turn on and off without unplugging the cord.

COMBO CART® PLUS (ELECTRIC)

CODE	DESCRIPTION	UNIT WEIGHT
Low		
CMBPLH / CMBPLH2	Standard casters, 110V/220V	58,3 kg
CMBPLHHD / CMBPLH2HD	HD casters, 110V/220V	62,6
Tall		
CMBPH / CMBPH2	Standard casters, 110V/220V	105,2
CMBPHHD / CMBPH2HD	HD casters, 110V/220V	109,5
Top Door Heated Only		
CMBPTH / CMBPTH2	Top door heated only, standard casters, 110V/220V	104,6
CMBPTHHD / CMBPTH2HD	Top door heated only, HD casters, 110V/220V	108,9
Security Package		
CMBPLHSP	Low, standard casters, 110V	58,6
CMBPLHSPHD	Low, HD casters, 110V	63
CMBPHSP	Tall, standard casters, 110V	105,7
CMBPHSPHD	Tall, HD casters, 110V	110
CMBPTHSP	Top door heated only, standard casters, 110V	105
CMBPTHSPHD	Top door heated only, HD casters, 110V	109,3

Case Pack: 1 Color: Charcoal Gray (615).

Standard Caster: 15 x 3,2 cm
(all swivel, with brakes)

Heavy Duty Caster (HD): 15 x 5 cm
(all swivel, with brakes)

Exterior Dimensions (Low)
W x D x H: 70,2 x 85,1 x 104,5 cm

Exterior Dimensions (Tall)
W x D x H: 70,2 x 85,1 x 167,3 cm

Compartment Dimensions with column rails W x D x H: 53,7 x 66,7 x 64,8 cm

55% more energy efficient
than leading metal cabinets

Security Package (SP)

Specially designed for operations where safety and security are a top priority.

- Tamper-resistant fasteners secure latches and rail columns.
- Cross-locking wires behind columns lock rails in place.
- Non-removable doors.
- Lockable hasp on each door. (padlocks not included)
- Heavy duty (HD) casters mounted with tamper resistant bolts.

Optional Accessories

CODE	DESCRIPTION
CMBPR1	1 Pair of Rails
CMBPR7	7 Pairs of Rails

Case Pack: 1 Color: (000).

Electrical Specifications (Per Compartment)

	110V MODELS	220V MODELS
REQUIRED VOLTAGE	100-125 VAC	200-230 VAC
MAXIMUM AMP	4,6a	2,3a
WATTS	529w	506w
HERTZ	50/60	50/60
PHASE	Single	Single
PLUG TYPES	5-15 to C15RA	CEE7/7 to C15RA
ALTERNATE PLUG TYPES FOR INTERNATIONAL	JIS8303 to C15RA (Japan)	BS1363 to C15RA (UK / Ireland+more)
POWER CORD LENGTH	2,7 m	2,7 m

Holding Capacity Reference

TYPE OF CONTAINER	STANDARD CAPACITY	RAIL SPACING	MAXIMUM CAPACITY	RAIL SPACING
45,7 x 66 CM FULL SIZE SHEET PANS	14	8,6 cm	32*	3,8 cm
33 x 5,7 CM FULL SIZE SHEET PANS	28	8,6	64*	3,8
GN 1/1 6,5 CM DEEP HOTEL PANS	28	8,6	28	8,6
GN 1/1 10 CM DEEP HOTEL PANS	20**	12,7	20	12,7
40 x 60 CM TRAYS	14	8,6	32*	3,8
32,5 x 53 CM TRAYS	28	8,6	52*	4,8
40,6 x 40,6 x 5,1 CM PIZZA BOXES	14	8,6	22	5,7

*Additional rails required. **Only requires 5 pairs of rails.



CAMTHERM® ELECTRIC FOOD HOLDING CABINETS

Camtherm Food Holding Cabinets hold and transport hot or cold food within the kitchen, on the truck, or at the point of delivery or service. Expand your kitchen capacity, maximize productivity, and hold food

safely for hours. Enjoy the confidence of knowing moist food will stay moist and crisp food will stay crisp. Discover how one cabinet can do the work of two : with the flip of a switch, go from hot to cold or cold

to hot to increase your storage capabilities and menu flexibility. Each cabinet combines extreme durability and excellent insulated holding performance with simple, energy-efficient thermoelectric

heating and cooling with :

- **NO COMPRESSOR**
- **NO HEATING COIL**
- **NO HUMIDIFIER**



Features & benefits available in both LOW and TALL profile Camtherm carts.

Top marine rail on all units holds 2 full-size food pans, one sheet pan or one cutting board (CB1220).

Solar powered, digital display thermometer monitors internal cabinet temperature.

Self-ventilating cap on each cabinet door automatically releases steam and equalizes pressure, maintaining food quality.

Menu clip holds routing directions or list of cabinet contents.

Non-marking, high modulus, rubber casters are strong and extremely durable providing smooth transport of full cabinets from kitchen to serving location.

Cabinet exterior stays cool during operation.

Doors swing open 270° for easy loading.

Aluminum louvers gently and evenly direct hot or cold air around the entire cabinet and contents, eliminating hot or cold spots and maintaining food quality.

Knuckle door hinges are built to withstand the rigors of numerous door openings. Doors lift up and off the hinges easily for cleaning.

Easy-to-use control panel is located on back of each unit. Includes on/off switch, hot/cold switch for hot/cold units only and a temperature control dial for hot only. Cold performing units are factory set to chill cabinet down to 2,8°C.

Molded-in bumpers protect walls and furniture and will never dent, chip or rust.



Ergonomic molded-in handles are at a safe height on both low and tall profile units for easy transporting, even when fully loaded.

Heavy-duty, 14 gauge electrical cord is 274 cm long. Wrapping hook is located on back of each cabinet for safe cord storage.

Wide, nylon door latches and magnetic door gaskets lock doors securely and create a tight seal to retain safe hot or cold food temperatures.

See caster information on following page.

Cabinet exterior stays cool during operation.

Doors swing open 270° for easy loading.

Aluminum louvers gently and evenly direct hot or cold air around the entire cabinet and contents, eliminating hot or cold spots and maintaining food quality.

Knuckle door hinges are built to withstand the rigors of numerous door openings. Doors lift up and off the hinges easily for cleaning.

Easy-to-use control panel is located on back of each unit. Includes on/off switch, hot/cold switch for hot/cold units only and a temperature control dial for hot only. Cold performing units are factory set to chill cabinet down to 2,8°C.

Molded-in bumpers protect walls and furniture and will never dent, chip or rust.



Tough, one-piece, seamless double-wall polyethylene exterior is easy to clean and won't dent, crack, rust, chip or break.

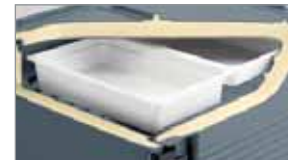

Polyurethane insulation keeps hot food hot and cold food cold during transport when unit is unplugged.

Anodized aluminum uprights and removable, adjustable chrome plated steel slide rails hold full-size food pans or sheet pans.

Energy efficient heating and/or cooling unit located on back of each cabinet. Low volt, low amp, low watt system maintains consistent hot or cold temperature and balanced humidity throughout the single cavity cabinet.

Color: Granite Grey (191), Granite Green (192), Granite Sand (194). Cutting Board Color: White (148).

Assembly is covered by U.S. Patent D 442,756 S & D 6,344,630. Venting plug is covered by US Patent D 553,717 S.

HOLDING CAPACITY LOW PROFILE

Includes 6 rail sets



Sheet Pan
11 Each 46 x 66 cm
Requires five additional rail sets.

Full-Size GN 1/1 Food Pan - 32,5 x 53 cm

- 12 GN 1/1 6,5 cm Deep
- 8 GN 1/1 10 cm Deep
- 6 GN 1/1 15 cm Deep
- 4 GN 1/1 20 cm Deep

HOLDING CAPACITY TALL PROFILE

Includes 12 rail sets



Sheet Pan
22 Each 46 x 66 cm
Requires ten additional rail sets.

Full-Size GN 1/1 Food Pan - 32,5 x 53 cm

- 24 GN 1/1 6,5 cm Deep
- 16 GN 1/1 10 cm Deep
- 12 GN 1/1 15 cm Deep
- 8 GN 1/1 20 cm Deep

CAMTHERM® ELECTRIC FOOD HOLDING CABINETS



50% more energy efficient
than leading metal cabinets

Model	Total Energy Consumption Over 8 Hours
Camtherm	2,06 kilowatt hours
Metal Cabinet	3,95 kilowatt hours

ELECTRICAL SPECS

	LOW PROFILE	TALL PROFILE
VOLTS	110V	110V
PLUG TYPE	Nema 5-15P	Nema 5-15P
MAXIMUM AMP DRAW	9,1 A	13,7 A
AMPS RUN ON	8,5 A	13,2 A
WATTS	1100	1800
HERTZ	50/60	50/60
POWER INPUT OF HEATING UNIT	120 VAC	125 VAC

Note: Only available in 110V. Contact your Cambro customer service at 800-833-3003 x 4118.

Product Specs CAD Drawings, Cut Sheets and User Manual Available at www.cambro.com.

	CODE	THERMOMETER	CASTERS	UNIT WEIGHT
LOW PROFILE	EXTERIOR dimensions: W 78 x D 107 x H 108 cm			
	Hot Only			
	CMBH1826LC	Celsius	2 front 15,2 cm swivel w/brake, 2 rear 25,4 cm rigid	75 kg
	Hot/Cold			
	CMBHC1826LC	Celsius	2 front 15,2 cm swivel w/brake, 2 rear 25,4 cm rigid	101
Correctional security package (SP) available, please contact Cambro for information				

	CODE	THERMOMETER	CASTERS	UNIT WEIGHT
TALL PROFILE	EXTERIOR dimensions: W 78 x D 107 x H 165 cm			
	Hot Only			
	CMBH1826TSC	Celsius	2 front 15,2 cm swivel w/brake, 2 rear 15,2 cm rigid	114 kg
	CMBH1826TBC	Celsius	2 front 15,2 cm swivel w/brake, 2 rear 25,4 cm rigid	116
	Hot/Cold			
	CMBHC1826TSC	Celsius	2 front 15,2 cm swivel w/brake, 2 rear 15,2 cm rigid	148
	CMBHC1826TBC	Celsius	2 front 15,2 cm swivel w/brake, 2 rear 25,4 cm rigid	150
Cabinet Colors: Granite Grey (191), Granite Green (192), Granite Sand (194).				
Correctional security package (SP) available, please contact Cambro for information				

	CODE	DESCRIPTION	DIMENSIONS H x L x W	CASE PACK
ACCESSORIES	CMBR	Set of Slide Rails	51 x 12,2 cm	1 set of 2 Rails
	CB1220	Cutting Board	53,5 x 33,5 x 1,3	1 each
Cutting Board Color: White (148).				

Time & Temperature Performance

HOT

WARM UP TIME
From ambient to hot.

RECOVERY TIME
Time to recover to hot temperature after door is held open for 30 seconds.

TRANSPORT TIME
After reaching hot temperature, amount of time unit can be held passively / unplugged until temperature reaches (65°C).

	65°C		74°C		65°C		74°C	
Low	Hot Unit	33 minutes	45 minutes	2 minutes	4 minutes	5 hours	8 hours	
	Hot/Cold Unit	33	45	2	4	5	8	
Tall	Hot Unit	30	60	1	3	4	8	
	Hot/Cold Unit	45	75	1	3	6	8	

All results based on tests with 6 full-size 15 cm deep H-Pans™ filled with 87,7°C hot water, covered and placed inside upper cabinet only.

Cold

WARM UP TIME
From ambient to cold.

RECOVERY TIME
Time to recover to cold temperature after door is held open for 30 seconds.

TRANSPORT TIME
After reaching cold temperature, amount of time unit can be held passively / unplugged until temperature reaches (65°C).

	2,8°C		2,8°C		2,8°C	
Low	Hot/Cold Unit	50 minutes	4 minutes	2 hours		
	Hot/Cold Unit	75	4	1		

All results based on tests with 6 full-size GN 1/1 15 cm deep Polycarbonate Food Pans filled with 1,1°C cold water, covered and placed inside upper cabinet only. Vent Cap Patent Pending.

INSULATED BAKERY CONTAINER – 60 X 40 CM



- Designed for the baking industry in Europe.
- Ideal for transporting products at safe cold temperatures to satellite locations.
- Perfect for baked items with cream fillings or frozen dough.
- Made with a durable polyethylene outer shell and thick polyurethane foam insulation.
- Holds sheet pans:
 - 60 x 40 cm
 - 58 x 40 cm
 - 58 x 20 cm
 - 58 x 10 cm
 or fiberglass tray: 60 x 40 cm
- Choose between wire racks with 6 rails, 10 cm apart, or 7 rails, 8,7 cm apart.

CP6040 color: Cold Blue (159).

Wire rack color: Silver (000).

Fiberglass Tray colors: Speckled Smoke (A20), Speckled Mocha (A21), Sahara (A22), Light Grey (A27), Pearl White (A33), Terrazzo (A86).

Note: Place sheet pans on rails. Pans should not be placed on the floor of a Container cavity. Please use specified sheet pan sizes.

Vent Cap Patent Pending.



Camdolly® CD300 makes it easy to transport BK60406 or BK60407.



CODE	BK60406*	BK60407*
DESCRIPTION	Container with 6 rails	Container with 7 rails
EXT. DIM.	57 x 76,5 x 82 cm	57 x 76,5 x 82 cm
INT. DIM.	42 x 63,5 x 67,5 cm	42 x 63,5 x 67,5 cm
Case Pack: 1	Color: Navy Blue (186)	* Includes 2 wireracks and 1 chiller.

Accessories

CODE	CD300	CP6040	WR60406	WR60407	GL4060**
DESCRIPTION	Camdolly	Camchiller	Wireracks w/6 rails	Wireracks w/7 rails	Market display tray
EXT. DIM.	49 x 65 x 26,5 cm	60 x 40 x 4 cm	66 x 40,5 x 5,8 cm	66 x 40,5 x 5,8 cm	60 x 40 cm
INT. DIM.	43 x 59 cm	—	—	—	—
CASE PACK	1	1	1	1	12

** Not sold in USA, Canada, Mexico, Central America and Caribbean. Vent Cap Patent Pending.

CAMCARTS® – 46 X 66 CM TRAYS, SHEET PANS AND FOOD BOXES

- Use to hold hot or cold bulk food stored on trays, sheet pans or in food boxes.
- Durable polyethylene and thick foam insulation retain safe food temperatures.
- Sturdy plastic, rust-proof latches are secured into molded-in mounting plates.
- Molded-in handle on the back for easy maneuvering.



1826DTC Double Cavity Cart for Trays and Sheet Pans

Capacity: 24 tray support rails on 4,92 cm centers (12 per cavity). Holds up to 24 each 46 x 66 cm trays or sheet/bun pans.

1826DBC Double Cavity Cart for Food Storage Boxes

Capacity: 26 support rails on 4,92 cm centers (13 per cavity). Holds 46 x 66 cm Food Storage Boxes.

Camcart with Security Package

Specially designed for high security applications, with tamper-resistant hardware: metal hinges with non-removeable pins, metal latches with welded bails, lockable hasp and chassis plate.

Colors: Slate Blue (401), Coffee Beige (157), Dark Brown (131), Charcoal Gray (615).

15,2 cm Casters: 2 fixed, 2 swivel, 1 with brake.

Note: Cool metal sheet pans to 121°C before placing onto tray supports.

Venting plug is covered by US Patent D 553,717 S.

Only 1826DBC and 1826DBCSP are NSF Listed.



CODE	DESCRIPTION	EXTERIOR DIMENSIONS W x D* x H	INTERIOR DIMENSIONS W x D x H
1826DTC	For trays & sheet pans	55 x 84,5 x 162 cm	46,4 x 67,3 x 64,6 cm
1826DBC	For food storage boxes	55 x 84,5 x 162	46,4 x 67,3 x 64,9
Camcarts with Security Packages			
1826DTCSP	For trays & sheet pans	55 x 84,5 x 162	46,4 x 67,3 x 64,6
1826DBCSP	For food storage boxes	55 x 84,5 x 162	46,4 x 67,3 x 64,9

Case Pack: 1 * Exterior Depth measurement includes handle.

CAMCARRIERS® – 32,5 X 53 CM TRAYS, SHEET PANS AND FOOD BOXES

CAMCARTS® – 46 X 66 CM TRAYS, SHEET PANS AND FOOD BOXES



1318MTC

Camcarrier for Full-size Food Pans, Trays and Half-size Sheet Pans

- Holds up to 8 each 33 x 46 cm sheet pans or 3 each full-size 10 cm deep food pans.
- Molded-in handles.
- Stackable for storage and transport.
- Fits CD300 Camdolly.



1826LBC

Camcart for Food Storage Boxes

- Holds 46 x 66 cm Food Storage Boxes.
- Capacity: 13 supports on 4,45 cm centers.
- Includes removable cutting board on top.



1826MTC

Camcarrier for Trays and Sheet Pans

- Holds up to 6 each 46 x 66 cm sheet pans.
- Six tray supports on 5,4 cm centers.
- Molded-in handles.
- Fits CD1826MTC Camdolly.



1826LTC3

Camcart for Trays and Sheet Pans

- Holds up to 7 each 46 x 66 cm trays or sheet pans.
- Seven tray supports on 9,5 cm centers for 7,62 cm clearance between trays.
- Includes removable cutting board on top.



1826LTCSP

Camcart with Security Package (SP)

- Specially designed for high security applications.
- Features tamper-resistant hardware to protect both cart and contents.
- Includes removable cutting board on top.
- Includes chassis plates with 15,2 x 3,8 cm HD Casters.



1826LTC

Camcart for Trays and Sheet Pans

- Holds up to 13 each 46 x 66 cm trays or sheet pans.
- Thirteen tray supports on 4,45 cm centers.
- Includes removable cutting board on top.

Colors: Slate Blue (401), Charcoal Gray (615), Coffee Beige (157), Dark Brown (131), Navy Blue (186). 1826MTC and 1318MTC are available in Black (110).

Strap Color: Beige (000).

Camdolly® Colors: Slate Blue (401), Coffee Beige (157), Dark Brown (131), Black (110).

CD1826MTC: 12,7 cm Casters: 2 fixed, 2 swivel, 1 with brake.

CD1826MTCCHB: 12,7 cm Casters: 2 swivel, 1 with brake and 2 25,4 cm Easy Wheels.

Standard Casters: 15,2 x 3,2 cm, 2 fixed, 2 swivel, 1 with brake.

Heavy Duty (HD) Casters: 15,2 x 5 cm, 2 fixed, 2 swivel, no brake.

Note: Cool metal sheet pans to 121°C before placing onto tray supports.

Only 1826LBC and 1826LBCSP are NSF Listed.



CODE	DESCRIPTION	EXTERIOR DIMENSIONS W x D x H	INTERIOR DIMENSIONS W x D x H
1318MTC	For trays, sheet pans & GN Food Pans	42,5 x 62 x 57 cm	33,3 x 54 x 36 cm
1826MTC	For trays & sheet pans	55 x 74,5 x 57	46,7 x 66,4 x 35,9
Camdolly			
CD300	Camdolly for 1318MTC	53 x 70 x 23	46 x 63,5
CD1826MTC	Camdolly for 1826MTC	61 x 89 x 91	55,9 x 72,4
CD1826MTCCHB	Camdolly with Easy Wheels for 1826MTC	70 x 89 x 93,5	55,6 x 72,5
Camcarts			
1826LTC	For trays & sheet pans	55 x 81,5 x 95,5	46 x 66,4 x 65,7
1826LTC3	For trays & sheet pans	55 x 81,5 x 95,5	46 x 66,4 x 65,7
1826LBC	For food storage boxes	55 x 81,5 x 95,5	46 x 66,4 x 65,7
Camcarts with Security Package** (Includes Chassis Plat, 15,2 x 5 cm HD casters)			
1826LTCSP	For trays & sheet pans	55 x 81,5 x 95,5	46 x 66,4 x 65,7
1826LBCSP	For food storage boxes	55 x 81,5 x 95,5	46 x 66,4 x 65,7
Securing Strap			
1826STP	Securing strap	—	—

Case Pack: 1 Venting plug is covered by U.S. Patent D 553,7175 S * With handle.

TABLOTERM INSULATED TRAYS

Only available from Cambro European Logistics (CEL), Germany.

SPECIFICATIONS

Material	Polypropylene + foam insulation
Characteristic	Insulated tray
Performance	Excellent
Heat Retention	Approximately 60 minutes*
Dishwasher Safe	Yes
Stackable	Yes
Minimum Food & Plate Temperature before Plating	85° – 90°C
Individual Dish Cover	Yes – prevent spilling of soup and sauces



* With heated pellet. Not for use in heated carts.

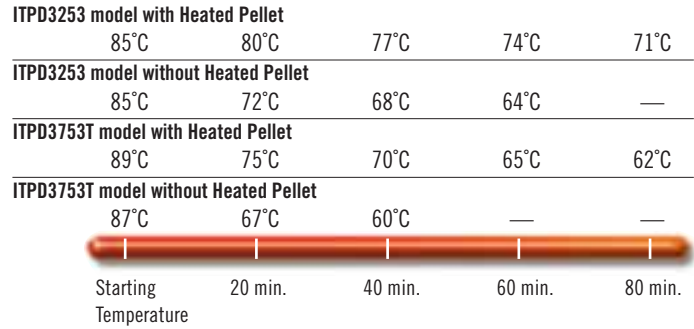

RECOMMENDED USE

- Moderate Use
- Hospital Meal Delivery / Nursing Homes
 - Hotel Room Service
 - Catering
 - Home Meal Delivery



ITPD3253 – Gastronorm size



ITPD3753T – Euronorm size



Light gray polypropylene lid with integrated rubber seal. Lid cannot be used in microwave oven.

For a complete guide to maximizing heat retention, contact your Cambro representative.

CODE	DESCRIPTION	DIMENSIONS W x L x H
Tablotherm – Insulated Tray with Porcelain Dishes, seal covers and pellet		
ITPD3753T	Euronorm insulated tray including: 1 ea. two-compartment plate (122 400 050), 1 ea. reusable cover (122 600 050), 1 ea. pellet (165PW), 3 ea. multi-purpose bowls: 2 ea. 400 mL (122 500 050), 1 ea. 500 mL (122 450 050) and 3 ea. reusable covers: 2 ea. (122 700 050) and 1 ea. (122 650 050)	37 x 53 x 10,5 cm
ITPD3253	Gastronorm insulated tray including: 1 ea. two-compartment plate (122 400 050), 1 ea. reusable cover (122 600 050), 1 ea. pellet (165PW) 2 ea. multi-purpose bowl (122 500 050) and 2 ea. reusable cover (122 700 050)	32,5 x 48 x 10,5
Tablotherm – Insulated Tray without porcelain dishes, seal covers and pellet		
IT3753T	Euronorm insulated tray – Empty	37 x 53 x 10,5
IT3253	Gastronorm insulated tray – Empty	32,5 x 48 x 10,5
Porcelain dishes		
122 400 050	Two compartment plate. Outside ø 254 mm Capacity 750 mL (White)	
122 450 050	Multi-purpose bowl. Outside ø 142,2 mm Capacity 500 mL (White)	
122 500 050	Multi-purpose bowl. Outside ø 120 mm Capacity 400 mL (White)	
Reusable polypropylene covers, light gray with integrated rubber seal		
122 600 050	For two compartment plate	
122 650 050	For multi-purpose bowl – 500 mL	
122 700 050	For multi-purpose bowl – 400 mL	
Pellet System		
165PW	SMC pellet ø 16,5 cm	
Menu card		
112 430 000	Yellow menu cards 100 x 70 mm	
Latches		
122 201 050	Latches with menu card holder (IT3253, ITPD3253)	
122 200 050	Latches without menu card holder (IT3253, ITPD3253)	
122 260 050	Latches and screw kit: 1 ea. latch, 4 ea. screws (IT3753T, ITPD3753T)	
ITPD3753T, IT3753T Color: Gray and Blue. ITPD3253, IT3253 Color: Two Tone Gray. 165PW Color: A42 165PW Case Pack: 1 Each.		



MERCHANDISING EQUIPMENT

Versa Food Service System

Versa Food Bar® and Versa Work Table Ultra Series

Food Bar Accessories

Table Top Food Bars, Buffet Bars & Sneeze Guards

Sample Food Bar Set-ups

CamKiosk® System

Hand Sink Cart

Camcruiser® Vending Carts

Booster Seats & Versa Organizers

Portable CamBars®

SlidingLid™ Ice Caddies



VERSA FOOD SERVICE SYSTEM



The Versa Food Service System provides custom design without the custom price. This non electric, versatile, portable system keeps food cold for hours with either ColdFest® pans or Buffet Camchillers®. The system is made of durable all-weather material and is easy to clean. The Versa Food Service System offers countless configurations to fit any foodservice need.

- Ergonomic, molded-in handles on both sides ensure easy maneuvering.
- Versa Food Bar and Work Table both include a drain faucet that can be connected to a hose for drainage and easy cleaning.
- Add an end table to a Food Bar or Work Table to hold trays, condiments, or paper goods.

Versa Cart

- Join a Versa Cart with a Food Bar or Work Table for fast check-out and improved traffic flow.
- The Versa Cart includes an adjustable shelf, standard lockable drawer and convenient electrical access through the top of the cart and front design panel.
- Optional Tray rails easily adjust to a lower height.
- Optional pull-out keyboard tray fits inside the drawer.



All components are fully compliant with NSF requirements.

Versa Food Service System is covered under U.S. Patent 9,084,498 B2.

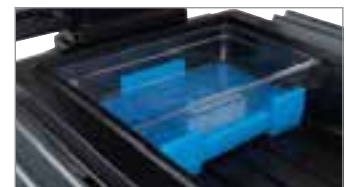

Versa Straight Connector and Versa Corner Connector

Easily and safely attach multiple components together to create a contiguous system and maximize space and merchandising options.

Versa Food Bar® Lighting Kit

Enhance your foodservice presentation with the LED lighting accessory. The light uses a 12 volt long-lasting battery, that charges with an universal charger.

Buffet Camchillers®

Extend safe, cold holding time without ice. Dual-sided Buffet Camchillers hold 6,5 and 10 cm pans. Fits in the Versa Food Bar, Versa Work Table and Table Top Food Bars.

VERSA FOOD SERVICE SYSTEM

Whether you're looking to maximize space, improve traffic flow, add merchandising space or create an upscale salad bar, the Versa Food Service System has you covered.



Versa Food Bar



All components are fully compliant with NSF requirements.



Versa Work Table

- Perfect for a prep table, display, self-serve station or back bar.
- Attach a Work Table to a Food Bar to merchandise snacks and beverages.
- Matching well covers are included with each Versa Work Table.



Standard height model.

VERSA BAR AND VERSA WORK TABLE – ULTRA SERIES

- Now available with two secure storage cabinets that can hold up to 22,7 kg per compartment of non-perishable items.



Storage Dimensions:
L 54,61 x W 44,45 x H 45,72 cm per cabinet.
Each cabinet is 0,11 M³.



All components are fully compliant with NSF requirements.

VERSA FOOD SERVICE SYSTEM

CODE	DESCRIPTION	OVERALL EXTERIOR DIMENSIONS L x W x H	FULL PAN SIZE CAPACITY	WELL INTERIOR DIMENSIONS L x W x H
Versa Food Bars® – Standard Height				
VBR5	152 cm with standard casters	175,3 x 108 x 159,4 cm	4	132,8 x 53,3 x 18 cm
VBRHD5	152 cm with heavy duty casters	175,3 x 108 x 159,4	4	132,8 x 53,3 x 18
VBR6	183 cm with standard casters	208,3 x 108 x 159,4	5	165,4 x 53,3 x 18
VBRHD6	183 cm with heavy duty casters	208,3 x 108 x 159,4	5	165,4 x 53,3 x 18
Versa Food Bars® Ultra Series – Standard Height				
VBRU5	152 cm with standard casters and storage	175,3 x 108 x 159,4	4	132,8 x 53,3 x 18
VBRUHD5	152 cm with heavy duty casters and storage	175,3 x 108 x 159,4	4	132,8 x 53,3 x 18
VBRU6	183 cm with standard casters and storage	208,3 x 108 x 159,4	5	165,4 x 53,3 x 18
VBRUHD6	183 cm with heavy duty casters and storage	208,3 x 108 x 159,4	5	165,4 x 53,3 x 18
Versa Food Bars – Low Height				
VBRL5	152 cm with standard casters	175,3 x 108 x 141,6	4	132,8 x 53,3 x 18
VBRLHD5	152 cm with heavy duty casters	175,3 x 108 x 141,6	4	132,8 x 53,3 x 18
VBRL6	183 cm with standard casters	208,3 x 108 x 141,6	5	165,4 x 53,3 x 18
VBRLHD6	183 cm with heavy duty casters	208,3 x 108 x 141,6	5	165,4 x 53,3 x 18
Versa Work Tables – Standard Height				
VBRT5	152 cm with standard casters	175,3 x 68,6 x 99,06	4	132,8 x 53,3 x 18
VBRTHD5	152 cm with heavy duty casters	175,3 x 68,6 x 99,06	4	132,8 x 53,3 x 18
VBRT6	183 cm with standard casters	208,3 x 68,6 x 99,06	5	165,4 x 53,3 x 18
VBRTHD6	183 cm with heavy duty casters	208,3 x 68,6 x 99,06	5	165,4 x 53,3 x 18
Versa Work Tables Ultra Series – Standard Height				
VBRUT5	152 cm with standard casters and storage	175,3 x 68,6 x 99,06	4	132,8 x 53,3 x 18
VBRUTHD5	152 cm with heavy duty casters and storage	175,3 x 68,6 x 99,06	4	132,8 x 53,3 x 18
VBRUT6	183 cm with standard casters and storage	208,3 x 68,6 x 99,06	5	165,4 x 53,3 x 18
VBRUTHD6	183 cm with heavy duty casters and storage	208,3 x 68,6 x 99,06	5	165,4 x 53,3 x 18
Versa Work Tables – Low Height				
VBRTL5	152 cm with standard casters	175,3 x 68,6 x 74,3	4	132,8 x 53,3 x 18
VBRTLHD5	152 cm with heavy duty casters	175,3 x 68,6 x 74,3	4	132,8 x 53,3 x 18
VBRTL6	183 cm with standard casters	208,3 x 68,6 x 74,3	5	165,4 x 53,3 x 18
VBRTLHD6	183 cm with heavy duty casters	208,3 x 68,6 x 74,3	5	165,4 x 53,3 x 18

Case Pack: 1

CODE	DESCRIPTION	OVERALL EXTERIOR DIMENSIONS L x W x H
Versa Cart		
VCSWR	With dual tray rails and standard casters	134 x 81,9 x 109,2 cm (with tray rails up)
VCSWRHD	With dual tray rails and heavy duty casters	134 x 81,9 x 109,2 (with tray rails up)
VCS	With standard casters and no tray rails	81,3 x 81,9 x 109,2
VCSHD	With heavy duty casters and no tray rails	81,3 x 81,9 x 109,2
Connectors		
VBRC	Straight connector - food bar to food bar	68,6 x 48,3 x 10,8
VBRC90	Corner connector - food bar to food bar	91,4 x 91,4 x 10,8
VCS32CNT	Straight connector - cart to standard height food bar / work table	68,6 x 51,75 x 8,26
VCSCNL	Straight connector - cart to low height food bar / work table	68,6 x 51,75 x 21,59

Case Pack: 1 **Versa Food Bar, Versa Work Table, Versa Cart, Connectors, Well Cover Colors:** Black (110), * Hot Red (158), * Navy Blue (186), * Kentucky Green (519).

Tray Rail and End Table Colors Only: Granite Gray (191), ** Black (110).

* Made to order colors for Versa Food Bar, Versa Work Table, Versa Cart, Connectors, Well Cover, Tray Rail and End Table.

** Made to order color for Tray Rail and End Table only. Made to order items not carried in stock, non-returnable.

FOOD BAR ACCESSORIES

Every Accessory You Need

- Crock and Salad Bowl Holders highlight and organize salads, condiments and dressings.
- Tray Rails offer convenience for your patrons.

See Polycarbonate Food Pans and Crocks section for more information.

Versa Cart with Dual Tray Rails (VCSWR & VCSWRHD): All orders receive the tray rails in Granite Gray (191). To choose a different color tray rail you must order the Versa Cart Without Rails (VCS or VCSHD) and the tray rails (VCS32R) separately.

Connector Colors: Black (110), Hot Red (158), Navy Blue (186), Kentucky Green (519).

Vinyl Cover Color: Opaque (000).

Sign Holder Color: Clear (152).

Buffet Camchiller® Color: Cold Blue (159).

Divider Bar Colors: White (148), Clear (152).

Well Cover Colors: Black (110), Hot Red (158), Navy Blue (186), Kentucky Green (519).

Keyboard Tray Color: Black (110).

Crock, Salad Bowl Holders Colors: White (148), Granite Gray (191).

Versa Food Bar is covered under U.S. Patent D 615,323 S and D 620,730. Versa Food Bar Ultra Series is covered under U.S. Patent D702,066 S. Versa Cart is covered under U.S. Patent D 653,830 S. Buffet Camchiller is covered under U.S. Patent D 618,4765 S. All other parts patent pending.

* Items are not NSF Listed.

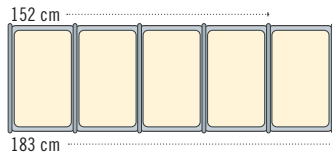

- 183 cm models hold 5 full size Pans with Divider Bars.
- 152 cm models hold 4 full size Pans with Divider Bars.

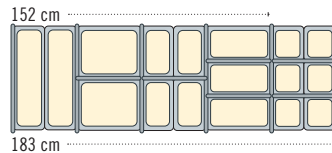

- Fractional Size Pans can be used in many variations with Divider Bars. Mix and match sizes to fit your needs.

Two Salad Bowl Holder models available, SBH18 and SBH15. Crock Holder, CPH3, holds 1,4 and 2,6 L crocks.

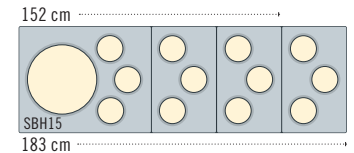
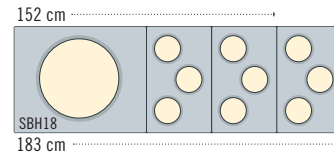

- 183 cm models hold a Salad Bowl Holder and 3 ea. Crock Holders.
- 152 cm models hold a Salad Bowl Holder and 2 ea. Crock Holders.

CODE	DESCRIPTION	OVERALL EXTERIOR DIMENSIONS L x W x H	CASE PACK
VBRR5	Tray rail for 152 cm - Versa Food Bar / Versa Work Table	134,6 x 29,2 x 11,6 cm	1
VBRR6	Tray rail for 183 cm - Versa Food Bar / Versa Work Table	167,6 x 29,2 x 11,6	1
VCS32R	Tray rail for - Versa Cart	71,12 x 29,7 x 12,7	1
VBRTBL	End table for Versa Food Bar and Work Table	68,6 x 55,88 x 11,43	1
LED54LIGHTPKG*	Led light strip 137 cm long with brackets, battery and wall charger	137	1
VBRCVR5*	Vinyl cover for 152 cm Versa Food Bar	185,4 x 110,5 x 116,8	1
VBRCVR6*	Vinyl cover for 183 cm Versa Food Bar	210,8 x 110,5 x 116,8	1
VBRTCVR5*	Vinyl cover for 152 cm Versa Work Table	177,8 x 85,1 x 53,3	1
VBRTCVR6*	Vinyl cover for 183 cm Versa Work Table	210,8 x 85,1 x 53,3	1
VCSCVR*	Vinyl cover for Versa Cart	106,7 x 83,8 x 91,4	1
VBRSHTS*	Versa Food Bar sign holder	91,4 x 15,2 x 23,5	1
DIV12	30,5 cm divider bars	32,39	3
DIV20	51 cm divider bars	53,02	3
CPH3	Crock holder holds 1,4 & 2,6 l	L 33 x W 53	1
SBH15	Salad bowl holder holds a 38,1 cm bowl and 3 crocks	L 65,5 x W 53	1
SBH18	Salad bowl holder holds an 45,7 cm bowl	L 65,5 x W 53	1
CPB1220	Buffet camchiller for versa food bars, work tables and table top food bars	46,99 x 32,07 x 10,16	1
VBRWC	Versa well cover for Versa Food Bar/Work Table	53,02 x 33,02 x 5,08	1
VCS32KEYT	Versa Cart keyboard tray	52,4 x 25,71 x 5,08	1

Versa Food Bar includes Versa Food Bar with and without cabinet.

TABLE TOP FOOD BARS, BUFFET BARS & SNEEZE GUARDS



Table Top Food Bars

- Turn a 122-183 cm table into a double-sided self service buffet or beverage station.
- Thick, foam-insulated well keeps food cold for hours with Buffet Camchillers or ice.
- Drain plug allows for quick and easy clean-up.



4FBRTT Table Top Food Bar
Buffet Camchiller® available.

Buffet Bars

- Ideal for holding snacks and cold beverages.
- The Buffet Bar with Sneeze Guard is perfect for single-sided, self-serve buffets.

Food Bar Colors: Black (110), Navy Blue (186), Kentucky Green (519), Hot Red (158).

Crock Holder and Salad Bowl Holders available in White (148), Granite Gray (191), Sandstone (614).

BUF48 and BUF72 are NSF listed.

* NSF listed for non-direct food contact only.



FSG480 Sneeze Guard
The Free Standing Sneeze Guard is the perfect showcase for salad or dessert items.



BUF48 Buffet Bar Base
Merchandises soft drinks on ice to increase beverage sales.



BBR480 Buffet Bar with Sneeze Guard

CODE	OVERALL EXTERIOR DIMENSIONS	FULL SIZE PAN CAPACITY	WELL INTERIOR DIMENSIONS
Table Top Food Bars			
	L x W x H		L x W x D
6FBRTT	181,6 x 84,5 x 68,6 cm	5	159,7 x 51,1 x 16,5 cm
5FBRTT	161,3 x 84,5 x 68,6	4	127,2 x 51,1 x 16,5
4FBRTT	129,5 x 84,5 x 68,6	3	94,6 x 51,1 x 16,5
Buffet Bars			
	L x W x H		L x W x D
BUF72	171,5 x 61 x 17,8	5	159,7 x 51,1 x 12,7
BUF48	106,2 x 61 x 17,8	3	94,6 x 51,1 x 12,7
Free Standing Sneeze Guards			
	L x W x H		L x W
FSG720	187,6 x 41,9 x 62,2	—	171,5 x 38,7
FSG480	121,9 x 41,9 x 62,2	—	106,7 x 38,7
Buffet Bars w/Sneeze Guard			
	L x W x H		L x W x D
BBR720	187,6 x 61,3 x 62,2	5	159,7 x 51,1 x 12,7
BBR480	121,9 x 61,3 x 62,2	3	94,8 x 51,1 x 12,7

Case Pack: 1

SAMPLE FOOD BAR SET-UPS

Visit www.cambro.com/schools for food bar resources, best practices and free posters.



152 cm model



183 cm model



Fresh Food Bars Pre-packaged Breakfast



Rainbow Theme

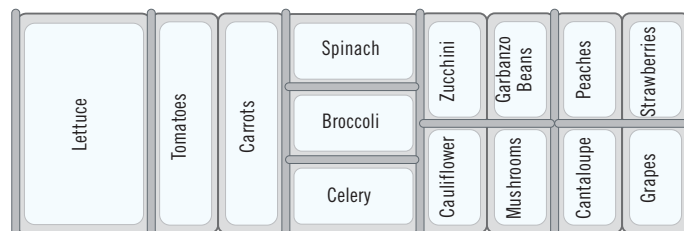

Fresh Food Bars Pre-packaged Lunch



Taco Theme

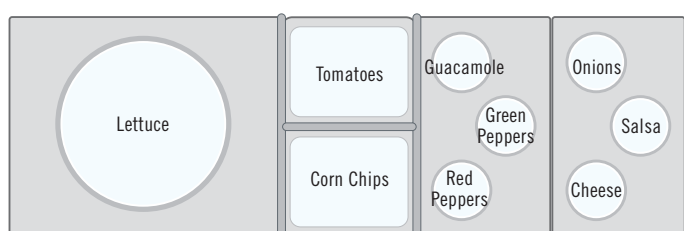

Chili Theme



Burger Theme

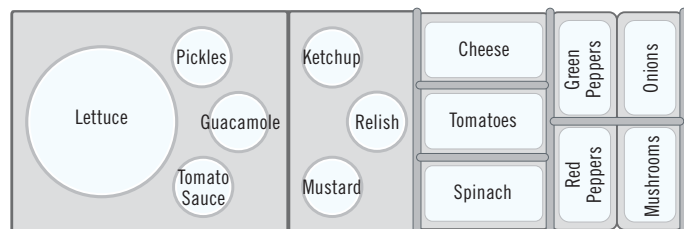

CAMKIOSK® SYSTEM – EVERY EVENT OR LOCATION IS AN OPPORTUNITY FOR PROFITS



- Build sales off premise and in non-traditional locations.
- Two insulated food storage cabinets maintain safe hot or cold food and/or beverage temperatures for hours.
- Use optional well covers to cover food pan wells and increase countertop space.
- Durable, all-weather polyethylene exterior with foam insulation will not crack, dent, bubble, chip, rust or break.
- Heavy duty 15,2 cm casters roll smoothly from kitchen to location then lock in place.

CAMKIOSK® CARTS



Telescoping poles enable canopy to lower 30,5 cm for quick and easy storage.



KVC854C Cart with 4 pan wells & canopy.

Cart Colors



Navy Blue



Hot Red

Canopy Color



Beige

Cart Colors



Granite Grey

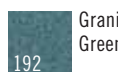

Granite Green



Kentucky Green



Black Base with Granite Grey Top & Doors

Canopy Colors



Kentucky Green

Personalize your CamKiosk Cart to promote your brand.

CANOPY TRIM AND TOP PANEL

(Charges per side)

One Color **

Two Color **

Three Color **

FRONT DISPLAY PANEL

(Cruising Café® panel standard)

Set Up Charge per Panel **

Charge per Color **

** Contact your Cambro representative for pricing.



Conveniently located, lockable cash box (included) can also be kept in dry storage compartment.



Camchillers® keep cold packaged foods cold during transport and service when placed directly on top of food pan wells or at the top of the CamKiosk's insulated holding cabinet.



4 well top

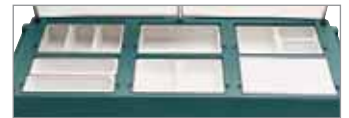

6 well top

CODE	FULL SIZE PAN WELLS	OVERALL DIMENSIONS L x W x H
CamKiosk Carts		
KVC854	4	216 x 85 x 179 cm
KVC854C	4	216 x 85 x 239
KVC856	6	216 x 85 x 179
KVC856C	6	216 x 85 x 239

C: Canopy

Holding Capacity Per Compartment

Two holding cabinets store hot or cold food in Gastronorm Food Pans with Covers.

12 GN 1/1 full size 6,5 cm deep pans or
8 GN 1/1 full size 10 cm deep pans or
6 GN 1/1 full size 15 cm deep pans or
4 GN 1/1 full size 20 cm deep pans.
4 each 2025 Camtrays or
8 each 3253 Camtrays.

Well Cover Colors: Black (110), Hot Red (158), Navy Blue (186), Kentucky Green (519), Granite Grey (191), Granite Green (192).

15,24 cm Casters: 2 fixed, 2 swivel, 2 with brake.

Cutting Board Color: White (148).

Camchiller Color: Cold Blue (159).

ThermoBarrier Color: Slate Blue (401).



Camchiller & ThermoBarrier

CODE	DESCRIPTION	DIMENSIONS L x W x H	CASE PACK
Optional Accessories			
CB1220	Cutting board	53,5 x 33,5 x 1,3 cm	1
CP814	20,32 x 35,56 cm Camchiller®	3,81 x 20,32 x 35,56	1
CP1220	Camchiller	53 x 33 x 3,8	1
WCR1220	Well cover	53,5 x 33 x 5	1
1600DIV	ThermoBarrier® insulated shelf	53 x 33,5 x 3,8	2

C: Canopy

CAMKIOSK® HAND SINK CART, WORK STATION & EQUIPMENT STAND

Hand Sink Cart

- Self-contained, electric hand washing system can be used alone or with CamKiosk Cart.
- Run hot and cold water for up to 70 hand washings.
- Includes: double sink, two 19 L fresh water tanks, two 28,5 L waste-water bins, hand soap dispenser and paper towel roll holder.
- Durable polyethylene will not crack, dent, bubble, chip or break.
- Hand Sink Cart is designed for hand washing. It contains no filter for purifying water for drinking.
- Faucet is compliant with lead-free regulations.

Colors: Granite Grey (191), Granite Green (192), Navy Blue (186), Hot Red (158), Kentucky Green (519), Black Base with Granite Grey Top & Doors (426).

15,2 cm Casters: 2 fixed, 2 swivel, 2 with brake.

Hand Sink Cart is covered by U.S. Patent 6,173,458 B1.



Water heater and water pump draw a maximum of 11,25 amps and 0,7 amps, respectively. Hand Sink Cart electrical system runs on an average 10 amps.

ADA faucet available. Contact Cambro Customer Service for information.



Hand Sink Cart is designed for hand washing. It contains no filter for purifying water for drinking.

CODE	VOLTAGE	DIMENSIONS L x W x H
KSC402	110	103 x 84 x 116 cm

Case Pack: 1

Work Station

- Use to merchandise menu items, additional work space or to complete sales transactions.
- Large dry storage cabinet below is perfect for holding supplies.
- Extremely durable all-weather polyethylene will not crack, dent, bubble, chip, rust or break.

Colors: Granite Grey (191), Granite Green (192), Navy Blue (186), Hot Red (158), Kentucky Green (519), Black Base with Granite Grey Top & Doors (426).

15,2 cm Casters: 2 fixed, 2 swivel, 2 with brake.

Top Work Area Dimensions: 57,2 x 66 cm



Shown with optional cutting board and paper towel roll dispenser.

CODE	DESCRIPTION	DIMENSIONS L x W x H
KWS40	Work station	103 x 84 x 116 cm
CB1220	Cutting board	53,5 x 33,5 x 1,3

Case Pack: 1

Equipment Stand

- Perfect for self-serve stations, prep areas or cash register service.
- Counter and side openings for electrical cords and cables.
- Durable, lightweight polyethylene will not crack, dent, bubble, chip, rust or break.
- No assembly required.

Color: Black (110).

12,7 Casters: 2 fixed, 2 swivel with brake.

* Special order item not carried in stock – non-returnable.







Cutaway chair area gives ample space for comfortable seating.

CODE	DESCRIPTION	OVERALL DIM. W x D x H**
ES28	Stand only	71 x 71 x 99 cm
ES28RL*	Stand w/rails on right and left sides of drawer	112 x 71 x 99

** Width includes tray rails. Height includes casters.

CAMCRUISER® VENDING CARTS

- Add revenue opportunities away from the kitchen or cafeteria and reduce wait times.
- Durable polyethylene will not crack, dent, bubble, chip, rust or break.
- Display panel can be personalized with a custom logo or message.
- Larger models CVC724 & CVC72 have insulated food storage compartments and full-size food pan wells.
- The compact CVC55 has two open storage compartments, a single food pan well and cutting board.

Cart Color	Umbrella Color
Black (110)	
Hot Red (158)	
Kentucky Green (519)	
Granite Gray (191)	
Granite Green (192)	



CVC724

OPEN COMPARTMENT DIMENSIONS:
W 33,5 x D 61,5 x H 34 cm

CVC72 & CVC724



CVC72

CVC724 Four full size food pan wells. Replace with cutting boards or well covers to create additional work space.



CVC72 One full size food pan well and 2 larger merchandising wells.



Open holding compartment conveniently stores cash box and tray.

CODE	CVC724	CVC72	CVC55
OVERALL DIMENSION*	L 189 x W 81 x H 239 cm	L 189 x W 81 x H 239 cm	L 140 x W 80 x H 238 cm
WORK COUNTER HEIGHT	93 cm	93 cm	101 cm
COUNTER WELLS HOLD	4 GN 1/1	Center well, 1 GN 1/1 2 outer wells, L 56 x W 39 x D 15 cm	1 GN 1/1
CLOSED COMPARTMENT CAPACITY (EACH)	2 GN 1/1-20 cm + 2 GN 1/1-6,5 cm deep pans or 4 GN 1/1-15 cm deep pans or 6 GN 1/1-10 cm deep pans or 8 GN 1/1-6,5 cm deep pans or 4 each 2025 Camtrays or 8 each 3253 Camtrays	2 full size 20 cm + 2 GN 1/1-6,5 cm deep pans or 4 GN 1/1-15 cm deep pans or 6 GN 1/1-10 cm deep pans or 8 GN 1/1-6,5 cm deep pans or 4 each 2025 Camtrays or 8 each 3253 Camtrays	—
OPEN COMPARTMENT CAPACITY	1 cash drawer and 1 GN 1/1-15 cm deep pan or 2 GN 1/1-10 cm deep pans or 3 GN 1/1-6,5 cm deep pans	1 cash drawer and 1 GN 1/1-15 cm deep pan or 2 GN 1/1-10 cm deep pans or 3 GN 1/1-6,5 cm deep pans	—
UMBRELLA DIAMETER	183 cm	183 cm	152 cm
CASTERS	20,3 cm - 4 swivel with brake	20,3 cm - 4 swivel with brake	15,2 cm - 2 fixed, 2 swivel with brake
CASH DRAWER	Yes	Yes	—
MENU BOARD	Yes	Yes	—
DISPLAY PANEL	Yes	Yes	Yes
MOLDED IN HANDLES	2	2	1

* Includes Umbrella. Serving counter height is 130 cm.



CVC55

Unit ships with umbrella and cutting board. Front display panel can be personalized.

- Cutting Board Color:** White (148).
 - Camchiller Color:** Cold Blue (159).
 - Divider Bar Colors:** White (148), Clear (135).
 - Retainer Strap Color:** Black (110).
 - ThermoBarrier® Color:** Slate Blue (401).
- Well Cover Color matches cart.

CVC55 is covered by U.S. Patent D 362,102.



Camchiller, ThermoBarrier, and Divider Bar.



Compartments are open for storage and easy access to equipment and supplies for your vending operations. Optional retainer strap is sold separately.

LEFT COMPARTMENT DIMENSIONS:
W 61,5 x D 72,5 x H 70 cm

RIGHT COMPARTMENT DIMENSIONS:
W 54,5 x D 72,5 x H 70 cm



Pizza Camcruiser



Sandwich Camcruiser



Hot Dog Camcruiser



Soft Drink Camcruiser

Display Panel Personalization

Provide complete, finished, camera-ready artwork and indicate positioning on display panel.

Ink colors must be specified. Choose 1-4 colors.

Size of imprinting area:

CVC72 and CVC724
W 53,5 x H 74,5 cm
CVC55 W 112,5 x H 74,5 cm

Artist's fee of ** net/hour will be charged to any order submitted without camera-ready artwork.

Cambro will contact you prior to completing any work if this fee will be charged.

Set up charge of ** net per design, plus ** net per color.

Allow for three week production lead time once final proofs are approved.

* CVC72 and CVC724 - Campus Cuisine display panel standard with all orders unless custom personalization requested.

** Contact your Cambro representative for pricing.

CVC55



Set up with full and fractional size food pans and divider bars to increase product offerings.



Electrical or soda line conveniently drops through 10 x 17 cm opening in counter. Cover is standard with cart.

CODE	DESCRIPTION	FITS	OVERALL DIM. L x W x H
Optional Accessories			
CB1220	Cutting board	CVC724, CVC72, CVC55	53,5 x 33,5 x 1,3 cm
CP1220	Camchiller®	CVC724, CVC72	53 x 33 x 3,8
DIV12	Divider bar	CVC724, CVC72, CVC55	32,5 long
WCR1220	Well cover	CVC724, CVC72, CVC55	53,5 x 33 x 5
730STP	Retainer strap	CVC55	—

DIV12 Case Pack: 3 - 1200DIV Case Pack: 2 - All Others Case Pack: 1
Camchiller, ThermoBarrier & Divider Bar are NSF listed.

BOOSTER SEATS & VERSA ORGANIZERS

Booster Seats

- Contoured seat, high sides, wide square base and non-skid surface for toddler comfort and safety.
- Choose from dual or single seat models, with or without strap.
- Durable polyethylene will not crack, dent, bubble, chip, rust or break.

Colors: Black (110), Dark Brown (131), Coffee Beige (157), Navy Blue (186), Kentucky Green (519), Hot Red (158).
 No broken cartons on 4 pack.



A Single Seat

B Dual Seat

DIMENSIONS	W x D x H
Overall	29,5 x 28,6 x 20,6 cm
Seat Base	22,2 x 24,7
Inside Seat	24,1 x 24,7 x 10,2

CODE	100BC	100BC1	100BCS
Single Seat			
DESCRIPTION	no strap	no strap	with strap
CASE PACK	4	1	4



Booster seats are available with or without straps.

DIMENSIONS	W x D x H
Overall	31,6 x 31,1 x 23,8 cm
Seat Base A	31,6 x 31,1
Seat Base B	32,1 x 30,8
Inside Seat A	21 x 24,4 x 8,3
Inside Seat B	27,3 x 27,3 x 12,1

CODE	200BC	200BC1	200BCS
Double Seat			
DESCRIPTION	no strap	no strap	with strap
CASE PACK	4	1	4

Versa Organizers

- Use to store non-perishable condiments, disposable ware and napkins.
- Hold bins in 2 x 3, 2 x 4, 3 x 3, or 3 x 4 arrangements.
- Made of seamless, one-piece polyethylene.
- Set on flat surface or wall mount each bin holds up to 4,5 kg.
- Easy to assemble and easy to clean.

Bins Only Colors: Coffee Beige (157), Dark Brown (131), Black (110), Slate Blue (401), Speckled Grey (480).
 Versa Line Combined Pack Bins & Racks.
Colors: Dark Brown (131), Black (110), Speckled Grey (480).



12RS12 Versa Organizer shown mounted on wall.



Bins sold separately (5412CBP) or as combined packs.



8RS8



6RS6

CODE	DESCRIPTION	PRODUCT DIMENSIONS	CASE PACK
Bins		W x D x H	
5412CBP		13 x 30,5 x 11 cm	12
Versa Line Combined Pack		L x D x H (complete unit)	
12RS12	Rack w/12 bins	64,8 x 54,3 x 36,2	1
9RS9	Rack w/9 bins	51,1 x 54,3 x 36,2	1
8RS8	Rack w/8 bins	64,8 x 48,8 x 24,1	1
6RS6	Rack w/6 bins	51,1 x 48,8 x 24,1	1



PORTABLE CAMBARS®

- Stylish, portable beverage bars for hosting in any environment.
- Select from three systems: economy for bottle and can service, partial or complete soda gun set up systems for pre-mix (canisters) or post-mix (bag-in-box).
- Available in three sizes:
 - Large BAR730 is perfect for banquets and cocktail events.
 - Mid-size BAR650 fits into standard elevators and is ideal for small to mid-size functions.
 - Small BAR540 is ultra portable for off-premise use and events with limited space.
- All models include speed rail and 36,3 kg capacity ice sink with cover. BAR540 sink comes uncovered.
- Impact-resistant, waterproof polyethylene will not crack, dent, bubble, chip, rust or break.
- Lightweight and portable.
- Easy to take apart and clean, easy to set up.



BAR650 Shown in Standard Decor Granite Sand (194).



BAR650DS Shown in Designer Decor Sedona (668).

THREE SIZES

THREE SYSTEMS

ECONOMY SYSTEM

- For Bottle, Can, or Mixer Service.
- Includes Ice Bin & Speed Rail.
- Standard or Designer Decor.

BASIC SYSTEM

- Partially Equipped for Post or Pre-Mix Soda Service.
- Operator Completes Installation.
- Standard or Designer Decor.

COMPLETE SYSTEM

- Completely Factory Equipped for Post or Pre-Mix Soda Service.
- Standard or Designer Decor.

Large BAR730 Models



Standard Decor
BAR730

Designer Decor
BAR730DS

Standard Decor
BAR730CP

Designer Decor
BAR730DSCP

Standard Decor
BAR730PM, BAR730PMT,
BAR730PMT220, BAR730DX

Designer Decor
BAR730DSPM, BAR730DSPMT,
BAR730DSPMT2, BAR730DSDX

Mid-Size BAR650 Models



Standard Decor
BAR650

Designer Decor
BAR650DS

Standard Decor
BAR650CP

Designer Decor
BAR650DSCP

Standard Decor
BAR650PM, BAR650PMT,
BAR650PMT220, BAR650DX

Designer Decor
BAR650DSPM, BAR650DSPMT,
BAR650DSPMT2, BAR650DSDX

Small BAR540 Models



Standard Decor
BAR540

Designer Decor
BAR540DS

—

—

PORTABLE CAMBARS® PACKAGES & ACCESSORIES

STANDARD EQUIPMENT, SODA GUNS, STANDARD AND DESIGNER DECOR PACKAGES

STANDARD DECOR EQUIPMENT	ECONOMY			BASIC SYSTEM			COMPLETE SYSTEM POST-MIX (Bag in Box)			COMPLETE SYSTEM PRE-MIX (Canisters)	
	BAR540	BAR650	BAR730	BAR650CP	BAR730CP	BAR650PM	BAR650PMT	BAR730PM	BAR730PMT	BAR650DX	BAR730DX
DESIGNER DECOR EQUIPMENT	BAR540DS	BAR650DS	BAR730DS	BAR650DSCP	BAR730DSCP	BAR650DSPM	BAR650DSPMT	BAR730DSPM	BAR730DSPMT	BAR650DSDX	BAR730DSDX
Bag In Box Syrup Pumps						3 ea	3 ea	6 ea	6 ea		
Bag In Box Rack (Holds 3ea Boxes)						1	1	2	2		
Carbonator						YES	YES	YES	YES		
CO ₂ Regulator						YES	YES	YES	YES	YES	YES
CO ₂ Clamp & Chain				YES	YES	YES	YES	YES	YES	YES	YES
Ice Sink 8 - Circuit Cold Plate				YES	YES	YES	YES	YES	YES	YES	YES
Ice Sink Cover	Sink only	YES	YES	YES	YES	YES	YES	YES	YES	YES	YES
Retainer Strap		1	2	1	2	1	1	2	2	1	2
Soda Gun (5, 6 or 8 buttons)						5	5	8	8	5	6
Speed Rail (5 or 7 bottle)	5	7	7	7	7	7	7	7	7	7	7
Water Pump							YES		YES		
Water Tank							YES		YES		
Water Line Hook Up (city source)						YES		YES			
Waste Water Bin		YES	YES	YES	YES	YES	YES	YES	YES	YES	YES
Vinyl Cover	YES	YES	YES	YES	YES	YES	YES	YES	YES	YES	YES

Casters: All BAR540 Models - Four 12,7 cm swivel, two with brake. All BAR650 and BAR730 Models - Four 15,24 cm swivel, two with brake.

Soda Guns by Wunder-Bar®

- Fast, low foaming delivery.
- Two year warranty from Wunder-Bar.
- Includes holster with overflow drain.
- Available with complete systems only.



Post-Mix 8 Button
(BAR730 Complete System)



Post-Mix 5 Button
(BAR650 Complete System)



Pre-Mix 6 Button
(BAR730 Complete System)



Pre-Mix 5 Button
(BAR650 Complete System)

Standard Decor Colors BAR540, BAR650, BAR730



110
Black



191
Granite Gray



194
Granite Sand

BAR650, BAR730 Only

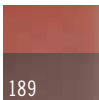

189
Two-Tone Brown
Mahogany



420
Granite Gray
w/ Black Base

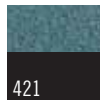

421
Granite Green
w/ Black Base

BAR540 Only



131
Dark Brown



157
Coffee Beige

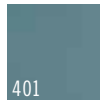

401
Slate Blue

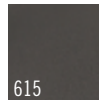

615
Charcoal Gray

Designer Decor BAR650, BAR730 Only

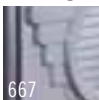

667
Manhattan

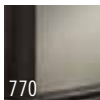

770
Chicago

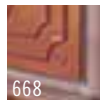

668
Sedona

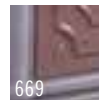

669
Carmel

BAR540 Designer Decor color options are listed with BAR540 details.

Exclusive Cold Plate

- Patented “roof top” design allows for melted ice water to drain into the bottom of the ice sink and into the waste-water bin.
- Circuit exposure through cold plate chills liquids dispensed from the soda gun.



Cold Plate is covered under
U.S. Patent 5,743,602.

Optional Accessories for CamBars

CODE	DESCRIPTION
650WS	Wire shelf for BAR650's
730WS	Wire shelf for BAR730's
730SR	7 bottle speed rail
BAR54SR	5 bottle speed rail

Case Pack: 1

730SR Speed Rail Colors: Black (110), Dark Brown (131), Granite Gray (191).

BAR54SR Speed Rail Colors: Black (110), Dark Brown (131), Coffee Beige (157), Granite Gray (191), Granite Sand (194), Slate Blue (401).

LARGE CAMBARS® – COMPLETE SYSTEMS BAR730

Post-mix System for 18,9 L, Bag-in-box Syrups
Holds up to 6 syrup boxes and 1 CO₂ tank.

BAR730PM and BAR730DSPM

Includes the standard equipment from the Basic System plus:

- Post-mix soda gun with 8 buttons.
- Carbonator.
- 2 stainless steel bag-in-box wire racks.
- 6 bag-in-box pumps.
- CO₂ regulator gauge & tubing, hose & lines.
- Line for city water hook-up.

BAR730PMT, BAR730DSPMT, BAR730PMT220 and BAR730DSPMT2

Includes all of the above plus 1, 64,3 L water tank and 1 water pump.
Line for city water hook-up is not included.



BAR730SDSX Shown in Designer Decor Carmel (669).



Cold plate



Pump and Carbonator

BAR730DSPMT
Shown with water tank and bag-in-box racks.



Vinyl cover included with all CamBars.
Cover not NSF listed.

CODE	VOLTS	WATER TANK	DIMENSIONS L x W x H	UNIT WEIGHT
Standard Decor				
BAR730PM	110	No	184,8 x 66 x 121,9 cm	152 kg
BAR730PMT	110	Yes	184,8 x 66 x 121,9	157
BAR730PMT220	220	Yes	184,8 x 66 x 121,9	157
Designer Decor				
BAR730DSPM	110	No	197,2 x 72,4 x 120,7	176
BAR730DSPMT	110	Yes	197,2 x 72,4 x 120,7	181
BAR730DSPMT2	220	Yes	197,2 x 72,4 x 120,7	181

Pre-mix System for 18,9 L Soda Canisters
Holds up to 7 canisters and 1 CO₂ tank.

BAR730DX & BAR730SDSX

Includes the standard equipment from the Basic System plus:

- Pre-mix soda gun with 6 buttons.



Cold Plate



BAR730DX

CODE	WATER TANK	DIMENSIONS L x W x H	UNIT WEIGHT
Standard Decor			
BAR730DX	No	184,8 x 66 x 121,2 cm	133 kg
Designer Decor			
BAR730SDSX	Yes	197,2 x 72,4 x 120,7	151

LARGE CAMBARS® – ECONOMY AND BASIC SYSTEMS BAR730

Basic System BAR730 Partially Equipped for Soda Service

Requires customer installation of pre-mix or post-mix soda gun system.

Includes:

- Sealed-in cold plate w/8 circuits.
- CO₂ chain.
- 7-bottle speed rail.
- 36,3 kg capacity ice sink.
- Ice sink cover.
- Waste-water bin.
- 2 retainer straps.
- 4, 15,2 cm swivel casters, 2 with brake.
- Vinyl cover.

CODE	DIMENSIONS L x W x H	UNIT WEIGHT
Standard Decor		
BAR730CP	184,8 x 66 x 121,9 cm	132 kg
Designer Decor		
BAR730DSCP	197,2 x 72,4 x 120,7	146



Cold Plate

BAR730DSCP
Shown with four optional wire racks; see details under Portable CamBar Packages & Accessories.

Economy System BAR730 For Bottle, Can or Mixer Service

Includes:

- 7-bottle speed rail.
- 36,3 kg capacity ice sink.
- Ice sink cover.
- Waste-water bin.
- 2 retainer straps.
- 4, 15,2 cm swivel casters, 2 with brake.
- Vinyl cover.

CODE	DIMENSIONS L x W x H	UNIT WEIGHT
Standard Decor		
BAR730	184,8 x 66 x 121,9 cm	90 kg
Designer Decor		
BAR730DS	197,2 x 72,4 x 120,7	111,2



MID-SIZE CAMBARS® – COMPLETE SYSTEMS BAR650

Post-mix System for 18,9 L Bag-in-box Syrups
Holds up to 3 syrup boxes and 1 CO₂ tank

BAR650PM and BAR650DSPM

Includes the standard equipment from the Basic System plus:

- Post-mix soda gun with 5 buttons.
- Carbonator.
- Stainless steel bag-in-box wire rack.
- 3 bag-in-box pumps.
- CO₂ regulator gauge & tubing, hose & lines.
- Line for city water hook-up.

BAR650PMT, BAR650DSPMT, BAR650PMT220 and BAR650DSPMT2

Includes all of the above plus 1, 64,3 L water tank and 1 water pump.
Line for city water hook-up is not included.

CODE	VOLTS	WATER TANK	DIMENSIONS L x W x H	UNIT WEIGHT
Standard Decor				
BAR650PM	110	No	171,5 x 72,4 x 120,7 cm	137 kg
BAR650PMT	110	Yes	171,5 x 72,4 x 120,7	142
BAR650PMT220	220	Yes	171,5 x 72,4 x 120,7	142
Designer Decor				
BAR650DSPM	110	No	171,5 x 72,4 x 120,7	158
BAR650DSPMT	110	Yes	171,5 x 72,4 x 120,7	163
BAR650DSPMT2	220	Yes	171,5 x 72,4 x 120,7	163



Cold Plate

UL
LISTED
Pump and
Carbonator

BAR650DSPMT
Shown with water tank and bag-in-box rack.

Pre-mix System for 18,9 L Soda Canisters
Holds up to 5 canisters and 1 CO₂ tank

BAR650DX and BAR650SDSX

Includes the standard equipment from the Basic System plus:

- Pre-mix soda gun with 5 buttons.

CODE	DIMENSIONS L x W x H	UNIT WEIGHT
Standard Decor		
BAR650DX	171,5 x 72,4 x 120,7 cm	120,3 kg
Designer Decor		
BAR650SDSX	171,5 x 72,4 x 120,7	142



Cold Plate

BAR650SDSX

MID SIZE AND SMALL CAMBARS® – ECONOMY AND BASIC SYSTEMS

Basic System BAR650 – Mid-Size Model Partially Equipped for Soda Service

Requires customer installation of pre-mix or post-mix soda gun system.

Includes:

- Sealed-in cold plate with 8 circuits.
- CO₂ chain.
- 7-bottle speed rail.
- 36,3 kg capacity ice sink.
- Ice sink cover.
- Waste-water bin.
- Retainer strap.
- 4, 15,2 cm swivel casters, 2 with brake.
- Vinyl cover.

CODE	DIMENSIONS L x W x H	UNIT WEIGHT
Standard Decor		
BAR650CP	171,5 x 72,4 x 120,7 cm	129,3 kg
Designer Decor		
BAR650DSCP	171,5 x 72,4 x 120,7	137



Cold Plate

BAR650DSCP
Shown with two optional wire racks; see details under Portable CamBar Packages & Accessories.

Economy System BAR650 – Mid-Size Model For Bottle, Can or Mixer Service

Includes:

- 7-bottle speed rail.
- 36,3 kg capacity ice sink.
- Ice sink cover.
- Waste-water bin.
- Retainer strap.
- 4, 15,2 cm swivel casters, 2 with brake.
- Vinyl cover.

CODE	DIMENSIONS L x W x H	UNIT WEIGHT
Standard Decor		
BAR650	171,5 x 72,4 x 120,7 cm	78,5 kg
Designer Decor		
BAR650DS	171,5 x 72,4 x 120,7	100



BAR650DS
Shown with two optional wire racks; see details under Portable CamBar Packages & Accessories.

Economy System BAR540 – Small Model For Bottle, Can, or Mixer Service

Includes:

- 5-bottle speed rail.
- 36,3 kg capacity ice sink.
- 4, 12,7 cm swivel casters, 2 with brake.
- Vinyl cover.

CODE	DIMENSIONS L x W x H	UNIT WEIGHT
Standard Decor		
BAR540	137,2 x 65,7 x 117,2 cm	53,1 kg
Designer Decor		
BAR540DS	137,2 x 65,7 x 117,2	56



Designer Decor Colors

BAR540 Only

670 Black Base w/ Coal Counter

671 Granite Gray Base w/ Slate Gray Counter

672 Granite Sand Base w/ Cocoa Counter

BAR540DS

SLIDINGLID™ ICE CADDIES

- Polyethylene body and thick foam insulation hold ice for days.
- Rugged, all-weather exterior will not crack, dent, bubble, chip, rust or break.
- Unique sliding lid slides back and under during use, reducing risk of cross-contamination.
- Recessed well and drain shelf keep ice out of water, extending holding times.
- Recessed, molded-in handles ease lifting and maneuvering.
- Slant top sliding lid units fit under pre/catering tables and counters.

Colors: Black (110), Slate Blue (401), Dark Brown (131), Coffee Beige (157), Granite Grey (191).

SlidingLid Ice Caddies ICS125L, ICS125L4S, ICS125LB are covered by US Patent D 468,071 S. SlidingLid Ice Caddies ICS100L and ICS100L4S are covered by US Patent D 424,883.



ICS175LB (Short) Shown with Rear Easy Wheels.



ICS125L (Short)



ICS100L4S (Short)

ICS100L (Short)



ICS175T (Tall)



ICS175TB (Tall) Shown with Rear Easy Wheels.

Caster Descriptions

Refers to caster type in chart.
All casters are 12,7 cm.

A: 2 fixed, 2 swivel, 1 with brake

A1: 2 swivel, 2 with brakes

B: 4 swivel, 1 with brake

C: 2 swivel, 1 with brake,
2 20,3 cm Easy Wheels

D: 2 swivel, 1 with brake,
2 25,4 cm Easy Wheels

E: 2 swivel, 1 with brake,
2 25,4 cm Wide Easy Wheels



ICS200TB (Tall) Shown with Rear Wide Easy Wheels.



CODE	CAPACITY	EXTERIOR DIMENSIONS W x D x H	CASTER TYPE
Short			
ICS100L	46 kg	57 x 77 x 73 cm	A1
ICS100L4S	46	57 x 77 x 73	B
ICS125L	57	58,5 x 80 x 74,5	A
ICS125LB	57	58,5 x 80 x 74,5	C
ICS175L	80	61 x 95,5 x 74,5	A
ICS175LB	80	61 x 95,5 x 74,5	D
Tall			
ICS125T	57	58,5 x 80 x 88	A
ICS175T	80	58,5 x 86,5 x 95,5	A
ICS175TB	80	58,5 x 86,5 x 95,5	D
ICS200TB	91	58,5 x 86,5 x 100,5	E

Case Pack: 1

WAREWASHING, HANDLING & STORAGE

Camrack® 4-in-1 Warewashing System

Camdollies®

Utility Trucks

Tray & Dish Cart / Tray & Silverware Cart

S-Series Adjustable Dish Caddy

ADC33 Adjustable Dish Caddy

Dish Caddies, Adjustable Tray & Dish Cart

Cambox® Bus Boxes

KD Service Cart and KD Utility Cart

Service Carts



CAMRACK® 4-IN-1 WAREWASHING SYSTEM

The Camrack System will protect glassware and keep it clean until the next event, eliminating the need for rewashing.

Efficient Washing

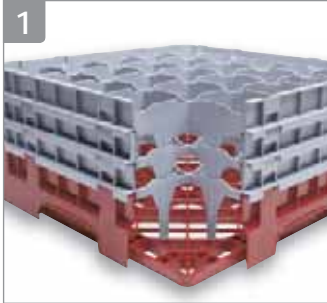

Open inside compartments provide thorough circulation of water and cleaning solutions and promote quick and thorough drying.

Long-lasting polypropylene Camracks are built to withstand chemicals and high temperatures up to 200°F (93°C).

Sanitary Storage



Closed outer walls keep fingers and contaminants out and reduce risk of breakage and injury. The Camrack cover and Camdolly make this system completely enclosed. Glassware stays clean when in storage, so operators will only have to wash items once.

Inventory Control



A variety in base rack colors help identify at a glance both contents and quantity per rack. Available in 10 colors.

Safe, Sanitary Transportation



Camracks can be transported across large campuses or to off-site locations in one single unit.

Easy to grip handles and smooth overlapping sides facilitate safe handling.

Camrack Cover Seals from the Top and Camdolly® Seals from the Bottom.

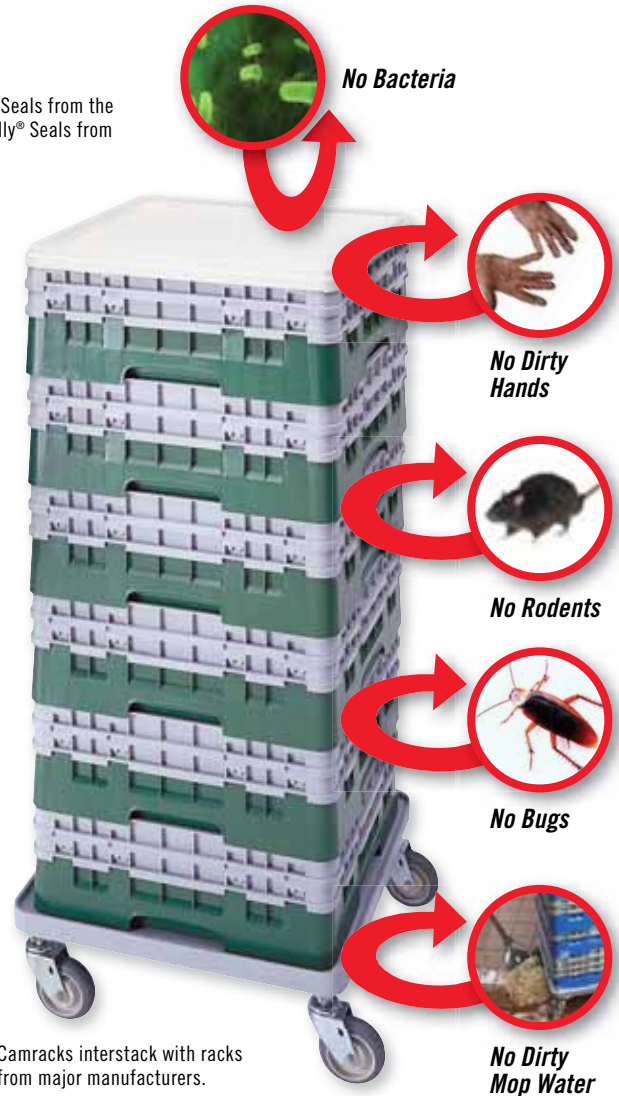

Camracks interstack with racks from major manufacturers.



Content labeling options include one-color custom hot stamping or pre-printed clips.



Camracks are covered by one or more of the following patents: Full Base Dish Rack D 412,607. Half Base Dish Rack D 404,176. Half Dish Rack Extender D 400,321. Enlarged Dish Rack Extender D 399,614. Dish Rack with Extender 5,934,486 Utility Patent. Pronged Base Dish Rack D 403,472.

FULL SIZE CAMRACKS® FOR STEMWARE & TUMBLERS

These racks offer complete protection for all your delicate and valuable stemware and tumblers, from washing and handling to stacking, storing and transporting.

Choose the correct dishrack:

1. Measure the maximum diameter of your glass (stemware or tumbler) to determine the number of compartments.
2. Measure the maximum height of your glass (stemware or tumbler) to the top edge of the rim to determine the compartment height.

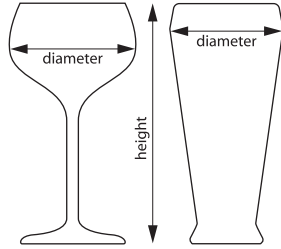

25S534

Camrack Sizing Guides are available at www.cambro.com/mycamracks and on the Cambro App.

14,9 cm
MAXIMUM DIAMETER

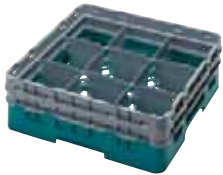

9 COMPARTMENT

	MAXIMUM HEIGHT	9,2 cm	13,3 cm	17,4 cm	21,5 cm	25,7 cm	29,8 cm
CODE		9S318	9S434	9S638	9S800	9S958	9S1114
CASE PACK		5	4	3	2	2	2
EXT. RACK HEIGHT		14,3 cm	18,4 cm	22,5 cm	26,7 cm	30,8 cm	34,9 cm

11,11 cm
MAXIMUM DIAMETER

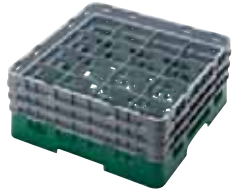

16 COMPARTMENT

	MAXIMUM HEIGHT	9,2 cm	11,4 cm	13,3 cm	15,5 cm	17,4 cm	19,6 cm
CODE		16S318	16S418**	16S434	16S534**	16S638	16S738**
CASE PACK		5	5	4	4	3	3
EXT. RACK HEIGHT		14,3 cm	14,3 cm	18,4 cm	18,4 cm	22,5 cm	22,5 cm
	MAXIMUM HEIGHT	21,5 cm	23,8 cm	25,7 cm	27,9 cm	29,8 cm	32 cm
CODE		16S800	16S900**	16S958	16S1058**	16S1114	16S1214**
CASE PACK		2	2	2	2	2	2
EXT. RACK HEIGHT		26,7 cm	26,7 cm	30,8 cm	30,8 cm	34,9 cm	34,9 cm

Base Rack Colors:

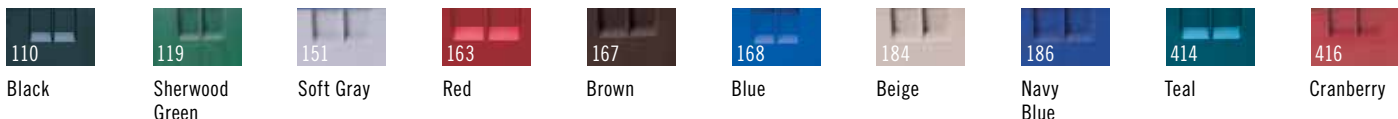

Extender Color: Soft Gray (151). ** Compartment Extenders cannot be added. Personalization available. See Camrack personalization and color coding page. For a more accurate color representation, call your sales rep for actual color chips. Contact Customer Service for all special orders.

FULL SIZE CAMRACKS® FOR STEMWARE & TUMBLERS

Match a glass to a rack at www.cambro.com/Reference_Guides.

9,84 cm
MAXIMUM DIAMETER



20 COMPARTMENT

	MAXIMUM HEIGHT	9,2 cm	11,4 cm	13,3 cm	15,5 cm	17,4 cm	19,6 cm
CODE		20S318	20S418**	20S434	20S534**	20S638	20S738**
CASE PACK		5	5	4	4	3	3
EXT. RACK HEIGHT		14,3 cm	14,3 cm	18,4 cm	18,4 cm	22,5 cm	22,5 cm
	MAXIMUM HEIGHT	21,5 cm	23,8 cm	25,7 cm	27,9 cm	29,8 cm	32 cm
CODE		20S800	20S900**	20S958	20S1058**	20S1114	20S1214**
CASE PACK		2	2	2	2	2	2
EXT. RACK HEIGHT		26,7 cm	26,7 cm	30,8 cm	30,8 cm	34,9 cm	34,9 cm

** Compartment Extenders cannot be added.

8,7 cm
MAXIMUM DIAMETER



25 COMPARTMENT

	MAXIMUM HEIGHT	9,2 cm	11,4 cm	13,3 cm	15,5 cm	17,4 cm	19,6 cm
CODE		25S318	25S418**	25S434	25S534**	25S638	25S738**
CASE PACK		5	5	4	4	3	3
EXT. RACK HEIGHT		14,3 cm	14,3 cm	18,4 cm	18,4 cm	22,5 cm	22,5 cm
	MAXIMUM HEIGHT	21,5 cm	23,8 cm	25,7 cm	27,9 cm	29,8 cm	32 cm
CODE		25S800	25S900**	25S958	25S1058**	25S1114	25S1214**
CASE PACK		2	2	2	2	2	2
EXT. RACK HEIGHT		26,7 cm	26,7 cm	30,8 cm	30,8 cm	34,9 cm	34,9 cm

** Compartment Extenders cannot be added.

7,94 cm
MAXIMUM DIAMETER



30 COMPARTMENT

	MAXIMUM HEIGHT	9,2 cm	13,3 cm	17,4 cm	21,5 cm	25,7 cm	29,8 cm
CODE		30S318	30S434	30S638	30S800	30S958	30S1114
CASE PACK		5	4	3	2	2	2
EXT. RACK HEIGHT		14,3 cm	18,4 cm	22,5 cm	6,7 cm	30,8 cm	4,9 cm

FULL SIZE CAMRACKS® FOR STEMWARE & TUMBLERS

7,3 cm
MAXIMUM DIAMETER



36 COMPARTMENT

MAXIMUM HEIGHT	9,2 cm	11,4 cm	13,3 cm	15,5 cm	17,4 cm	19,6 cm
CODE	36S318	36S418**	36S434	36S534**	36S638	36S738**
CASE PACK	5	5	4	4	3	3
EXT. RACK HEIGHT	14,3 cm	14,3 cm	18,4 cm	18,4 cm	22,5 cm	22,5 cm
MAXIMUM HEIGHT	21,5 cm	23,8 cm	25,7 cm	27,9 cm	29,8 cm	32 cm
CODE	36S800	36S900**	36S958	36S1058**	36S1114	36S1214**
CASE PACK	2	2	2	2	2	2
EXT. RACK HEIGHT	26,7 cm	26,7 cm	30,8 cm	30,8 cm	34,9 cm	34,9 cm

6,2 cm
MAXIMUM DIAMETER



49 COMPARTMENT

MAXIMUM HEIGHT	9,2 cm	13,3 cm	17,4 cm	21,5 cm	25,7 cm	29,8 cm
CODE	49S318	49S434	49S638	49S800	49S958	49S1114
CASE PACK	5	4	3	2	2	2
EXT. RACK HEIGHT	14,3 cm	18,4 cm	22,5 cm	26,7 cm	30,8 cm	34,9 cm



Base Rack Colors:

110	119	151	163	167	168	184	186	414	416
Black	Sherwood Green	Soft Gray	Red	Brown	Blue	Beige	Navy Blue	Teal	Cranberry

Extender Color: Soft Grey (151). ** Compartment Extenders cannot be added. Personalization available. See Camrack personalization and color coding page. For a more accurate color representation, call your sales rep for actual color chips. Contact Customer Service for all special orders.

HALF SIZE CAMRACKS® FOR STEMWARE & TUMBLERS

- Very effective for carrying less weight and for storing drinkware in space-restricted locations.
- Ideal for small under-counter glasswashers.

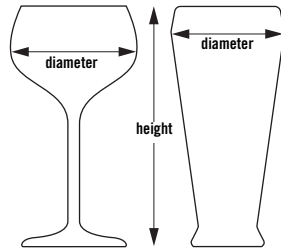

Match a glass to a rack at www.cambro.com/Reference_Guides.

8 COMPARTMENT

10,3 cm
MAXIMUM DIAMETER



MAXIMUM HEIGHT	9,2 cm	13,3 cm	17,4 cm	21,5 cm	25,7 cm	29,8 cm
CODE	8HS318	8HS434	8HS638	8HS800	8HS958	8HS1114
CASE PACK	5	4	3	2	2	2
EXT. RACK HEIGHT	14,3 cm	18,4 cm	22,5 cm	26,7 cm	30,8 cm	34,9 cm

10 COMPARTMENT

8,7 cm
MAXIMUM DIAMETER



MAXIMUM HEIGHT	9,2 cm	13,3 cm	17,4 cm	21,5 cm	25,7 cm	29,8 cm
CODE	10HS318	10HS434	10HS638	10HS800	10HS958	10HS1114
CASE PACK	5	4	3	2	2	2
EXT. RACK HEIGHT	14,3 cm	18,4 cm	22,5 cm	26,7 cm	30,8 cm	34,9 cm

17 COMPARTMENT

7,3 cm
MAXIMUM DIAMETER



MAXIMUM HEIGHT	9,2 cm	13,3 cm	17,4 cm	21,5 cm	25,7 cm	29,8 cm
CODE	17HS318	17HS434	17HS638	17HS800	17HS958	17HS1114
CASE PACK	5	4	3	2	2	2
EXT. RACK HEIGHT	14,3 cm	18,4 cm	22,5 cm	26,7 cm	30,8 cm	34,9 cm

Base Rack Colors:



Sherwood Green

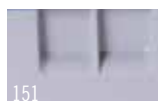

Soft Grey

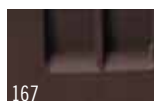

Brown

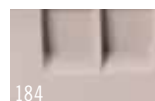

Beige



Navy Blue



Cranberry

Extender Color: Soft Grey (151). Personalization available. See Camrack personalization and color coding page. For a more accurate color representation, call your sales rep for actual color chips. Contact Customer Service for all special orders.

CAMRACK® FULL & HALF SIZE CUP RACKS

- Tilt feature drains water from mug or cup bases for quick and sanitary drying.

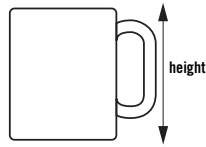

11,1 x 10,95 cm

COMPARTMENT DIMENSIONS



16 COMPARTMENT

	MAXIMUM HEIGHT	6,6 cm	10,7 cm	14,9 cm
CODE		16C258	16C414	16C578
CASE PACK		6	5	4
EXT. RACK HEIGHT		10,1 cm	14,3 cm	18,4 cm

11,1 x 8,73 cm

COMPARTMENT DIMENSIONS



20 COMPARTMENT

	MAXIMUM HEIGHT	6,6 cm	10,7 cm
CODE		20C258	20C414
CASE PACK		6	5
EXT. RACK HEIGHT		10,1 cm	14,3 cm



10,4 x 11,1 cm

COMPARTMENT DIMENSIONS



8 COMPARTMENT

	MAXIMUM HEIGHT	6,6 cm	10,7 cm
CODE		8HC258	8HC414
CASE PACK		6	5
EXT. RACK HEIGHT		10,1 cm	14,3 cm

10,4 x 8,73 cm

COMPARTMENT DIMENSIONS



10 COMPARTMENT

	MAXIMUM HEIGHT	6,6 cm	10,7 cm
CODE		10HC258	10HC414
CASE PACK		6	5
EXT. RACK HEIGHT		10,1 cm	14,3 cm

Glass and Cup Keepers

- Raised ribs for easy draining and drying.
- Holds 20 glasses or 12 cups per layer.

Color: Beige (133)



Max. Glass Inside
Rim Diameter:
GK2000: 6,6 cm



Max. Cup Inside
Rim Diameter:
KK1200: 7,4 cm

CODE	SIZE	CASE PACK
Glass Keepers		
GK2000 (Regal)	35,6 x 45,7 cm	12
Cup Keepers		
KK1200 (Regal)	35,4 x 45,4	12

Base Cup Rack Color: Soft Grey (151). Extender Color: Soft Grey (151).
Personalization available. See Camrack personalization and color coding page.
Contact Customer Service for all special orders.

STORE AND TRANSPORT GLASSES & DISHES

Camrack® Cover & Camdolly®

- Use to cover and protect full size Camrack dishracks filled with clean dishware.
- When used with a Camdolly, creates a portable sanitary storage system that protects contents between uses.
- Eliminates the use of messy, wasteful plastic wrap or vinyl covers.



FULL RACK COVER

CODE	DRC2020
EXTERIOR DIMENSIONS	50 x 50 x 2,4 cm

Case Pack: 1 Color: Grey (180).

CAMDOLLY

	CAMDOLLY	CAMDOLLY WITH HANDLE
CODE	CDR2020	CDR2020H
INTERIOR DIMENSIONS	53 x 53 cm	53 x 53 cm
EXTERIOR DIMENSIONS	54,5 x 54,5 x 20,5 cm	54,5 x 59,5 x 94 cm
LOAD CAPACITY	159 kg	159 kg

Case Pack: 1 Color: Soft Grey (151). Casters: 10 cm casters, 4 swivel, no brakes.

Camrack IceExpress Glass Filler

- Dramatically reduces banquet set-up time.
- Fills 25 glasses with ice all at once.

- Reduces breakage and risk of contamination.
- Ice falls directly into glasses with no spills or drips.



CODE	EXTERIOR DIMENSIONS W x D x H
25SWGf	50,8 x 50,8 x 3,18 cm

Case Pack: 1 Color: Black (110).

SELECTING THE RIGHT CAMRACK

Selecting the Right Camrack

Cambro offers multiple ways to help you quickly find the right Camrack:

1. www.cambro.com/mycamracks

To quickly find the correct Camrack, please visit www.cambro.com/mycamracks. Select the item you are sizing, enter the measurements and quantity of the item, and the right Camrack will appear on the page.

2. Cambro Catalog

Flip to the back of this section for a convenient stemware and glass sizing reference guide.

3. Cambro Sales Representatives

Contact your local Cambro representative and he or she will walk through your current ware

handling system with you and specify Camracks, dollies and covers that will fit your glasses and dishware. To find your local representative refer to the back section of this catalog, visit www.cambro.com and click on "Find a Sales Rep" on the lower left of your screen or call the Cambro Customer Service line: 31-168-707-210.

4. Send a Sample to Cambro

C.E.L. Customer Service.
Kelterstrasse 51
72669 Unterensingen, Germany.

Please be sure to include complete contact information and specify if you need full-size or half-size Camracks.

Choose the correct Camrack:

1. Measure the maximum diameter of the glass (stemware or tumbler) to determine the number of compartments.
2. Measure the maximum height of the glass (stemware or tumbler) to the top edge of the rim to determine the compartment height.

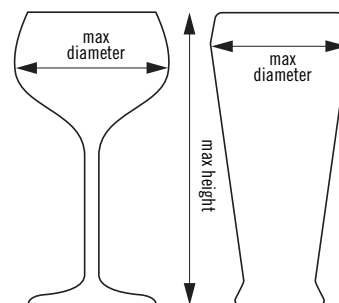

Download the Cambro App:

Find the right Camrack for your Glassware by entering the height and maximum diameter of your glass.



CAMRACK® BASE RACKS

- For pots, pans, bowls and large prep, service and display items.
- Half racks work well for storing items at a wait station.



BR578

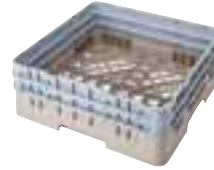
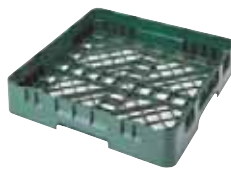

FULL SIZE BASE RACKS

	FULL BASE RACK	WITH 1 EXTENDER	WITH 2 EXTENDERS	WITH 3 EXTENDERS
CODE	BR258	BR414	BR578	BR712
INSIDE RACK HEIGHT	8,3 cm	12,4 cm	16,5 cm	20,6 cm
OUTSIDE RACK HEIGHT	10,1 cm	14,3 cm	18,4 cm	22,5 cm
CASE PACK	6	5	4	3



HALF SIZE BASE RACKS

	HALF BASE RACK	WITH 1 EXTENDER	WITH 2 EXTENDERS	WITH 3 EXTENDERS
CODE	HBR258	HBR414	HBR578	HBR712
INSIDE RACK HEIGHT	8,3 cm	12,4 cm	16,5 cm	20,6 cm
OUTSIDE RACK HEIGHT	10,1 cm	14,3 cm	18,4 cm	22,5 cm
CASE PACK	6	5	4	3

Hold Down Grid

Keeps lightweight smallwares in place during wash cycle. Use on full size Camrack base rack.



CRPHDG2878

FULL SIZE HOLD DOWN GRID

CODE	CRPHDG2878
Case Pack: 6	Color: Gray (000).

Base Rack Colors:

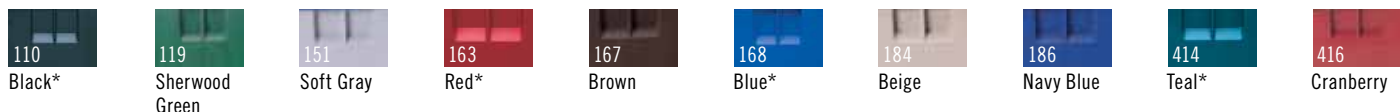

*Full size only. Extender Color: Soft Grey (151). Personalization available. See Camrack personalization and color coding page. For a more accurate color representation, call your sales rep for actual color chips. Contact Customer Service for all special orders.

CAMRACK® FULL SIZE PEG RACKS & TRAY RACK

Standard 9 x 9 Peg Rack

- Designed to wash varying sized plates, bowls, trays and plate covers.
- Standard peg racks hold:
 - Eighteen 25,4 cm plates
 - Twelve 30,5 cm plates
 - Twenty-seven 19 cm plates
 or
 - Nine 36 x 46 cm trays

5 x 9 Peg Rack

- Holds standard plates in one direction or deep plates, bowls and plate covers in the other direction.
- 5 spacing configuration holds up to ten 25,4 cm bowls, deep plates, platters or plate covers.

- 9 spacing configuration holds up to:

- Eighteen 25,4 cm plates
 - Twelve 30,5 cm plates
 - Twenty-seven 19 cm plates
- or
- Nine 36 x 46 cm trays

Open End Tray Rack

- Holds cafeteria trays or full-size sheet pans.
- Open-ended on one side for easy placement and removal of trays of all lengths.
- Holds up to nine trays upright.



9 X 9 PEG RACK

9 X 9 PEG RACK WITH 1 EXTENDER

5 X 9 PEG RACK

5 X 9 PEG RACK WITH 1 EXTENDER

OPEN END TRAY RACK

	9 X 9 PEG RACK	9 X 9 PEG RACK WITH 1 EXTENDER	5 X 9 PEG RACK	5 X 9 PEG RACK WITH 1 EXTENDER	OPEN END TRAY RACK
CODE	PR314	PR500	PR59314	PR59500	OETR314*
INSIDE RACK HEIGHT	8,3 cm	12,4 cm	8,3 cm	12,4 cm	8,3 cm
OUTSIDE RACK HEIGHT	10,1 cm	14,3 cm	10,1 cm	14,3 cm	10,1 cm
CASE PACK	6	5	6	5	6

Color: Soft Gray (151). **Extender Color:** Soft Gray (151). **InStock Color:** Soft Gray (151). Personalization available. See Camrack personalization and color coding page. Contact Customer Service for all special orders. *Extenders may be added to all Peg Racks except the OETR314.

CAMRACK FULL & HALF SIZE FLATWARE RACKS & CYLINDER

- 8 Compartment Basket fits into a Full or Half Size Base Rack. Wire handles slide down for easy storage.

- Flatware Cylinder fits into 9-Compartment Full Size Camrack and the Cambro Tray and Dish Cart, model TDCR12.

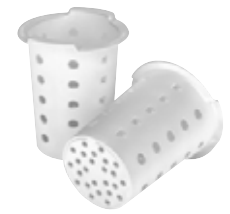
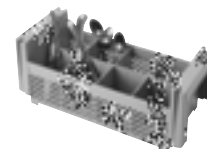
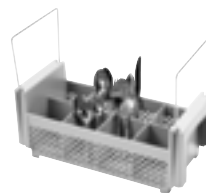

FULL FLATWARE RACK

HALF FLATWARE RACK

8 COMPARTMENT HALF FLATWARE BASKET

8 COMPARTMENT HALF FLATWARE BASKET

FLATWARE CYLINDER

	FULL FLATWARE RACK	HALF FLATWARE RACK	8 COMPARTMENT HALF FLATWARE BASKET	8 COMPARTMENT HALF FLATWARE BASKET	FLATWARE CYLINDER
CODE	FR258	HFR258	8FB434* With Handles	8FBNH434* No Handles	FWC56
INSIDE RACK HEIGHT	6,7 cm	6,7 cm	12 cm	12 cm	Wide 11,4 cm
OUTSIDE RACK HEIGHT	10,1 cm	10,1 cm	18,4 cm	18,4 cm	High 14 cm
CASE PACK	6	6	6	6	12

Color: Soft Gray (151). **Extender Color:** Soft Gray (151). **InStock Color:** Soft Gray (151). **Flatware Cylinder Color:** White (148). Personalization available. See Camrack personalization and color coding page. Contact Customer Service for all special orders. *Extenders cannot be added.

THE CAMRACK® COMPONENT SYSTEM

The Camrack System offers several choices for ordering the right Camracks now and as your needs change. Please consult with your sales representative or Cambro Customer Service for all special ordering and assembly directions.

Choose Between:

1. A complete selection of pre-assembled, ready to use Camracks listed in our catalog; or
2. Custom built special order Camracks for specific needs; or
3. Individual Camrack components for distributors to stock and build racks as needed.

Base Rack Colors:

Sherwood Green (119), Soft Grey (151), Brown (167), Beige (184), Navy Blue (186), Cranberry (416), Black (110)*, Red (163)*, Blue (168)*, Teal (414)*.

Base Cup Rack Color: Soft Grey (151).

Extender Color: Soft Grey (151).

Personalization available.

Full Base Racks are covered by U.S. Patent D 412,607.

Half Base Racks are covered by U.S. Patent D 404,176.

* Full size only.

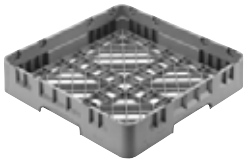

BR = Full Size Base Rack



HBR = Half Size Base Rack



E1 = Full Size Full Drop Compartment Extender

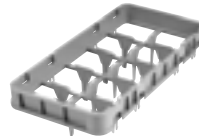

HE1 = Half Size Full Drop Compartment Extender



E2 = Full Size Half Drop Compartment Extender



HE2 = Half Size Half Drop Compartment Extender

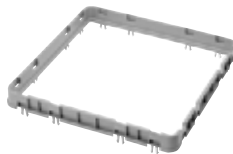

E3 = Full Size Open Extender

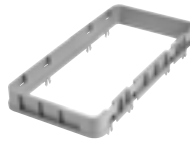

HE3 = Half Size Open Extender



E4 = Full Size Full Drop Stemware Extender

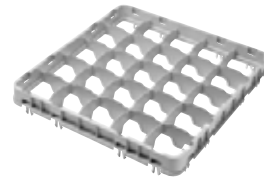

E5 = Full Size Half Drop Stemware Extender

Only E3 extenders may be added to E4's and E5's.

Camracks Components

CODE	DESCRIPTION	EXTERIOR DIMENSIONS	COMPARTMENT	INSIDE RACK HEIGHT	CASE PACK
Full Size Base Racks					
BR258*	Full Base Rack	500 x 500 x 101 mm	457 x 457 mm	67 mm	6
Half Size Base Racks					
HBR258	Half Base Rack	500 x 250 x 101	464 x 213	67	6
Full Size Base Cup Racks					
16C258	16-Compartment Full Cup Rack	500 x 500 x 101	111 x 111	67	6
20C258	20-Compartment Full Cup Rack	500 x 500 x 101	111 x 89	67	6
Half Size Base Cup Racks					
8HC258	8-Compartment Half Cup Rack	500 x 250 x 101	105 x 113	67	6
10HC258	10-Compartment Half Cup Rack	500 x 250 x 101	105 x 89	67	6
Full Size Full Drop Extenders – E1 and GE1					
9E1	9-Compartment Full Drop Extender	499 x 499 x 51	150 x 150	41	12
16E1	16-Compartment Full Drop Extender	499 x 499 x 51	111 x 111	41	12
20GE1	20-Compartment Full Drop Extender	499 x 499 x 51	98 x 98	41	12
25E1	25-Compartment Full Drop Extender	499 x 499 x 51	89 x 89	41	12
30GE1	30-Compartment Full Drop Extender	499 x 499 x 51	79 x 79	41	12
36E1	36-Compartment Full Drop Extender	499 x 499 x 51	73 x 73	41	12
49E1	49-Compartment Full Drop Extender	499 x 499 x 51	62 x 62	41	12

THE CAMRACK® COMPONENT SYSTEM

CODE	DESCRIPTION	EXTERIOR DIMENSIONS	COMPARTMENT	INSIDE RACK HEIGHT	CASE PACK
Full Size Half Drop Extenders – E2 and GE2					
9E2	9-Compartment Half Drop Extender	499 x 499 x 51 mm	150 x 150 mm	41 mm	12
16E2	16-Compartment Half Drop Extender	499 x 499 x 51	111 x 111	41	12
20E2	20-Compartment Half Drop Extender (for cups only)	499 x 499 x 51	111 x 89	41	12
20GE2	20-Compartment Half Drop Extender	499 x 499 x 51	98 x 98	41	12
25E2	25-Compartment Half Drop Extender	499 x 499 x 51	89 x 89	41	12
30GE2	30-Compartment Half Drop Extender	499 x 499 x 51	79 x 79	41	12
36E2	36-Compartment Half Drop Extender	499 x 499 x 51	73 x 73	41	12
49E2	49-Compartment Half Drop Extender	499 x 499 x 51	62 x 62	41	12
Full Size Open Extender – E3					
E3	Open Extender	499 x 499 x 51	457 x 457	41	12
Full Size Full Drop Extenders – E4					
16E4	16-Compartment Full Drop Extender	499 x 499 x 51	111 x 111	41	12
20GE4	20-Compartment Full Drop Extender	499 x 499 x 51	98 x 98	41	12
25E4	25-Compartment Full Drop Extender	499 x 499 x 51	89 x 89	41	12
36E4	36-Compartment Full Drop Extender	499 x 499 x 51	73 x 73	41	12
Full Size Half Drop Extenders – E5					
16E5	16-Compartment Half Drop Extender	499 x 499 x 51	111 x 111	41	12
20GE5	20-Compartment Half Drop Extender	499 x 499 x 51	98 x 98	41	12
25E5	25-Compartment Half Drop Extender	499 x 499 x 51	89 x 89	41	12
36E5	36-Compartment Half Drop Extender	499 x 499 x 51	73 x 73	41	12
Half Size Full Drop Extenders – HE1					
8HE1	8-Compartment Full Drop Extender	502 x 252 x 51	105 x 113	41	12
10HE1	10-Compartment Full Drop Extender	502 x 252 x 51	105 x 89	41	12
17HE1	17-Compartment Full Drop Extender	502 x 252 x 51	74 diameter	41	12
Half Size Half Drop Extenders – HE2					
8HE2	8-Compartment Half Drop Extender	502 x 252 x 51	105 x 113	41	12
10HE2	10-Compartment Half Drop Extender	502 x 252 x 51	105 x 89	41	12
17HE2	17-Compartment Half Drop Extender	502 x 252 x 51	74 diameter	41	12
Half Size Open Extender – HE3					
HE3	Open Extender	502 x 252 x 51	464 x 213	41	12

Base Rack Colors: Sherwood Green (119), Soft Gray (151), Brown (167), Beige (184), Navy Blue (186), Cranberry (416), Black (110)*, Red (163)*, Blue (168)*, Teal (414)*.
Base Cup Rack Color: Soft Gray (151). **Extender Color:** Soft Gray (151). * Color available in full size only. All extenders are available in Soft Gray (151). All pre-assembled racks ship with Soft Gray (151) extenders. **PlateSafe Grid Color:** Gray (000).



LET'S GET PERSONAL – PERSONALIZED CAMRACKS®

Personalize Camracks to identify contents at a glance for accurate inventory control and selection.

Hot stamp a custom logo, information or standard content symbols, and/or descriptions on two opposite, diagonal sides of any rack.

Or request the addition of pre-printed clips. Up to 4 Camrack or PlateSafe clips can be added only at time of assembly and require the addition of at least one extender.



IMPRINT COLOR-WHITE

HOW TO ORDER A SAMPLE

1. Contact your local Cambro rep to complete and submit a sample request form to Cambro.
2. Select rack size, code and color. Imprint color - white only.
3. Choose process A) Hot Stamp or B) Camrack Clips
4. Indicate location of hot stamp and or clip on rack. Maximum hot stamp imprint size is W 102 x H 31,7 mm. Maximum hot stamp imprinting thickness per solid letter or logo should be no more than 102 mm wide.
5. If selecting process A with a custom hot stamp, provide ready to use artwork, digital format only. Sample request form must be submitted to Cambro PRIOR to artwork being sent. If artwork is incomplete, graphic support services are available for ** per hour.

6. Submit Artwork

E-mail artwork to your Cambro Rep or direct to Cambro at letsgetpersonal@cambro.com. Title e-mail subject with logo name and provide contact info. **File dimensions:** 100% reproduction size, 300dpi resolution. **File type:** Adobe® Illustrator®, Photoshop®. **File format:** jpeg, tiff, and eps. Or mail digital artwork to: Cambro Manufacturing Company. Attn: Kristie Patterson, 7601 Clay Avenue, Huntington Beach, CA 92648.

7. Questions regarding artwork?

Tel: (49)7022-90-100-0; Ireland Tel: 1800 509 046; for UK Tel: 0800 587 0057 or Fax: (49)7022-90-100-19.

8. Sample Approval

A signed sample approval form must be faxed to Cambro customer service prior to processing any purchase orders. This form is included with each sample.

PERSONALIZATION CHARGES

- One Time Plate Charge** ** for custom hot stamp only
- Set-Up Charge** **
- Sample Charge** **
- Imprint Charge** ** per side, 2 sides max.

FOR CLIPS

Drinkware or PlateSafe®, pre-printed ** each

** Contact your Cambro representative for pricing.

STANDARD HOT STAMP SYMBOLS AND/OR DESCRIPTIONS

Step 1. Choose a symbol and corresponding letter that best fits your glassware.

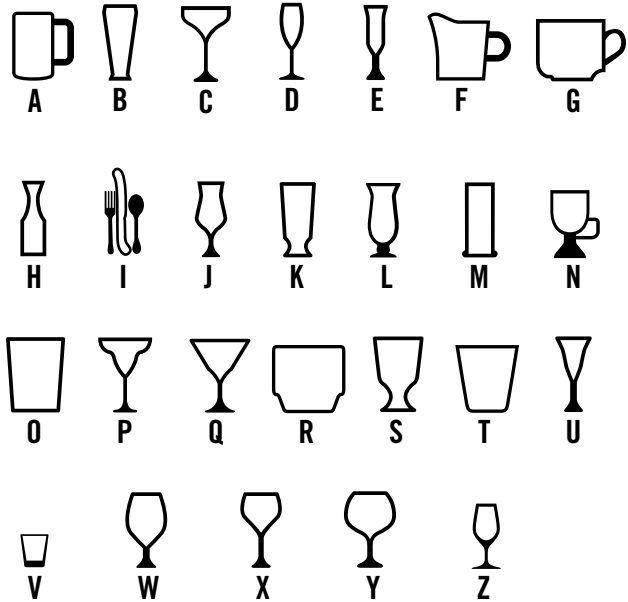

Step 2. Choose the verbiage and corresponding number that best describes your glassware. **Available in English Only.**

- | | | |
|--------------------|--------------------------|---------------------------|
| 1. Beer | 13. Flatware | 25. Rocks (Tumbler Style) |
| 2. Beer Mug | 14. Goblet | 26. Sherry |
| 3. Pilsner | 15. Grande | 27. Shot Glass |
| 4. Brandy | 16. Hi-Ball | 28. Sorbet |
| 5. Champagne | 17. Hurricane | 29. Water (Footed Style) |
| 6. Champagne Flute | 18. Iced Tea | 30. Water (Tumbler Style) |
| 7. Coffee Mug | 19. Irish Coffee | 31. White Wine |
| 8. Collins | 20. Juice | 32. Wine |
| 9. Cordial | 21. Margarita | 33. Red Wine |
| 10. Creamer | 22. Martini | 34. Port |
| 11. Cup | 23. Old Fashion | |
| 12. Decanter | 24. Rocks (Footed Style) | |

PERSONALIZATION OPTIONS

HOT STAMPING



CUSTOM LOGO AND/OR TEXT



STANDARD SYMBOL AND DESCRIPTION



STANDARD SYMBOL ONLY





































STANDARD DESCRIPTION ONLY

CAMRACK® EXTENDER ID CLIP

- The industry's only 4-in-1 glassware management system just got even better!
- Made of ABS, these new clips are virtually unbreakable, and designed to withstand the high heat of commercial dishwashers.
- An economical and sustainable solution to discarding existing racks or labeling with markers, tape or wall placards.



PRE-PRINTED CLIPS (Available in 6-packs) Contact your Cambro representative for pricing.

CODE			CODE			CODE		
	Beer	CECBE6000		Goblet	CECGO6000		Rocks (Footed Style)	CECRF6000
	Beer Mug	CECBM6000		Grande	CECGR6000		Rocks (Tumbler Style)	CECRT6000
	Brandy	CECBR6000		Hi-Ball	CECHB6000		Sherry	CECSH6000
	Champagne	CECCH6000		Hurricane	CECHU6000		Shot Glass	CECSG6000
	Champagne Flute	CECCF6000		Iced Tea	CECIT6000		Sorbet	CECSB6000
	Coffee Mug	CECCM6000		Irish Coffee	CECIC6000		Water (Footed Style)	CECWF6000
	Collins	CECCL6000		Juice	CECJU6000		Water (Tumbler Style)	CECWT6000
	Cordial	CECCO6000		Margarita	CECMG6000		White Wine	CECWW6000
	Creamer	CECCR6000		Martini	CECMT6000		Wine	CECWI6000
	Cup	CECCP6000		Old Fashion	CECOF6000		Port	CECPO6000
	Decanter	CECDC6000		Pilsner	CECPI6000			CECBL6000 Blank Clip
	Flatware	CECFL6000		Red Wine	CECRW6000			

(Available in English Only)

- Use to transport anything from stacks of sheet pans to catering equipment.
- Reduce employee lifting and carrying, reducing possible injury.
- Made of extremely durable plastic that will not dent, crack, rust or corrode.
- Heavy-duty casters maneuver easily over all types of terrain.
- For heavy transport needs, select models with handles and rear Big Wheels.

Colors: Coffee Beige (157), Dark Brown (131), Black (110), Slate Blue (401).
CDR2020, CDR2020H Color: Soft Gray (151).

Caster Type

- A:** 12,7 cm Casters: 2 fixed, 2 swivel, 1 with brake.
B: 7,6 cm Casters: 4 swivel, no brakes.
C: 25,4 cm Rear Big Wheels, 2 front 12,7 cm swivel casters, 1 with brake.
D: 8,9 cm Casters: 4 swivel, no brakes.

Available Parcel Carrier Delivery: CDR2020, CDR2020H, CD2020, CD1420, CD2028, CD1313, CD1327, CD100, CD160, CD200, CD300, CD400, CD1826PDB, 2030UT & 400STP.

Camdollies Case Pack: 1

* CDR2020H Not NSF Listed.

STOCK PRODUCTS & COLORS AVAILABLE IN OUR EUROPEAN WAREHOUSE

CDR2020, CDR2020H: (151)

For Dish Racks

EXTERNAL DIM. W x D x H 54,5 x 53 x 18,7 cm
INTERIOR DIM. W x D 53 x 53 cm

159 kg CAPACITY	D CASTER TYPE
---------------------------	-------------------------



CDR2020

EXTERNAL DIM. W x D x H 53 x 64,1 x 92,7 cm
INTERIOR DIM. W x D 53 x 53 cm

159 kg CAPACITY	D CASTER TYPE
---------------------------	-------------------------



CDR2020H*
With powder coated handle.

For 46 x 66 cm Trays and Sheet Pans

EXTERNAL DIM. W x D x H 50,8 x 80 x 97,2 cm
INTERIOR DIM. W x D 46 x 66 cm

Holds: UPC101

136 kg CAPACITY	A CASTER TYPE
---------------------------	-------------------------



CD1826H

EXTERNAL DIM. W x D x H 57 x 57 x 21 cm
INTERIOR DIM. W x D 51,1 x 51,1 cm

Also Holds: 500LCD, 350LCD, 250LCD, 1000LCD, UC1000

136 kg CAPACITY	B CASTER TYPE
---------------------------	-------------------------



CD2020

EXTERNAL DIM. W x D x H 59,7 x 82,6 x 93 cm
INTERIOR DIM. W x D 47 x 66 cm

Holds: UPC101

136 kg CAPACITY	C CASTER TYPE
---------------------------	-------------------------



CD1826HB

EXTERNAL DIM. W x D x H 56,5 x 65,7 x 93,7 cm
INTERIOR DIM. W x D 51,5 x 51,5 cm

Also Holds: 250LCD, 350LCD, 500LCD, 1000LCD

159 kg CAPACITY	B CASTER TYPE
---------------------------	-------------------------



CD2020H

For Pizza Dough Boxes

Also See Pizza Dough Boxes page 146

EXTERNAL DIM. W x D x H 50,5 x 71 x 26 cm
INTERIOR DIM. W x D 44,5 x 64,5 cm

Holds: DB18263CW, DB18266CW, DB18263P

136 kg CAPACITY	A CASTER TYPE
---------------------------	-------------------------



CD1826PDB
Optional strap available.

EXTERNAL DIM. W x D x H 66,7 x 67,3 x 93 cm
INTERIOR DIM. W x D 52 x 52,5 cm

Also Holds: 250LCD, 350LCD, 500LCD

159 kg CAPACITY	C CASTER TYPE
---------------------------	-------------------------



CD2020HB

CAMDOLLIES®

For Camcarriers® and Camtainers®

EXTERNAL DIM. W x D x H 50 x 73 x 27 cm

INTERIOR DIM. W x D 44 x 66,5 cm

Holds: 100MPC, UPC100, UC250, UC500, 250LCD, 350LCD, 500LCD

136 kg CAPACITY	A CASTER TYPE
---------------------------	-------------------------



CD100



EXTERNAL DIM. W x D x H 50 x 84 x 92 cm

INTERIOR DIM. W x D 45 x 67,5 cm

Holds: 100MPC, UC250, UC500, 250LCD, 350LCD, 500LCD

159 kg CAPACITY	A CASTER TYPE
---------------------------	-------------------------



CD100H



EXTERNAL DIM. W x D x H 60 x 83,5 x 93 cm

INTERIOR DIM. W x D 44,5 x 68 cm

Holds: 100MPC, UPC100, UC250, UC500, 250LCD, 350LCD, 500LCD

159 kg CAPACITY	C CASTER TYPE
---------------------------	-------------------------



CD100HB



EXTERNAL DIM. W x D x H 42 x 62 x 26,5 cm

INTERIOR DIM. W x D 36 x 56 cm

Holds: UPC140, UPC160, UPC180, UPCS140, UPCS160, UPCS180, UPCSS160

136 kg CAPACITY	A CASTER TYPE
---------------------------	-------------------------



CD160



EXTERNAL DIM. W x D x H 49 x 65 x 26,5 cm

INTERIOR DIM. W x D 43 x 59 cm

Holds: 300MPC, 1318MTC, UC1000, 1000LCD

159 kg CAPACITY	A CASTER TYPE
---------------------------	-------------------------



CD300



EXTERNAL DIM. W x D x H 61 x 89,5 x 93 cm

INTERIOR DIM. W x D 56 x 72,5 cm

Holds: 1826MTC

159 kg CAPACITY	A CASTER TYPE
---------------------------	-------------------------



CD1826MTC



EXTERNAL DIM. W x D x H 70 x 88,5 x 93,5 cm

INTERIOR DIM. W x D 55,5 x 72,5 cm

Holds: 1826MTC

159 kg CAPACITY	C CASTER TYPE
---------------------------	-------------------------



CD1826MTC HB



EXTERNAL DIM. W x D x H 48,5 x 76,5 x 92 cm

INTERIOR DIM. W x D 43 x 59 cm

Holds: 300MPC, 1318MTC, UC1000, 1000LCD

159 kg CAPACITY	A CASTER TYPE
---------------------------	-------------------------



CD300H



EXTERNAL DIM. W x D x H 60 x 76 x 92 cm

INTERIOR DIM. W x D 44 x 60 cm

Holds: 300MPC, 1318MTC, UC1000, 1000LCD

159 kg CAPACITY	C CASTER TYPE
---------------------------	-------------------------



CD300HB



EXTERNAL DIM. W x D x H 53 x 70 x 23 cm

INTERIOR DIM. W x D 46 x 63,5 cm

Holds: UPC400, UPCS400, UPCH400

136 kg CAPACITY	A CASTER TYPE
---------------------------	-------------------------



CD400

Shown with
Optional Strap.



CAMDOLLIES®

for Milk Crates and #10 Can Cases

EXTERNAL DIM. W x D x H 41,28 x 55,25 x 21,11 cm
INTERIOR DIM. W x D 35,24 x 49,05 cm

Holds: 35,6 x 48,3 cm Milk Crates and #10 Can Cases

159 kg CAPACITY	B CASTER TYPE		
---------------------------	-------------------------	---	---





CD1420



EXTERNAL DIM. W x D x H 56,6 x 77 x 21 cm
INTERIOR DIM. W x D 49,5 x 71 cm

Holds: 35,6 x 48,3 cm Milk Crates, #10 Can Cases and UPC101, 300MPC, UPC400, 100MPC, UPC100

159 kg CAPACITY	B CASTER TYPE		
---------------------------	-------------------------	---	---





CD2028



EXTERNAL DIM. W x D x H 41 x 41 x 21 cm
INTERIOR DIM. W x D 35 x 35 cm

Holds: 30 x 30 cm Milk Crates

114 kg CAPACITY	B CASTER TYPE		
---------------------------	-------------------------	---	---



CD1313



EXTERNAL DIM. W x D x H 40,6 x 73,7 x 21 cm
INTERIOR DIM. W x D 34,6 x 67,6 cm

Holds: 30 x 30 cm Milk Crates and #10 Can Cases

136 kg CAPACITY	B CASTER TYPE		
---------------------------	-------------------------	---	---



CD1327



UTILITY TRUCKS

- Use for transporting loads of up to 272 kg.
- Large platforms for convenient loading and built-in handles for easy maneuvering.
- All models feature 12,7 cm heavy-duty casters bolted into molded-in metal backing plates.

Colors: Coffee Beige (157), Dark Brown (131), Black (110), Slate Blue (401).

Casters: 12,7 cm, 2 fixed, 2 swivel, 1 with brake.

Utility Trucks Case Pack: 1



2030UT
With chrome handle.
UTHSTP
508 cm long strap.

EXTERNAL DIM. W x D x H 50 x 81,5 x 98 cm
LOAD PLATFORM 50 x 75 cm

272 kg CAPACITY		
---------------------------	---	--

EXTERNAL DIM. W x D x H 63,2 x 106 x 93,3 cm
LOAD PLATFORM 60 x 90,5 cm

272 kg CAPACITY		
---------------------------	---	--



2436UTH
UTHSTP
508 cm Long Strap.

EXTERNAL DIM. W x D x H 63,2 x 106 x 93,3 cm
LOAD PLATFORM 60 x 90,5 cm

272 kg CAPACITY		
---------------------------	---	--



2436UTHS
Includes two straps.

Camdolly® Strap for CD400 and CD1826PDB Camdollies

CODE	DESCRIPTION	EXTERNAL DIM.
400STP	Strap	500 cm long

Case Pack: 1



TRAY & DISH CART / TRAY & SILVERWARE CART

Tray & Dish Cart

- Open storage compartment holds a wide variety of plates and trays.
- Use with or without detachable cutlery station.
- Made of easy-to-clean polyethylene that won't rust, peel or corrode.
- Rounded, molded-in corners protect furniture and walls.
- Molded-in handles and heavy-duty 15,2 cm swivel casters ease maneuvering.

Colors: Black (110), Slate Blue (401), Coffee Beige (157), Dark Brown (131), Granite Grey (191), Granite Green (192).

15,2 cm Casters: All swivel, 2 with brake.

Vinyl cover is not NSF listed.



Flatware cylinders and vinyl cover included with TDCR12.



Vinyl cover included for sanitary storage. TDCR12 only.



TDCR12

CODE	DESCRIPTION	EXTERIOR DIM. L x W x H
TDCR12	Cart & rack combination	97 x 58 x 105 cm
TDC2029*	Cart only	97 x 56,5 x 87
CR12	Cutlery rack only	84 x 58 x 23
FWC56	Flatware cylinder	W 11,4 x H 14

Case Pack: 1 FWC56 Case Pack: 12

* TDC2029 is not available in Black (110).

Tray & Silverware Cart

- Use to neatly organize trays and accessories for self-service.
- Includes eight clear polycarbonate food pans to hold flatware, napkins and non-perishable condiments.
- Protective vinyl cover included.

Colors: Black (110), Slate Blue (401), Coffee Beige (157), Dark Brown (131), Granite Grey (191), Granite Green (192).

15,2 cm Casters: All swivel, 2 with brake.

Vinyl cover is not NSF listed.



TC1418

CODE	DESCRIPTION	CASE PACK
TC1418	Cart w/pans & vinyl cover	1

CODE	EXTERIOR DIM. L x W x H	WEIGHT CAPACITY	MAXIMUM TRAY SIZE	TRAY CAPACITY
TC1418	82 x 54 x 116 cm	227 kg	36 x 46 cm	180-200 in two stacks

Polycarbonate Pans for self-serve top:

PAN QUANTITY, SIZE	CAPACITY
4 each, 1/3 size x 10 cm deep	Holds 100 knives, 100 spoons, 80 forks
4 each, 1/6 size x 10 cm deep	Holds variety of condiments



Use the vinyl cover for sanitary storage (included).

S-SERIES ADJUSTABLE DISH CADDY



- Store one size dish or a combination of different sizes in a single caddy.
- Features easy-to-adjust column towers.

ADCS Colors: Black (110), Slate Blue (401), Speckled Grey (480), Dark Brown (131).

Casters: Two 12,7 cm, swivel with brakes and two 25,4 cm easy wheels.

Vinyl cover included. Not NSF listed.

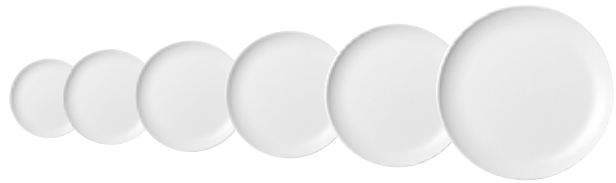

Holds plates and bowls from 11,7 to 33 cm

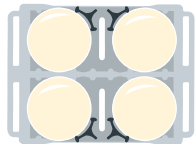

Plate sizes: ø 23,5 cm to 33 cm
4 Columns (60 each)
Total Capacity: 240

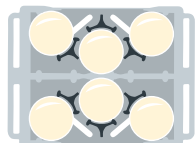

Plate sizes: ø 18,42 cm to 23,5 cm
6 Columns (60 each)
Total Capacity: 360

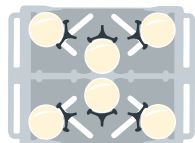
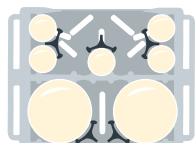
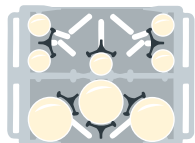

Plate sizes: ø 14,6 cm to 18,42 cm
6 Columns (45 each)
Total Capacity: 270



2 Columns: ø 23,5 cm to 33 cm (60 each)
5 Columns: ø 12,6 cm (45 each)
Total Capacity: 345



3 Columns: ø 18,42 cm to 23,5 cm (60 each)
5 Columns: ø 11,75 cm (45 each)
Total Capacity: 405

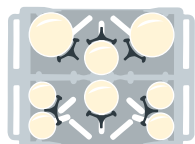

2 Columns: ø 18,42 cm to 23,5 cm (60 each)
2 Columns: ø 14,6 cm to 18,42 cm (45 each)
4 Columns: ø 12,6 cm (45 each)
Total Capacity: 390

STABLE & SECURE

1,27 cm rod from top to bottom of divider.

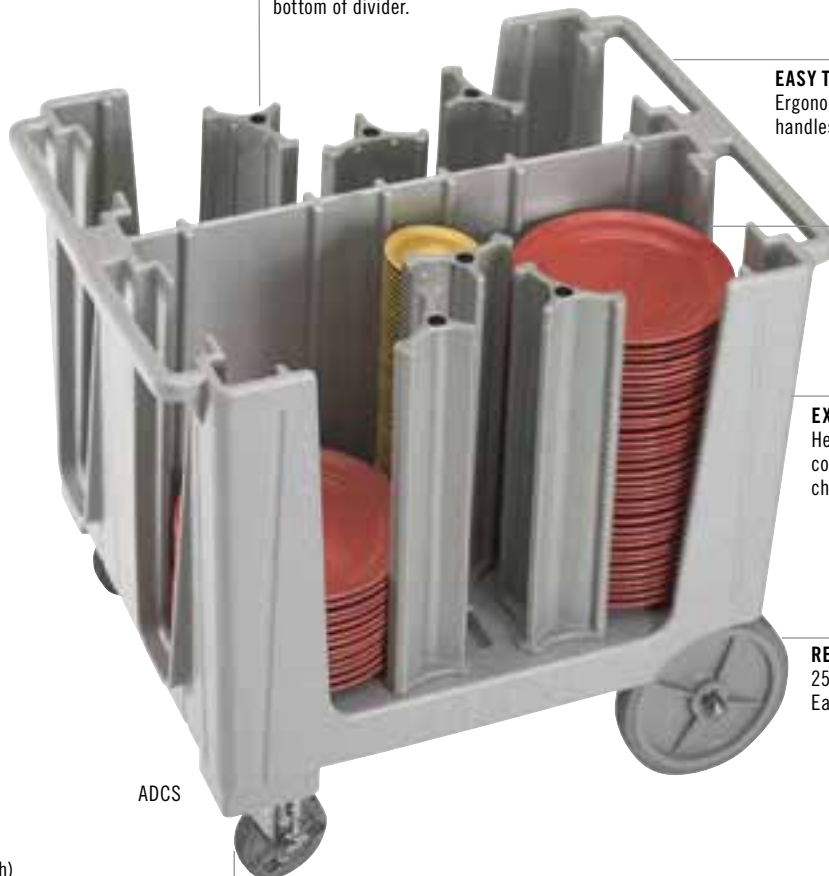

EASY TO MANEUVER

Ergonomic molded-in handles on both ends.

HOLDING CAPACITY

49,5 cm storage columns hold 45-60 plates per stack.

EXTREMELY DURABLE

Heavy duty polyethylene construction protects china from chipping. Won't chip, crack or rust.

REAR WHEELS

25,4 cm non-marking Easy Wheels.

ADCS

FRONT CASTERS

12,7 cm swivel with brake.



A 2 cm plated steel rear axle allows for 227 kg load capacity.



Vinyl cover included with every dolly for sanitary storage.

CODE

NUMBER OF DIVIDERS

ADCS

6

PLATES PER COLUMN

Approximately 45-60

OVERALL DIMENSIONS W x L x H

73 x 96 x 81 cm

Case Pack: 1 Plate size range from 11,7 to 33 cm.

ADC33 ADJUSTABLE DISH CADDY

- Unlimited versatility with fully adjustable tower dividers.
- Safely store plates, bowls, platters and trays of assorted shapes and sizes.
- Ergonomic, durable and easy to maneuver.

ADC33 Colors: Dark Brown (131), Slate Blue (401).

15 cm Casters: 4 swivel with brake and 1 center rigid.

Sanitary vinyl cover included. Cover not NSF listed.



ADC33 is not available from City of Industry, California U.S.A.

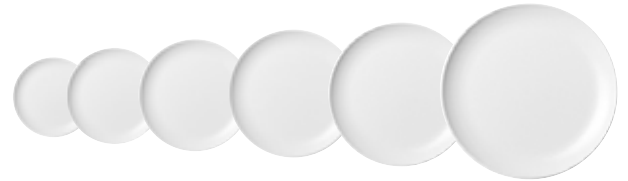

Holds dinnerware from 11 to 33 cm

CODE	ADC33
NUMBER OF DIVIDERS	6
PLATES PER COLUMN	Approximately 45-60
OVERALL DIMENSIONS W x L x H	76,2 x 98,43 x 90,17 cm

Case Pack: 1

Ergonomic handles built flush into either side wall make the ADC33 compact and comfortable to handle.



ADC33

15,24 cm swivel casters with brakes at each corner.

Rigid caster in center of the unit makes maneuvering a breeze, even when fully loaded.

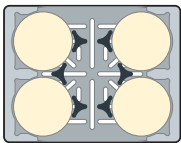

6 Dividers:
4 stacks (11-33 cm) Rounds

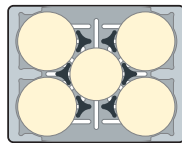

6 Dividers:
4 stacks (11-33 cm) Rounds +
1 stack (17.5-30 cm) Rounds

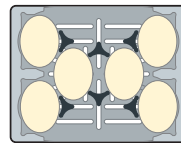

6 Dividers:
6 stacks
(20,3-29,2 x 12,7-21,9 cm) Ovals

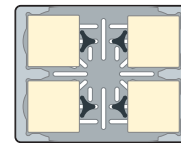

4 Dividers:
4 stacks (25-28,8 cm) Squares

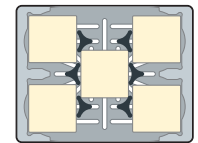

6 Dividers:
5 stacks (24-27,9 cm) Squares

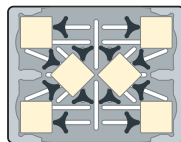

12 Dividers*:
6 stacks (15,2-20,3 cm)
Squares or Rounds

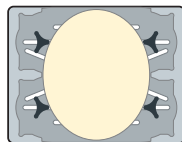

4 Dividers:
1 stack (35-73,6 cm) long x
up to (59,9 cm) wide Oval trays

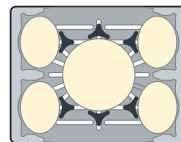

6 Dividers:
4 stacks Ovals
(29,2 x 21,9 cm); 1 stack
40,6 cm Round Tray

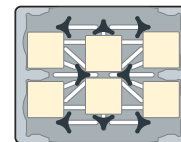

8 Dividers*:
6 stacks (20,3 cm)
Medium Squares

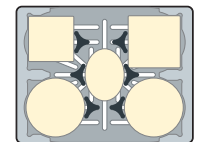

6 Dividers:
2 stacks (33,7 cm) Large Rounds,
1 stack (25,4 cm) Medium Squares,
1 stack (29,2 cm) Large Squares,
1 stack (29,2 x 21,9 cm) Medium
Ovals

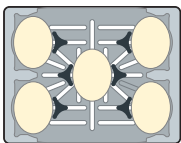

6 Dividers:
5 stacks (29,2 x 21,9 cm) Ovals

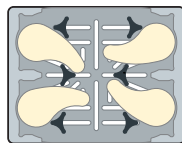

6 Dividers:
4 stacks Custom Plates

VERSA DISH CADDIES™, DISH CADDIES, ADJUSTABLE TRAY & DISH CART

Versa Dish Caddies

- Secure, high-capacity storage to protect both square and round plates.
- Durable, polyethylene exterior will not rust, crack, dent or chip.
- Poker chip style offers greater access for easy plate removal.
- A 2 cm plated steel rear axle allows for 227 kg load capacity.
- Molded-in handles on both ends for easy transporting.
- 12,7 cm front swivel casters with brake and 25,4 cm non-marking rear wheels ease maneuvering.
- No assembly required.

Colors: Black (110), Slate Blue (401), Dark Brown (131), Speckled Grey (480).

Casters: 2, 12,7 cm swivel with brakes and two 25,4 cm Easy Wheels.

Vinyl cover included. Not NSF listed.

DCS950 is covered by U.S. Patent D 603,120S. DCS1125 is covered by U.S. Patent D 625,894.



DCS1125 holds 4 columns of 45-60 round plates up to 28,6 cm or square plates up to 24,1 cm.

DCS950 holds 5 columns of 45-60 round plates up to 24,1 cm or 4 to 5 columns of square plates up to 20,5 cm.

Poker Chip Style Dish Caddies

- Use to store and protect valuable dishware.
- Dividers are molded into the body in a standard poker chip design.
- Made of durable polyethylene that protects plates from chipping.
- Open access from two sides for easy loading and unloading.
- Rounded corners inside and out protect dishware, furniture and walls.

Colors: Black (110), Slate Blue (401), Dark Brown (131), Granite Grey (191).

Casters: 2, 12,7 cm swivel with brakes and two 25,4 cm Easy Wheels.

Vinyl cover included. Not NSF listed.



DC700



Sanitary plastic cover included and recommended for protecting clean dinnerware & trays.

Replacement covers are available through the Cambro Replacement Parts List at www.cambro.com.

Adjustable Tray & Dish Cart

- Use to store a wide variety of plates and trays.
- Move two adjustable dividers into position easily to secure trays and plates.
- Made of durable polyethylene that cushions plates and trays to prevent chipping.
- Easy to clean and won't dent, rust, chip or break.

Colors: Black (110), Slate Blue (401), Coffee Beige (157), Dark Brown (131), Granite Grey (191), Granite Green (192).

Casters: 15,2 cm all swivel, 2 with brake.

Maximum load capacity: 227 kg.

Vinyl cover included. Not NSF listed.



TDC30



Vinyl cover included with every dolly for sanitary storage.



Versa Dish Caddies™

CODE	DCS950	DCS1125
PLATE SIZE RANGE (ROUNDS)	21,3 - 24,1 cm	24,4 - 28,6 cm
PLATE SIZE RANGE (SQUARES)	18,4 - 20,5 cm	21,3 - 24,1 cm
COLUMNS PER CADDY	5, 45-60 plates per col.	4, 45-60 plates per col.
OVERALL DIMENSIONS W x L x H	69 x 78 x 81 cm	69 x 78 x 81 cm

Case Pack: 1

Vinyl cover included with every dolly for sanitary storage.



Poker Chip Style Dish Caddies

CODE	DC575	DC700	DC825
PLATE SIZE RANGE	14,6 cm	14,9 - 17,8 cm	18,1 - 21 cm
COLUMNS PER CADDY	6, 45-60 plates per col.	6, 45-60 plates per col.	4, 45-60 plates per col.
OVERALL DIMENSIONS W x L x H	83 x 60 x 81 cm	83 x 60 x 81 cm	73 x 60,5 x 81,5 cm

Case Pack: 1



Poker Chip Style Dish Caddies

CODE	DC1225
PLATE SIZE RANGE	28,9 - 31,1 cm
COLUMNS PER CADDY	4, 45-60 plates per col.
OVERALL DIMENSIONS W x L x H	83 x 70 x 81,5 cm

Case Pack: 1

Adjustable Tray & Dish Cart



CODE	TDC30
NUMBER OF DIVIDERS	2
PLATES PER COLUMN	Approximately 45-60
TRAYS PER COLUMN	80 Trays: 36 x 46 cm
OVERALL DIMENSIONS W x L x H	59 x 99 x 88 cm
INTERNAL DIMENSIONS W x D	78,7 x 46 cm (no dividers)

Case Pack: 1

CAMBOX® BUSSING BOXES



Regal (ABS)



CODE	1120CBR	1520CBR
DESCRIPTION	Four compartment cutlery box	Cambox
DIM. W x L x H	28,9 x 52 x 9,5 cm	38,9 x 50,6 x 12,5 cm

Case Pack: 12 Colors: Black (110), Dark Brown (131).



CODE	1621CBR	21155CBR	21157CBR	1722CBR
DESCRIPTION	Cambox	Cambox	Cambox	Cambox
DIM. W x L x H	39,7 x 52 x 12,4 cm	38,7 x 51,4 x 12,5 cm (incl. handle)	38,6 x 51,2 x 17,6 cm	42,9 x 55,6 x 12,1 cm

Case Pack: 12 Colors: Black (110), Dark Brown (131).

Polyethylene



CODE	415CBP	912CBP	1120CBP	1520CBP & 1520CBPF*
DESCRIPTION	Cutlery Box	Utility Box	Four compartment cutlery box	Cambox
DIM. W x L x H	11,3 x 36 x 10,3 cm	23 x 30,6 x 13 cm	28,9 x 52 x 9,5 cm	38,9 x 50,6 x 12,5 cm

Case Pack: 12 Colors: Black (110), Dark Brown (131), Light Grey (180). *1520CBPF is identical to our current 1520CBP except the internal surface is flat.



CODE	1621CBP	21155CBP	21157CBP	1722CBP
DESCRIPTION	Cambox	Cambox	Cambox	Cambox
DIM. W x L x H	39,7 x 52 x 12,4 cm	38,7 x 51,4 x 12,5 cm (incl. handle)	38,6 x 51,2 x 17,6 cm	42,9 x 55,6 x 12,1 cm

Case Pack: 12 Colors: Black (110), Dark Brown (131), Light Grey (180).

Box Covers



CODE	1520CBCP	1722CBCP	2115CBCP	2115CBCR
FITS	1520CBP	1722CBR, 1722CBP	21155CBP, 21157CBP	2115CBR, 21157CBR
DIM. W x L	40,6 x 52 cm	44 x 56,8 cm	39,4 x 52 cm	39,4 x 52 cm

Case Pack: 12 Color: White (148).



KD SERVICE CART AND KD UTILITY CART

- Versatile, durable and economically-priced carts.
- Marine rails and lightly-textured polypropylene shelves keep contents in place.
- Aluminum uprights ensure stability.
- Ships “knocked down” to minimize shipping costs.
- Easy to assemble.

Cart and Shelf Panel Set Colors:
Black (110), Speckled Grey (480).

Trash Container and Silverware Holder Color: Black (110).



Each BC340KD shelf holds one full-sized dish rack or two standard bus boxes.

Marine rails keep contents in place.

Optional shelf panels can be added at time of assembly to enclose three sides.

Sturdy aluminum uprights.

Four powder coated steel swivel casters provide quiet transport and steady maneuvering.

BC340KD

Durable, stain-resistant surface is easy to clean.



CODE	BC331KD	BC340KD
DESCRIPTION	Service cart	Large utility cart
CASTER DIA./TYPE	10,2 cm, 4 swivel, no brake	12,7 cm, 4 swivel, no brake
OVERALL DIM. L x D x H	83,5 x 41,3 x 96,5 cm	101,5 x 54 x 95 cm
SHELF DIM. L x D x H	62 x 40 x 30 cm	80 x 52 x 29,8 cm
LOAD CAPACITY	136 kg	180 kg

Case Pack: 1

Shown with optional shelf panels on single shelf.

Optional Accessories



CODE	BC331KDTC	BC331KDSH	BC340KDP
DESCRIPTION	30 L Trash container	9,5 L Silverware holder	Single shelf panel set (for BC340KD only)
DIM. W x D x H	33 x 24 x 56 cm	33 x 24 x 18,5 cm	80,3 x 45 x 29,8 cm

Case Pack: 1

SERVICE CARTS

- All-purpose versatile, durable and dependable workhorses.
- Ideal for use on the receiving dock or setting up and bussing tables.
- Made of one-piece, polyethylene with molded-in handles and shelves.
- Choose from models with open or enclosed sides.

Colors: Black (110), Slate Blue (401), Dark Brown (131), Coffee Beige (157), Granite Grey (191).

BC225, BC2254S, BC11TC and BC1115SH can be shipped by parcel carrier.



Open Carts

CODE	BC225	BC2254S	BC235
CASTER DIA./TYPE	7,6 cm, 2 fixed, 2 swivel, 1 w/brake	7,6 cm, 4 swivel, 1 w/brake	12,7 cm, 2 fixed, 2 swivel, 1 w/brake
OVERALL DIM. L x D x H	71 x 41 x 82 cm	71 x 41 x 82 cm	95 x 55 x 88 cm
SHELF DIM. L x D x H	56 x 39,5 x 29 cm	56 x 39,5 x 29 cm	79 x 52 x 29 cm
LOAD CAPACITY	159 kg	159 kg	227 kg

Case Pack: 1



CODE	BC2354S	BC230	BC2304S
CASTER DIA./TYPE	12,7 cm, 4 swivel, 1 w/brake	12,7 cm, 2 fixed, 2 swivel, 1 w/brake	12,7 cm, 4 swivel, 1 w/brake
OVERALL DIM. L x D x H	95 x 55 x 88 cm	84,5 x 51 x 88 cm	84,5 x 51 x 88 cm
SHELF DIM. L x D x H	79 x 52 x 29 cm	69 x 49,5 x 29 cm	69 x 49,5 x 29 cm
LOAD CAPACITY	227 kg	227 kg	227 kg

Case Pack: 1

Enclosed Carts



CODE	BC330	BC3304S
CASTER DIA./TYPE	12,7 cm, 2 fixed, 2 swivel 1 w/brake	12,7 cm, 4 swivel, 1 w/brake
OVERALL DIM. L x D x H	84,5 x 51 x 88 cm	84,5 x 51 x 88 cm
SHELF DIM. L x D x H	69 x 46,5 x 29 cm	69 x 46,5 x 29 cm
LOAD CAPACITY	227 kg	227 kg

Case Pack: 1

Optional Accessories



CODE	BC11TC*	BC1115SH*
DESCRIPTION	42 L Trash container	6,6 L Silverware holder
DIMENSIONS W x D x H	35 x 20,6 x 53,7 cm	36,8 x 15,2 x 13,7 cm

Case Pack: 1 * BC11TC & BC1115SH will not fit KD Service or Utility Carts. BC11TC & BC1115SH are available in Black (110) and Dark Brown (131) only.



Shelving

- Common and Key Features of Camshelving® Series**
- Camshelving Series Quick Reference Guide**
- Product Code Reference Guide**
- Free Camshelving Design Service**
- Camshelving Series Overall Length – Quick Reference Guide**
- Camshelving Premium Series**
- Premium Series Weight Bearing Chart**
- Premium Series Accessories**
- High Density Storage Floor Track System**
- Camshelving Elements Series**
- Elements Series Weight Bearing Chart**
- Elements Series Accessories**
- Camshelving Basics Series**
- Basics Series Weight Bearing Chart**
- Basics Series Accessories**
- Camshelving Wall Shelves And StoreSafe® Shelf Extenders**
- Dunnage Racks**



Shelving for Life



STORAGE REDEFINED.

With three distinct lines of Camshelving®, all kitchens are created equal!

Every foodservice operation deserves to be set up for maximized cost savings, space efficiency, sanitation, food safety and functionality no matter what the size or budget.

Camshelving storage systems make it all possible, helping foodservice operators optimize organization, support food safety, improve labor savings, simplify inventory management, reduce food waste, and eliminate replacement costs.



Cambro storage and transportation products that help ensure food safety handling.



COMPONENT

Products that meet the NSF International criteria for sanitation and cleanability.



Certifies products approved by Technischer Überwachungs-Verein. (Technical Inspection Association)



Products that help meet HACCP guidelines.



Fit for food products



Dishwasher Safe



Cadmium-free products



Recyclable polypropylene

Camshelving is covered under the following US Patents:

D498,664 S, D508,646 S, D512,867 S, D623,929 S, D624,764 S, D648,582 S, D630,935 S, D648,159 S, D651,433 S, D648,160 S, D697,391 S, D727,715 S, D728,347 S, D728,348 S, D707,994 S, D739,989 S, D663,912 S, D736,488 S, D739,989 S, US 6,981,454B2

camguard
ANTIMICROBIAL SHELF PLATES

Antimicrobial protection permanently molded into shelf plates to inhibit the growth of mold, fungus and bacteria.

CAMSHELVING®

THE COMMON AND KEY FEATURES OF ALL CAMSHELVING SERIES

Rust and Corrosion Free

Backed by a lifetime warranty against rust and corrosion, Camshelving storage systems eliminate the inconvenience and costs associated with restoring or replacing degraded shelving. Only Cambro offers Shelving for Life.



Multi Environment Use

Camshelving storage systems are designed to withstand all extreme storage applications and temperatures — impervious to moisture, chemicals, salt, food acids, and humidity. Camshelving systems can be installed anywhere and will never rust.

-38°C TO 88°C



Maximized Space Utilization

Components have been thoughtfully designed to maximize storage space, even in space-restricted areas.

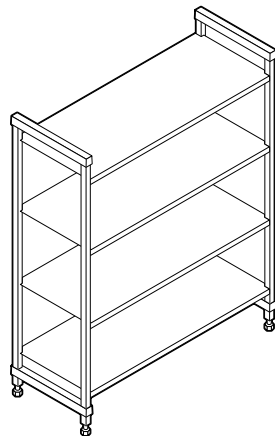

Starter Unit

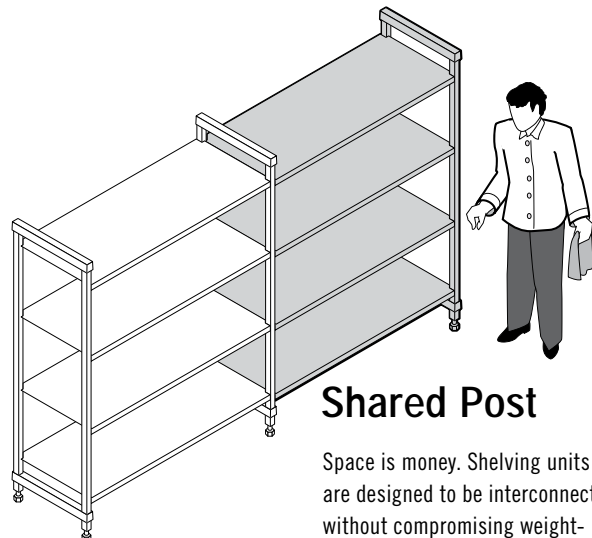

Shared Post

Space is money. Shelving units are designed to be interconnected, without compromising weight-bearing capacity all while maximizing usable storage space.

PREMIUM series

ELEMENTS series

BASICS series

Easy to Clean

Cleaning shelving shouldn't be a major production. Whether daily or scheduled, cleaning can be done quickly and easily without interrupting storage space or normal, day-to-day operations.



Easy to Adjust

Each shelf can be easily and independently adjusted to accommodate a variety of storage products and packages as product and storage needs change.

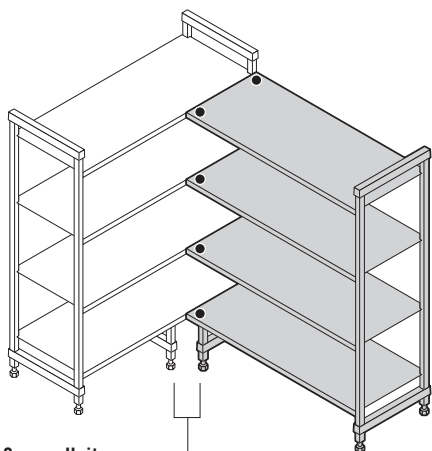

Corner Unit
Starter + Add-On Unit using 1 set of Corner Connectors per shelf and 2 Dunnage Stands.

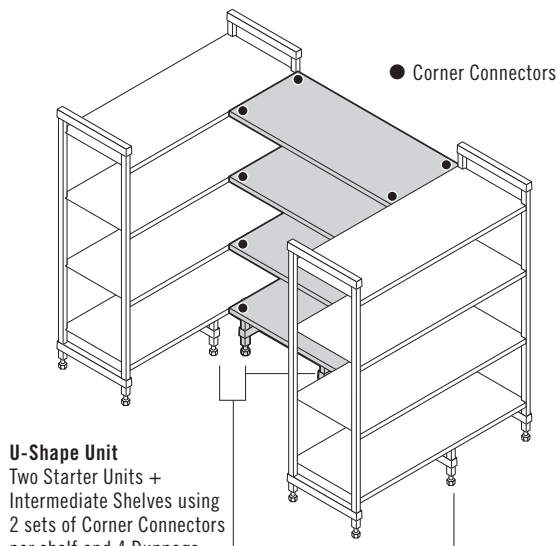

U-Shape Unit
Two Starter Units + Intermediate Shelves using 2 sets of Corner Connectors per shelf and 4 Dunnage Stands.

Corner Shelf Space

Convert unusable space into continuous, easy-access storage areas using corner connectors.

CAMSHELVING® SERIES

QUICK REFERENCE GUIDE

Cambro offers three rust-free, non-corrosive, hygienic shelving systems that will hold up to the tough demands of commercial foodservice operations. This guide will help you choose the ideal Camshelving system for each storage area in your operation. Only Cambro offers Shelving for Life.



camguard
ANTIMICROBIAL SHELF PLATES

PREMIUM series

Storage Areas	High-volume foodservice operations with constant loading and off-loading of heavy products. Frequent and/or multiple daily deliveries. Wet Storage - Walk-in Freezers, Coolers, Warewashing Areas Dry Storage - Bulk Foods, Catering Equipment, China/Dishware, Linen, Merchandising.
Recommended Market Segments	Hotels and Casinos, Restaurants, Quick-Serve Restaurants, Schools, Colleges and Universities, Healthcare, Military, Convention Centers/Stadiums, Cruise Ships, Caterers and Banquet Centers, Corporate Dining, Convenience and Grocery Stores.
Product Material	Posts and traverses are made from a steel core with smooth polypropylene exterior. Superior strength and durable enough to withstand the heaviest loading demands.
Assembly	Molded in dovetails means fewer parts, making it the easiest to assemble.
Weight-Bearing Capacity (based on 610 - 1220 mm length)	Stationary Unit: 363 kg per shelf, 1451 kg per unit. Mobile Unit: 340 kg per unit. Corner and U-Shape Unit: 181 kg per shelf, 726 kg per unit.
Lifetime Warranty Against Rust & Corrosion	Shelf Plates, Posts and Traverses
Shelf Lengths	610, 765, 915, 1070, 1220, 1375, 1525, 1830 mm
Shelf Depths	360, 460, 540, 610 mm
Post Heights	Stationary: 820, 1430, 1630, 1830, 2140 mm Mobile: 890, 1500, 1700, 1910 mm (includes casters)
Mobile Units	YES
High Density Storage Floor Track System	YES
Bottom Shelf Dunnage Stand	YES
Shelf Rails	YES
Vertical Drying and Storage Cradle (Trays / Cutting Boards / Lids)	YES
Dome Drying and Storage Cradle	YES
Angled Drying and Storage Cradle	YES
Shelf Divider (Narrow Item Storage)	YES
Shelf Divider Bar (for Food Pans or Food Boxes)	YES
Tray Sliding Rack	YES
Single Shelf Security Cage	YES
Full Wrap Security Cage	YES

ACCESSORIES



ELEMENTS series

BASICS series

High-volume foodservice operations with constant loading and off-loading of medium to heavy products. 5-7 deliveries per week.

Wet Storage - Walk-in Freezers, Coolers, Warewashing Areas

Dry Storage - Bulk Foods, Catering Equipment, China/Dishware, Linen, Merchandising.

Medium-volume foodservice operations with constant loading and off-loading of light to medium products. 2-5 deliveries per week.

Wet Storage - Walk-in Freezers, Coolers, Warewashing Areas

Dry Storage - Bulk Foods, Catering Equipment, China/Dishware, Linen, Merchandising, and Disposables.

Hotels and Casinos, Restaurants, Quick-Serve Restaurants, Schools, Colleges and Universities, Healthcare, Military, Convention Centers/Stadiums, Cruise Ships, Caterers and Banquet Centers, Corporate Dining, Convenience and Grocery Stores.

Hotels and Casinos, Restaurants, Quick-Serve Restaurants, Schools, Colleges and Universities, Healthcare, Convention Centers/Stadiums, Caterers and Banquet Centers, Corporate Dining, Convenience Stores, Yogurt Shops and Cafés.

Posts and traverses are made from a revolutionary composite material that is light in weight yet strong enough to withstand rigorous loading conditions.

Posts and traverses are made from the same revolutionary composite material as Elements Series. Slim design is lighter in weight, yet durable and strong enough to withstand a wide variety of storage conditions.

Easy to assemble.

Easy to assemble.

Stationary Unit: 363 kg per shelf, 1451 kg per unit.
Mobile Unit: 340 kg per unit.
Corner and U-Shape Unit: 181 kg per shelf, 726 kg per unit.

Stationary Unit: 272 kg per shelf, 998 kg per unit.
Corner and U-Shape Unit: 136 kg per shelf, 544 kg per unit.

Shelf Plates, Posts and Traverses

Shelf Plates, Posts and Traverses

610, 765, 915, 1070, 1220, 1375, 1525, 1830 mm

765, 915, 1070, 1220, 1375, 1525 mm

360, 460, 540, 610 mm

460, 540, 610 mm

Stationary: 1630, 1830, 2140 mm
Mobile: 1778, 1980 mm (includes casters)

Stationary: 1630, 1830, 2140 mm

YES

NO

NO

NO

YES

YES

NO

NO

YES

YES

YES

YES

YES

YES

YES

YES

YES

NO

YES

YES

YES

YES

NO

NO

PRODUCT CODE REFERENCE GUIDE

Cambro's new product codes have been simplified making it easier to identify the type of unit or accessory required. Code numbers are composed of 3 parts.

1. **Prefix** – Defines the shelving brand and type and of unit being selected.
2. **Dimensions** – Identifies the depth, length and height.
3. **Suffix** – Type and quantity of shelves.

Complete Units

CP Camshelving® Premium Series

- CPU Stationary Starter Unit
- CPA Stationary Add-On Unit
- CPMU Mobile Unit
- CPHU High Density Mobile Unit

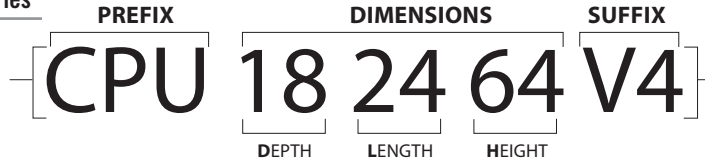

E Camshelving Elements Series

- ESU Stationary Starter Unit
- EA Stationary Add-On Unit
- EMU Mobile Unit

CB Camshelving Basics Series

- CBU Stationary Starter Unit
- CBA Stationary Add-On Unit

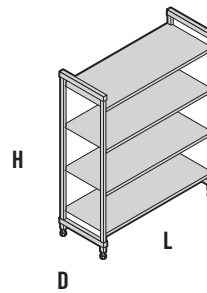

V4 4 Vented Shelves

V5 5 Vented Shelves

S4 4 Solid Shelves

S5 5 Solid Shelves

VS4 3 Vented Shelves + 1 Solid Shelf

VS5 4 Vented Shelves + 1 Solid Shelf

V4PKG* 4 Vented Shelves

V5PKG* 5 Vented Shelves

S4PKG* 4 Solid Shelves

S5PKG* 5 Solid Shelves

VS4PKG* 3 Vented Shelves + 1 Solid Shelf

VS5PKG* 4 Vented Shelves + 1 Solid Shelf

* Premium Series only - 2140 mm high units and 1830 mm long units, all heights.

Post Kits and Shelf Kits

CP Camshelving Premium Series

- CPSK Stationary Shelf Kit
- CPPK Stationary Post Kit
- CPMPK Mobile Post Kit

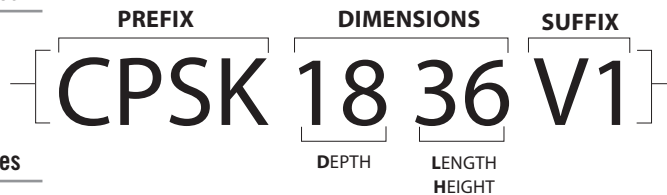

E Camshelving Elements Series

- ESK Stationary Shelf Kit
- EPK Stationary Post Kit
- EMSK Mobile Shelf Kit
- EMPK Mobile Post Kit

CB Camshelving Basics Series

- CBSK Stationary Shelf Kit
- CBPK Stationary Post Kit

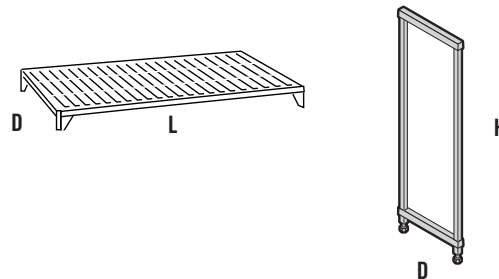

V1 1 Vented Shelf

S1 1 Solid Shelf

V4 4 Vented Shelves

V5 5 Vented Shelves

S4 4 Solid Shelves

S5 5 Solid Shelves

VS4 3 Vented Shelves + 1 Solid Shelf

VS5 4 Vented Shelves + 1 Solid Shelf

Accessories

If an accessory is used by more than 1 line of shelving, the code will start with CS.

If an accessory is only used in one line of shelving, the code will start by the prefix letters of the line.

Example: Corner Connectors:

- a. CPCC1 = Camshelving Premium Corner Connector Set
- b. ECC1 = Camshelving Elements Corner Connector Set
- c. CBCC1 = Camshelving Basics Corner Connector Set

FREE CAMSHELVING® DESIGN SERVICE

In order to select the most suitable and cost effective storage system, Cambro offers customized shelving illustrations using our proprietary shelving design program. Space allocation, operational flow and organizational challenges are quickly addressed when selecting the right product for the storage application. Usable storage space is maximized using the least number of units to help operators manage equipment costs.

Once all required information is received, our expert shelving consultants prepare a 2D and 3D recommended floor plan along with an itemized product list by room/area. Proposals are completed and emailed within 24-48 business day hours, depending on number of rooms and complexity. We look forward to designing the perfect storage solution for you. Call or email today to connect with one of our Camshelving consultants.

CAMBRO USA: 1(714) 230-4113
shelving@cambro.com

CAMBRO EUROPEAN LOGISTICS: (49)7022 90 100 0
cambroeuropa@cambro.co

It's Simple! To Get Started, Please Provide:

- Project Name
- Storage Room Type (freezer / cooler)
- Room(s) Dimensions (L x W x H)
- Doorway / Entryway Location & Dimension
- Obstructions (condenser / pipes)
- Additional Preferences / Requirements

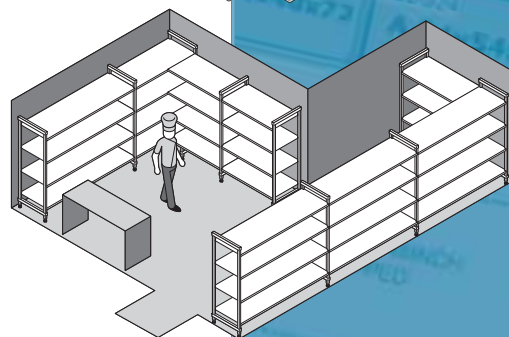
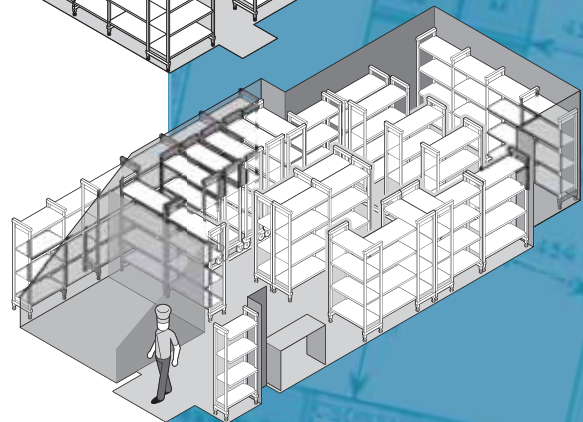
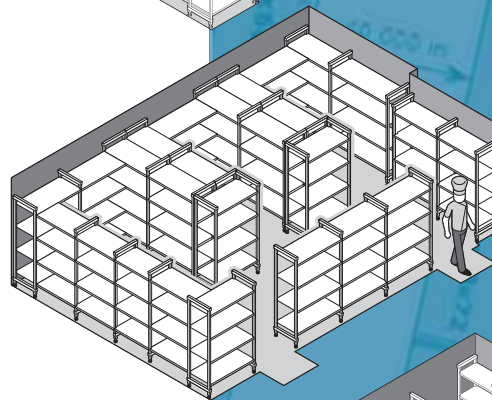
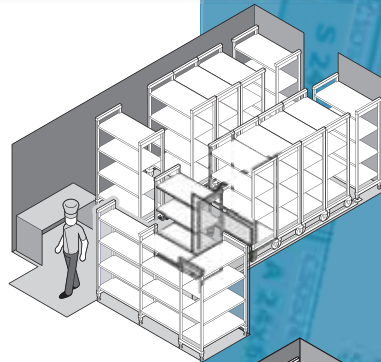
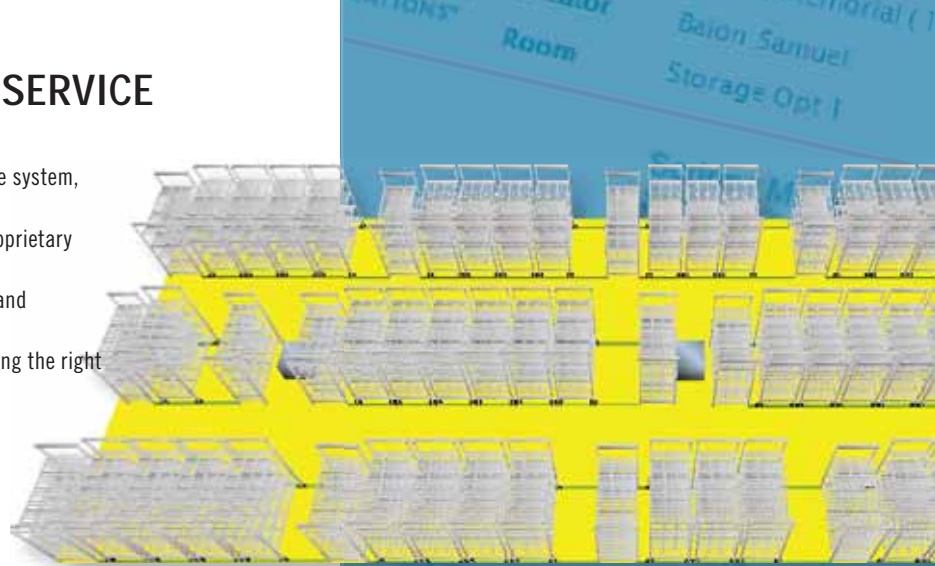

CAMSHELVING® SERIES OVERALL LENGTH – QUICK REFERENCE GUIDE

Straight Unit: Starter Unit + Add-On Unit with Shared Posts

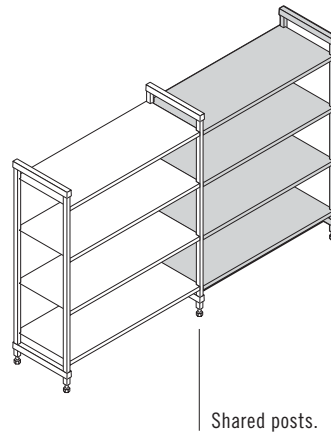
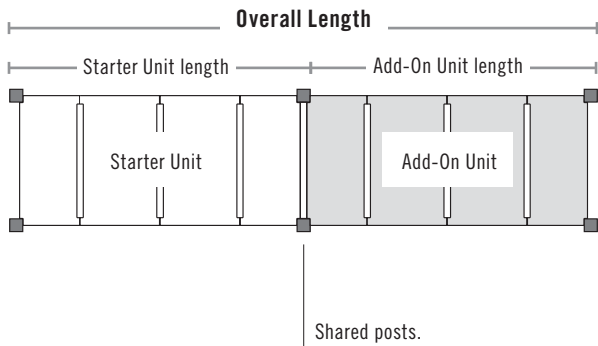

Corner Unit: Starter Unit + Add-On Unit with Corner Connectors

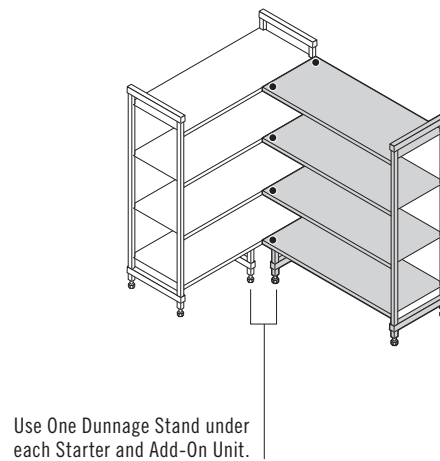
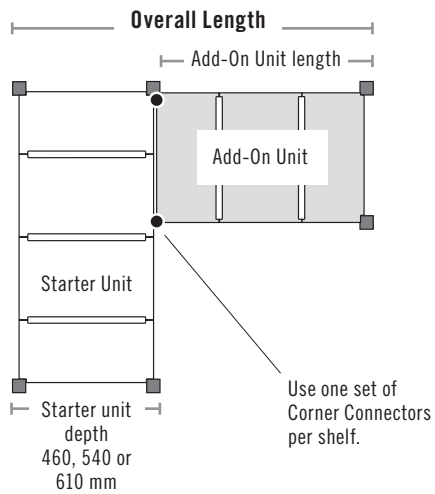

U-Shape Unit: Two Starter Units + Intermediate Shelves with Corner Connectors

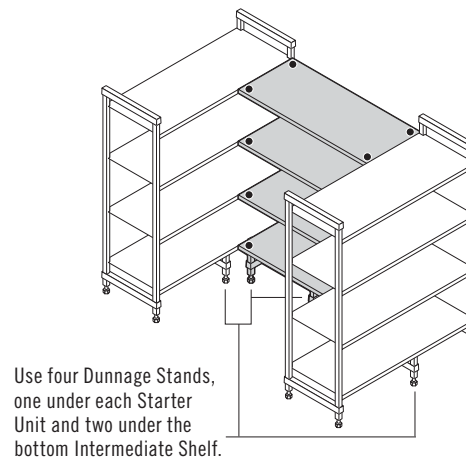
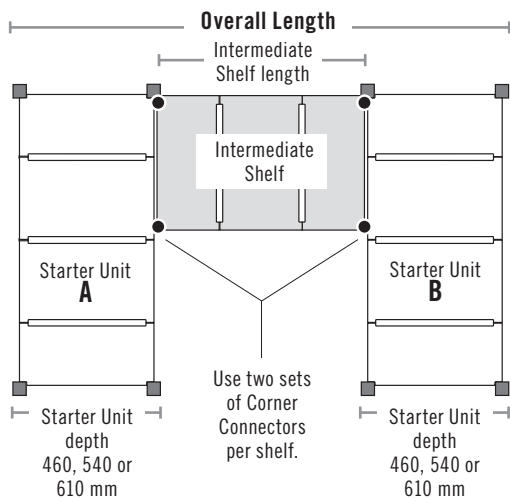

Straight Unit: Starter Unit + Add-On Unit with Shared Posts

PREMIUM / BASICS SERIES				
STARTER UNIT ACTUAL LENGTH		ADD-ON UNIT ACTUAL LENGTH	=	OVERALL LENGTH
610 mm	+	566 mm	=	1176 mm
765	+	718	=	1483
915	+	870	=	1785
1070	+	1023	=	2093
1220	+	1175	=	2395
1375	+	1328	=	2703
1525	+	1480	=	3005
1830	+	1785	=	3615

610 and 1830 are not available in Camshelving Basics Series.

ELEMENTS SERIES				
STARTER UNIT ACTUAL LENGTH		ADD-ON UNIT ACTUAL LENGTH	=	OVERALL LENGTH
610 mm	+	559 mm	=	1169 mm
765	+	712	=	1477
915	+	864	=	1779
1070	+	1016	=	2086
1220	+	1169	=	2389
1375	+	1321	=	2696
1525	+	1474	=	2999
1830	+	1778	=	3608

Corner Unit: Starter Unit + Add-On Unit with Corner Connectors

PREMIUM / ELEMENTS / BASICS SERIES					PREMIUM / ELEMENTS / BASICS SERIES					PREMIUM / ELEMENTS / BASICS SERIES				
ADD-ON UNIT	ADD-ON UNIT ACTUAL LENGTH		460 MM STARTER UNIT DEPTH	OVERALL LENGTH	ADD-ON UNIT ACTUAL LENGTH		540 MM STARTER UNIT DEPTH	OVERALL LENGTH	ADD-ON UNIT ACTUAL LENGTH		610 MM STARTER UNIT DEPTH	OVERALL LENGTH		
610 mm	585 mm	+	*458 mm	= 1043 mm	585 mm	+	*534 mm	= 1119 mm	585 mm	+	*610 mm	= 1195 mm		
765	737	+	458	= 1195	737	+	534	= 1271	737	+	610	= 1347		
915	889	+	458	= 1347	889	+	534	= 1423	889	+	610	= 1499		
1070	1042	+	458	= 1500	1042	+	534	= 1576	1042	+	610	= 1652		
1220	1194	+	458	= 1652	1194	+	534	= 1728	1194	+	610	= 1804		

610 mm unit not available in Camshelving Basics Series.

* Actual depth.

U-Shape Unit: Two Starter Units + Intermediate Shelves with Corner Connectors

PREMIUM / ELEMENTS / BASICS SERIES					PREMIUM / ELEMENTS / BASICS SERIES					PREMIUM / ELEMENTS / BASICS SERIES				
INTERMEDIATE SHELF	INTERMEDIATE SHELF ACTUAL LENGTH		460 MM DEPTH STARTER UNIT A+B	OVERALL LENGTH	INTERMEDIATE SHELF ACTUAL LENGTH		540 MM DEPTH STARTER UNIT A+B	OVERALL LENGTH	INTERMEDIATE SHELF ACTUAL LENGTH		610 MM DEPTH STARTER UNIT A+B	OVERALL LENGTH		
915 mm	864 mm	+	*915 mm	= 1779 mm	864 mm	+	*1067 mm	= 1945 mm	864 mm	+	*1220 mm	= 2084 mm		
1070	1016	+	915	= 1931	1016	+	1067	= 2100	1016	+	1220	= 2236		
1220	1169	+	915	= 2084	1169	+	1067	= 2250	1169	+	1220	= 2389		

* Actual depth.

CAMSHELVING® PREMIUM series

WHY CHOOSE PREMIUM?

In high volume foodservice operations with frequent deliveries and constant loading and off-loading of products, stability, strength and sanitary storage should never be compromised. Premium Series does precisely what it was designed to do – hold the heaviest products with the roughest handling, in any environment and it is the easiest to clean and adjust.



All Environments
-38°C TO 88°C

Stationary

High Density

Mobile

camguard
ANTIMICROBIAL SHELF PLATES



storage needs
HEAVY

daily deliveries
FREQUENT

Post Connectors, Corner Connectors, Seismic Foot, Wall Fastener, Identification Tags, Full Wrap Security Cage, Single Shelf Security Cage, Tray Slide Rack, Shelf Rails, Shelf Divider Bars, High Density Track and Extension Kits are not NSF Listed.

CAMSHELVING® PREMIUM SERIES
STATIONARY UNIT SIZES

MOBILE UNIT SIZES

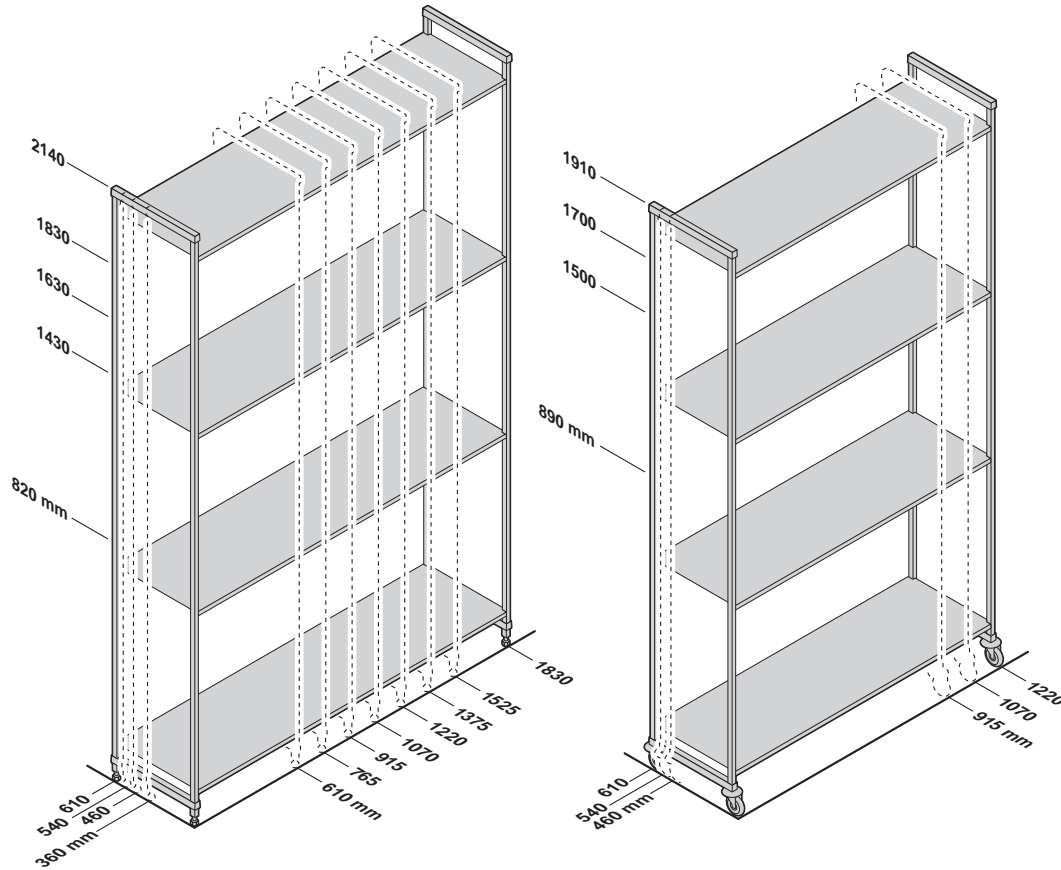

4 SHELF UNIT WEIGHT BEARING CHART

Single Unit

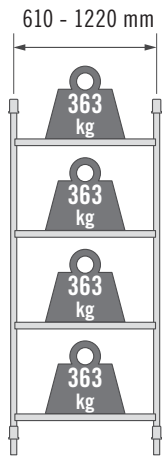

1451 kg
Maximum
Unit Capacity

Single Unit

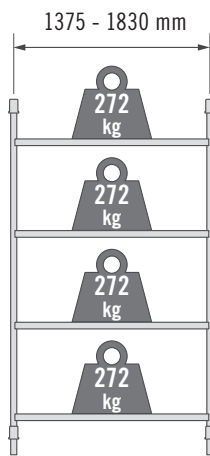

1089 kg
Maximum
Unit Capacity

Single Unit with
Dunnage Stand

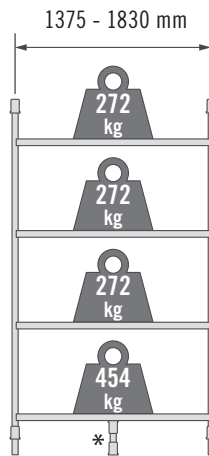

1270 kg
Maximum
Unit Capacity

Corner Unit with
2 Dunnage Stands

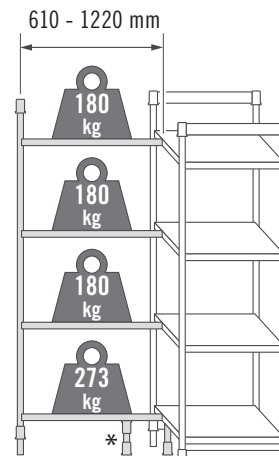

813 kg
Maximum
Unit Capacity

Mobile Unit

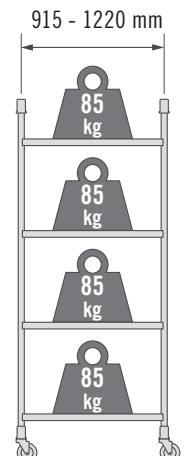

340 kg**
Maximum
Unit Capacity

* Dunnage Stands add stability and increase weight bearing capacity on bottom shelf only. Add to any shelf length. Highly recommended for Starter Units 1375 mm and longer, all Corner Units, U-Shape Units and units specified for heavier loads (see page 92).

** Due to the weight bearing capacity of casters, maximum weight load on an entire Mobile Unit is 340 kg.

CAMSHELVING® PREMIUM SERIES

Starter, Add-On and Mobile Units

These units make ordering easy and save time and labor during installation. Units ship complete in one box.* Post kits are pre-assembled at the factory, speeding up on site set up.

* Due to unit weight and size, all 2140 mm high units and 1830 mm long units, all heights, ship in multiple boxes of post kits (unassembled) and shelf kits.





4-Shelf Vented Stationary Starter and Add-On Units

Starter units include 2 factory assembled post kits and shelves.

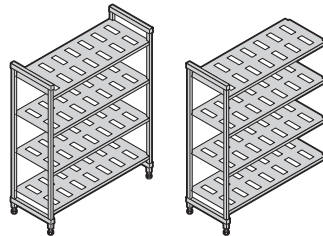
Add-On units include 1 factory assembled post kit and shelves.



1630 and 1830 mm units ship in  1

1830 long and 2140 mm high Add-on units ship in  2

1830 long and 2140 mm high Starter units ship in  3

HEIGHTS	DEPTHS	LENGTHS	
3	3	8	
1630 mm	460 mm	610 mm	1220 mm
1830	540	765	1375
2140	610	915	1525
		1070	1830

4-Shelf Solid Stationary Starter and Add-On Units

Starter units include 2 factory assembled post kits and shelves.

Add-On units include 1 factory assembled post kit and shelves.

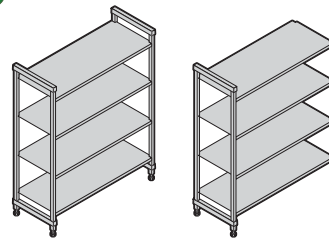

1630 and 1830 mm units ship in  1

1830 long and 2140 mm high Add-on units ship in  2

1830 long and 2140 mm high Starter units ship in  3

HEIGHTS	DEPTHS	LENGTHS	
3	3	8	
1630 mm	460 mm	610 mm	1220 mm
1830	540	765	1375
2140	610	915	1525
		1070	1830

4-Shelf Vented and Solid Stationary Starter and Add-On Units (3 vented + 1 solid)

Starter units include 2 factory assembled post kits and shelves.

Add-On units include 1 factory assembled post kit and shelves.

Install solid shelf on bottom to prevent water/cleaning solutions from sloshing up onto stored products. Install solid shelf on top to protect product stored on lower shelves from condensation in cooler.

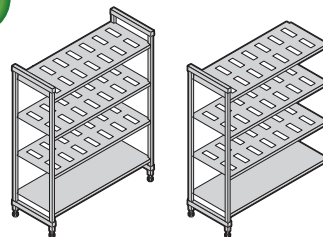

1630 and 1830 mm units ship in  1

1830 long and 2140 mm high Add-on units ship in  2

1830 long and 2140 mm high Starter units ship in  3

HEIGHTS	DEPTHS	LENGTHS	
3	3	8	
1630 mm	460 mm	610 mm	1220 mm
1830	540	765	1375
2140	610	915	1525
		1070	1830

5-Shelf Vented Stationary Starter and Add-On Units

Starter units include 2 factory assembled post kits and shelves.

Add-On units include 1 factory assembled post kit and shelves.

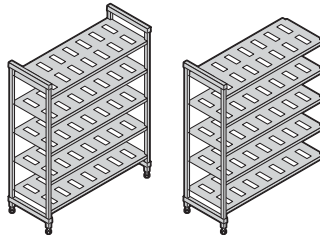

1630 and 1830 mm units ship in  1

HEIGHTS	DEPTHS	LENGTHS
3	3	8
1630 mm	460 mm	610 mm 1220 mm
1830	540	765 1375
2140	610	915 1525
		1070 1830

1830 long and 2140 mm high Add-on units ship in  2

1830 long and 2140 mm high Starter units ship in  3

5-Shelf Solid Stationary Starter and Add-On Units

Starter units include 2 factory assembled post kits and shelves.

Add-On units include 1 factory assembled post kit and shelves.

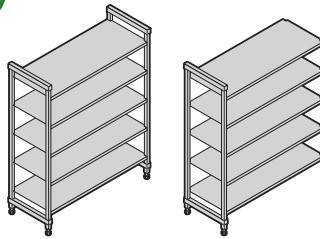

2140 mm Add-on units ship in  2

2140 mm Starter units ship in  3

HEIGHT	DEPTHS	LENGTHS
1	3	8
2140 mm	460 mm	610 mm 1220 mm
	540	765 1375
	610	915 1525
		1070 1830

5-Shelf Vented and Solid Stationary Starter And Add-On Units (4 vented + 1 solid)

Starter units include 2 factory assembled post kits and shelves.

Add-On units include 1 factory assembled post kit and shelves.

Install solid shelf on bottom to prevent water/cleaning solutions from sloshing up onto stored products. Install solid shelf on top to protect product stored on lower shelves from condensation in cooler.

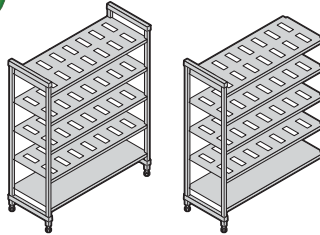

2140 mm Add-on units ship in  2

2140 mm Starter units ship in  3

HEIGHT	DEPTHS	LENGTHS
1	3	8
2140 mm	460 mm	610 mm 1220 mm
	540	765 1375
	610	915 1525
		1070 1830

4 or 5-Shelf Vented Mobile Starter Units

Mobile starter units include 2 factory assembled mobile post kits, shelves and 4 premium swivel casters with total locking brake.

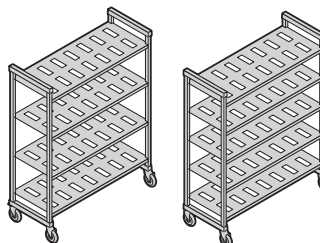

HEIGHTS*	DEPTHS	LENGTHS
2	3	3
1700 mm	460 mm	915 mm
1910	540	1070
	610	1220

* Includes 127 mm casters.

Ships in  1



Visit the Camshelving Microsite at www.cambro.com/camshelving for product information and pricing on all available shelving products. View or download the Camshelving Specification and Price List. Or scan QR code.

PREMIUM
SERIES

V4

4-SHELF VENTED UNITS

1630
mm
HEIGHT

Starter units include 2 factory assembled post kits and shelves. Add-on units include 1 factory assembled post kit and shelves. Units ship complete in 1 box.

Starter

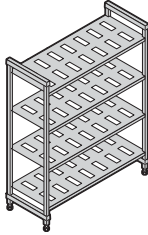

Add-On

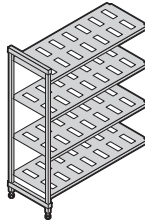

460 mm
DEPTH

DIMENSIONS
D x L x H

460 x 610 x 1630 mm
460 x 765 x 1630
460 x 915 x 1630
460 x 1070 x 1630
460 x 1220 x 1630
460 x 1375 x 1630
460 x 1525 x 1630
460 x 1830 x 1630

CODE

CPU182464V4
CPU183064V4
CPU183664V4
CPU184264V4
CPU184864V4
CPU185464V4
CPU186064V4
CPU187264V4PKG

CODE

CPA182464V4
CPA183064V4
CPA183664V4
CPA184264V4
CPA184864V4
CPA185464V4
CPA186064V4
CPA187264V4PKG

PKG units ship same as 2140 mm units.

540 mm
DEPTH

540 x 610 x 1630 mm
540 x 765 x 1630
540 x 915 x 1630
540 x 1070 x 1630
540 x 1220 x 1630
540 x 1375 x 1630
540 x 1525 x 1630
540 x 1830 x 1630

CPU212464V4
CPU213064V4
CPU213664V4
CPU214264V4
CPU214864V4
CPU215464V4
CPU216064V4
CPU217264V4PKG

CPA212464V4
CPA213064V4
CPA213664V4
CPA214264V4
CPA214864V4
CPA215464V4
CPA216064V4
CPA217264V4PKG

PKG units ship same as 2140 mm units.

610 mm
DEPTH

610 x 610 x 1630 mm
610 x 765 x 1630
610 x 915 x 1630
610 x 1070 x 1630
610 x 1220 x 1630
540 x 1375 x 1630
610 x 1525 x 1630
610 x 1830 x 1630

CPU242464V4
CPU243064V4
CPU243664V4
CPU244264V4
CPU244864V4
CPU245464V4
CPU246064V4
CPU247264V4PKG

CPA242464V4
CPA243064V4
CPA243664V4
CPA244264V4
CPA244864V4
CPA245464V4
CPA246064V4
CPA247264V4PKG

PKG units ship same as 2140 mm units.

PREMIUM
SERIES

V4

4-SHELF VENTED UNITS

1830
mm
HEIGHT

Starter units include 2 factory assembled post kits and shelves. Add-on units include 1 factory assembled post kit and shelves. Units ship complete in 1 box.

Starter

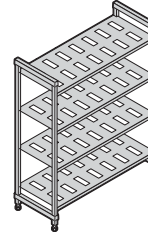

Add-On

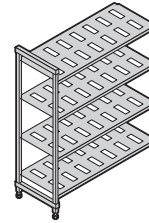

DIMENSIONS
D x L x H

460 x 610 x 1830 mm
460 x 765 x 1830
460 x 915 x 1830
460 x 1070 x 1830
460 x 1220 x 1830
460 x 1375 x 1830
460 x 1525 x 1830
460 x 1830 x 1830

CODE

CPU182472V4
CPU183072V4
CPU183672V4
CPU184272V4
CPU184872V4
CPU185472V4
CPU186072V4
CPU187272V4PKG

CODE

CPA182472V4
CPA183072V4
CPA183672V4
CPA184272V4
CPA184872V4
CPA185472V4
CPA186072V4
CPA187272V4PKG

540 x 610 x 1830 mm
540 x 765 x 1830
540 x 915 x 1830
540 x 1070 x 1830
540 x 1220 x 1830
540 x 1375 x 1830
540 x 1525 x 1830
540 x 1830 x 1830

CPU212472V4
CPU213072V4
CPU213672V4
CPU214272V4
CPU214872V4
CPU215472V4
CPU216072V4
CPU217272V4PKG

CPA212472V4
CPA213072V4
CPA213672V4
CPA214272V4
CPA214872V4
CPA215472V4
CPA216072V4
CPA217272V4PKG

610 x 610 x 1830 mm
610 x 765 x 1830
610 x 915 x 1830
610 x 1070 x 1830
610 x 1220 x 1830
540 x 1375 x 1830
610 x 1525 x 1830
610 x 1830 x 1830

CPU242472V4
CPU243072V4
CPU243672V4
CPU244272V4
CPU244872V4
CPU245472V4
CPU246072V4
CPU247272V4PKG

CPA242472V4
CPA243072V4
CPA243672V4
CPA244272V4
CPA244872V4
CPA245472V4
CPA246072V4
CPA247272V4PKG

Color: Speckled Grey (480).

PREMIUM
SERIES

2140
mm
HEIGHT

V5PKG 5-SHELF VENTED UNITS

Due to the unit weight, 2140 mm units ship in separate boxes. Starter units include 2 post kits and 1 box of shelves. Add on units include 1 post kit and 1 box of shelves. Post kits require assembly.

Starter

Add-On

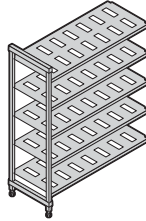
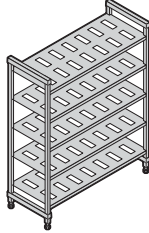

460 mm
DEPTH

DIMENSIONS
D x L x H

460 x 610 x 2140 mm
460 x 765 x 2140
460 x 915 x 2140
460 x 1070 x 2140
460 x 1220 x 2140
460 x 1375 x 2140
460 x 1525 x 2140
460 x 1830 x 2140

CODE

CPU182484V5PKG
CPU183084V5PKG
CPU183684V5PKG
CPU184284V5PKG
CPU184884V5PKG
CPU185484V5PKG
CPU186084V5PKG
CPU187284V5PKG

CODE

CPA182484V5PKG
CPA183084V5PKG
CPA183684V5PKG
CPA184284V5PKG
CPA184884V5PKG
CPA185484V5PKG
CPA186084V5PKG
CPA187284V5PKG

540 mm
DEPTH

540 x 610 x 2140 mm
540 x 765 x 2140
540 x 915 x 2140
540 x 1070 x 2140
540 x 1220 x 2140
540 x 1375 x 2140
540 x 1525 x 2140
540 x 1830 x 2140

CPU212484V5PKG
CPU213084V5PKG
CPU213684V5PKG
CPU214284V5PKG
CPU214884V5PKG
CPU215484V5PKG
CPU216084V5PKG
CPU217284V5PKG

CPA212484V5PKG
CPA213084V5PKG
CPA213684V5PKG
CPA214284V5PKG
CPA214884V5PKG
CPA215484V5PKG
CPA216084V5PKG
CPA217284V5PKG

610 mm
DEPTH

610 x 610 x 2140 mm
610 x 765 x 2140
610 x 915 x 2140
610 x 1070 x 2140
610 x 1220 x 2140
610 x 1375 x 2140
610 x 1525 x 2140
610 x 1830 x 2140

CPU242484V5PKG
CPU243084V5PKG
CPU243684V5PKG
CPU244284V5PKG
CPU244884V5PKG
CPU245484V5PKG
CPU246084V5PKG
CPU247284V5PKG

CPA242484V5PKG
CPA243084V5PKG
CPA243684V5PKG
CPA244284V5PKG
CPA244884V5PKG
CPA245484V5PKG
CPA246084V5PKG
CPA247284V5PKG

Color: Speckled Grey (480).

PREMIUM
SERIES

1700
mm
HEIGHT

460 mm
DEPTH

540 mm
DEPTH

610 mm
DEPTH

1910
mm
HEIGHT

460 mm
DEPTH

540 mm
DEPTH

610 mm
DEPTH

V4

4-SHELF VENTED MOBILE UNITS

Mobile starter units include 2 factory assembled mobile post kits, shelves and 4 premium swivel casters with total locking brake. Units ship complete in 1 box.

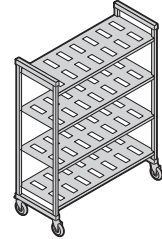

CODE **DIMENSIONS**
D x L x H*

CPMU183667V4	460 x 915 x 1700 mm
CPMU184267V4	460 x 1070 x 1700
CPMU184867V4	460 x 1220 x 1700

CPMU213667V4	540 x 915 x 1700 mm
CPMU214267V4	540 x 1070 x 1700
CPMU214867V4	540 x 1220 x 1700

CPMU243667V4	610 x 915 x 1700 mm
CPMU244267V4	610 x 1070 x 1700
CPMU244867V4	610 x 1220 x 1700

CODE **DIMENSIONS**
D x L x H*

CPMU183675V4	460 x 915 x 1910 mm
CPMU184275V4	460 x 1070 x 1910
CPMU184875V4	460 x 1220 x 1910

CPMU213675V4	540 x 915 x 1910 mm
CPMU214275V4	540 x 1070 x 1910
CPMU214875V4	540 x 1220 x 1910

CPMU243675V4	610 x 915 x 1910 mm
CPMU244275V4	610 x 1070 x 1910
CPMU244875V4	610 x 1220 x 1910

* Includes 127 mm casters.



CAMSHELVING® PREMIUM SERIES ACCESSORIES

Bottom Shelf Dunnage Stands

Increase weight bearing capacity on bottom shelf only. Add to any shelf length. Highly recommended for starter units 1375 mm and longer and all corner units, intermediate units and units specified for heavier load volume on and off bottom shelves.

CODE	DIMENSIONS D x H*	
Dunnage Stand – Low		
CPDS14H6	360 x 190 mm	
CPDS18H6	460 x 190	
CPDS21H6	540 x 190	
CPDS24H6	610 x 190	
Dunnage Stand – Tall		
New! CPDS14H11	360 x 289	
New! CPDS18H11	460 x 289	
New! CPDS21H11	540 x 289	
New! CPDS24H11	610 x 289	
Case Pack: 1		
Color: Speckled Grey (480).		

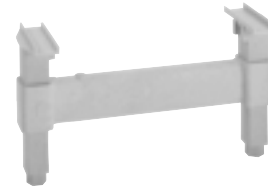
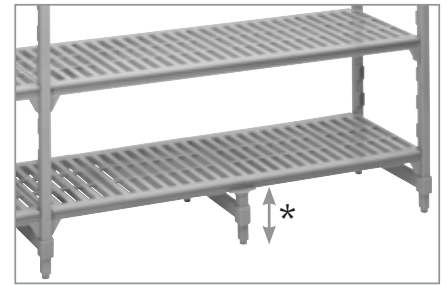

Corner Connectors

Unique patented design ensures maximum shelf space utilization. Use 1 set per shelf to connect starter and add-on units in corners. Connect 4 or 5 intermediate shelves between 2 starter units (2 sets required per shelf). Available as a single set or 8 or 10 set packs.

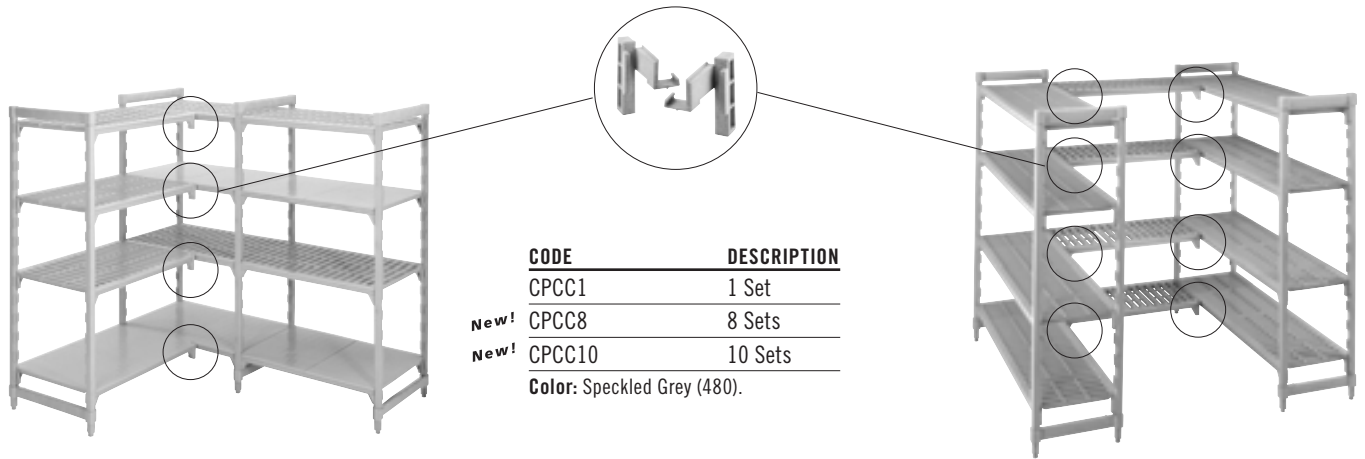

CODE	DESCRIPTION
CPCC1	1 Set
New! CPCC8	8 Sets
New! CPCC10	10 Sets
Color: Speckled Grey (480).	

Identification Tags

Clip onto shelf traverses to clearly identify stored product. Made of highly durable plastic with a clear slide in front panel. Labels included.

CODE	DESCRIPTION	DIMENSIONS L x H
CSID6	152 mm ID Tag	152 x 25 mm
CSID3	76 mm ID Tag	76 x 25
Case Pack: 12 Color: White / Clear.		



Wall Fastener

Use to secure stationary shelving unit to a wall for added safety and stability where required. Made of stainless steel. Screws not included.

CODE	DIMENSION D x L x H
CSWF	73 x 238 x 48 mm
Case Pack: 4 Color: Silver (000).	



Hole diameter 1,11 cm.



CAMSHELVING® PREMIUM SERIES ACCESSORIES

Seismic Foot

Secure stationary unit posts directly to the floor for added safety and stability where required. Made of stainless steel. Bolts not included.

CODE	DIMENSION D x L x H
CSEQ3	102 x 83 x 59 mm
Case Pack: 4 Color: Silver (000).	



Hole diameter 1,43 cm.



Premium Caster

Ideal in all areas of storage, especially coolers, freezers and/or wet areas. Made of highly durable, non-corrosive plastic with a 127 mm swivel, non-marking thermoplastic rubber wheel. Total locking brake locks both swivel motion and the wheel.

CODE	SIZE
CPMCWB	127 mm
Case Pack: 2 Color: Grey (000).	



Donut Bumper

Offers added protection during transport and when maneuvering mobile units into place against walls or alongside other units for storage.

CODE	DIAMETER
CSRDB	90 mm
Case Pack: 4 Color: Grey (000).	



Shelf Divider

Stack and separate items stored on shelves. Made of highly durable ABS plastic. Installs directly onto solid or vented shelves. Easily removable for relocating or washing.

CODE	DIMENSION D x H
CSSD188	460 x 203 mm
CSSD218	540 x 203
CSSD248	610 x 203
Case Pack: 1 Color: Soft Grey (151).	



Shelf Divider Bars (for 610 mm deep shelf only)

Create a custom service or storage station for food pans, boxes or dish racks. Install straight or angled dividers directly onto shelf traverses.

CODE	DESCRIPTION
CSDBA	Angled Divider Bar
CSDBS	Straight Divider Bar
Case Pack: 4 Color: Speckled Grey (480).	



CAMSHELVING® PREMIUM SERIES ACCESSORIES

Shelf Rails

Install onto traverses and dovetails to prevent items from falling off sides and ends of shelves. Choose from single or double rail side kits and double rail only end kits.

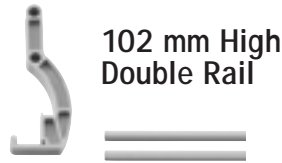

DOUBLE RAIL CODE	LENGTH
CPFL242	610 mm
CPFL302	765
CPFL362	915
CPFL422	1070
CPFL482	1220
CPFL542	1375
CPFL602	1525
CPFL722	1830



SINGLE RAIL CODE	LENGTH
CPFL241	610 mm
CPFL301	765
CPFL361	915
CPFL421	1070
CPFL481	1220
CPFL541	1375
CPFL601	1525
CPFL721	1830

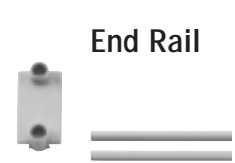

END RAIL CODE	LENGTH
CPFE14	360 mm
CPFE18	460
CPFE21	540
CPFE24	610

Color: Speckled Grey (480).

Tray Sliding Rack (for 610 mm deep shelf only)

Holds up to 6 each full size (1826) 46 x 66 cm or 12 half size (1318) 32 x 45 cm sheet pans or trays. Install 1 or more units onto vented shelves, any length. High quality, lightweight aluminum material is safe for use in coolers and freezers. Made from aluminum 6463 (6000 series).

CODE	DIMENSION D x L x H
CSTSR	584 x 517 x 508 mm

Case Pack: 1 Color: Silver (000).

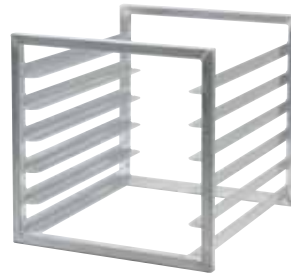

Full-Wrap Security Cage (for 610 mm deep shelf only)

Store valuable products behind locked doors. Made of heavy-duty 304 stainless steel for use in any environment. Stationary or mobile units ship complete with factory assembled post kits, 2 vented shelves, 4 premium swivel casters with total locking brake for mobile unit and 1 full wrap security cage. Assembly required. Lock not included.

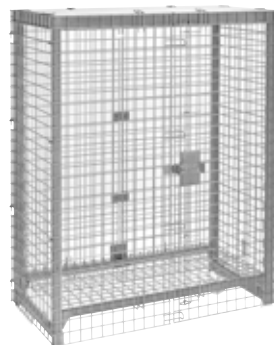

Security cage only, shelving frame not included.



Ships standard with 2 Vented Shelf Kits



CODE	CPFWSC244860	CPU244864SUPKG	CPMU244867SUPKG
DESCRIPTION	Full-wrap security cage only	Full-wrap stationary security unit	Full-wrap mobile security unit
DIMENSION D x L x H	680 x 1276 x 1562 mm	680 x 1276 x 1638 mm	680 x 1276 x 1721 mm
COLOR	Silver (000)	Speckled Grey (480)	Speckled Grey (480)
Case Pack: 1			

Cage only ships in  1 Units ship in  2

CAMSHELVING® PREMIUM SERIES ACCESSORIES

Single Shelf Security Cage (for 610 mm deep shelf only)

Securely store valuable products on a single shelf. Made of heavy duty, 304 stainless steel for use in any environment. Requires 457 mm height between shelves. Install on vented shelves only. Lock not included.

CODE	DIMENSION D x L x H
CSSC244818	640 x 1080 x 460 mm
Case Pack: 1	Color: Silver (000).



Shelf Traverses

Available in single or double packs. Use a single set to add an open shelf for divider bars or drying racks. Add single traverses onto back posts for extra support when placing rolling equipment under the first shelf.

LENGTH	SINGLE PACK CODE*	DOUBLE PACK CODE**
610 mm	CPTR24	—
765	CPTR30	—
915	CPTR36	CPTR362PK
1070	CPTR42	CPTR422PK
1220	CPTR48	CPTR482PK
1375	CPTR54	CPTR542PK
1525	CPTR60	CPTR602PK
1830	CPTR72	—

* Case Pack: 1 ** Case Pack: 2
Color: Speckled Grey (480).



Vertical Drying and Storage Cradle (for 610 mm deep shelf only)

Modular 7-slot rack designed for drying and storing trays, sheet pans, cutting boards and lids. Installs directly onto shelf traverses. Made of highly durable ABS plastic. Available in single or 3 pack.

CODE	DIMENSIONS D x L x H	CASE PACK
CSDR7	597 x 260 x 95 mm	1
CSDR73	597 x 260 x 95	3

Color: Soft Grey (151).



Vertical Drying and Storage Rack

Promotes sanitary drying, safe handling and efficient product organization with easy access to product.

Units ship complete with factory assembled mobile post kits, 6 traverses, 12 or 15 vertical drying cradles and premium swivel casters with total locking brake. Assembly required.

CODE	DIMENSIONS D x L x H	HOLDING CAPACITY
CPMU244875DRPKG	610 x 1220 x 1980 mm	84 trays
CPMU246075DRPKG	610 x 1530 x 1980	105 trays

Color: Speckled Grey (480).



1220 mm long
unit ships in



1530 mm long
unit ships in



CAMSHELVING® PREMIUM SERIES ACCESSORIES

Dome Drying and Storage Cradle (for 540 mm deep shelf only)

Use to dry and safely store up to 10 patient meal delivery domes or plate covers upright. Installs directly onto shelf traverses. Made of highly durable ABS plastic. Available in single or 5 pack.

CODE	DIMENSIONS D x L x H	CASE PACK
CSDDC	520 x 415 x 86 mm	1
CSDDC5	520 x 415 x 86	5

Color: Soft Grey (151).



Dome Drying and Storage Rack

Promotes sanitary drying, safe handling and efficient product organization with easy access to product.

Unit ships complete with factory assembled mobile post kits, 10 traverses, 10 dome drying cradles and premium swivel casters with total locking brake. Assembly required.

CODE	DIMENSIONS D x L x H	HOLDING CAPACITY
CPMU213675DDPKG	540 x 915 x 1910 mm	100 domes

Color: Speckled Grey (480).



Ships in  3

Angled Drying and Storage Cradle (for 610 mm deep shelf only)

Uniquely designed cradle holds up to 8 each meal delivery pellets or use to dry, store and transport food pans and other commercial kitchen ware. Installs directly onto shelf traverses. Made of highly durable ABS plastic. Available in single or 4 pack.

CODE	DIMENSIONS D x L x H	CASE PACK
CSDR8	592 x 263 x 160 mm	1
CSDR84	592 x 263 x 160	4

Color: Soft Grey (151).



Angled Drying and Storage Rack

Promotes sanitary drying, safe handling and efficient product organization with easy access to product.

Unit ships complete with 2 factory assembled mobile post kits, 8 traverses, 16 angled drying cradles and premium swivel casters with total locking brake. Assembly required.

CODE	DIMENSIONS D x L x H	HOLDING CAPACITY
CPMU244875PDPKG	610 x 1220 x 1980 mm	128 Pellets and Bases or 16 GN 1/1 Food Pans

Color: Speckled Grey (480).



Ships in  5

CAMSHELVING® PREMIUM SERIES

High Density Storage Floor Track System

Maximize storage capacity by creating storage aisles in all available space. This simple system is composed of stationary starter units anchored to a raised floor track system at both ends with high density mobile units installed in between. Easy to install track requires no drilling or gluing.



High Density Mobile Units are available with factory assembled post kits, vented or solid shelves and high density casters and bumpers. Full track and extension kits ship complete with required hardware. Stationary Starter Units are required to anchor the system at both ends. Choose from a wide selection (see pages 98-99).



Stationary Unit*

High Density Mobile Units

Stationary Unit

Raised Floor Track provides a smooth and level surface to easily roll mobile units. Raised track ensures dirt will not get trapped and is easy to clean. Aluminum track and stainless steel hardware are rust resistant.



Grooved casters roll easily and securely on raised track.



Raised track connects easily to the bottom of a stationary unit that works as a system anchor. No bolts, no glue or drilling into the floor are required. Easy and fast set up.

* It is recommended to use a stationary unit for every 4,6 m of track to further stabilize the system.

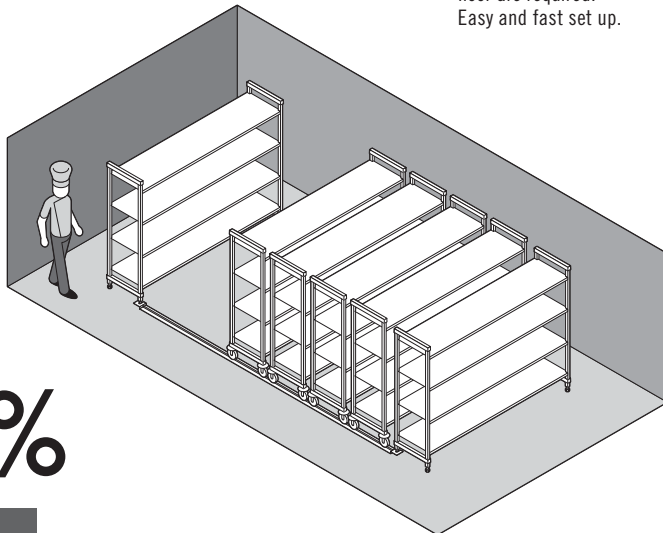
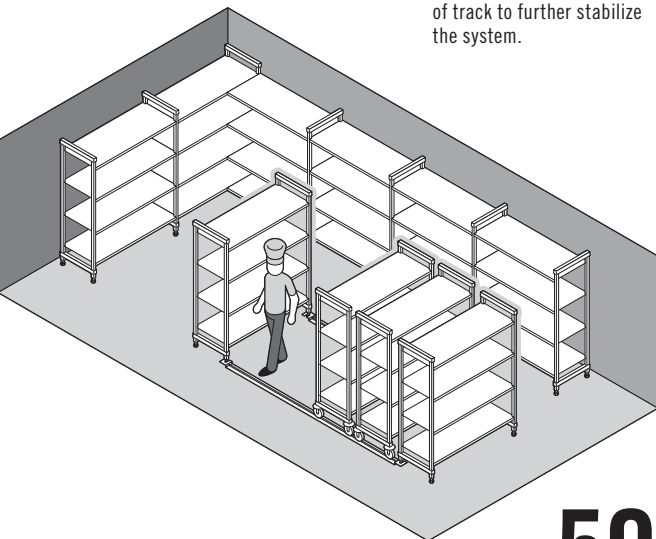

Increases Storage Capacity Up To **50%**

4-Shelf Vented High Density Mobile Starter Units

Units include 2 factory assembled mobile post kits, 4 shelves, 4 high density casters and 4 high density bumpers.

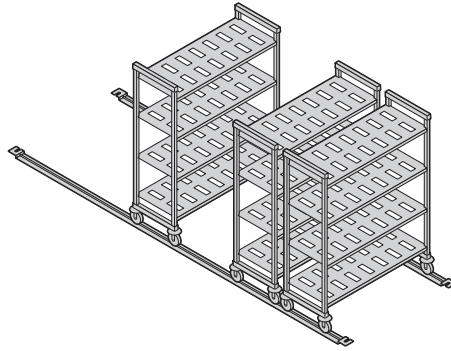

HEIGHTS*	DEPTHS	LENGTHS
2	2	5
1700 mm	540 mm	915 mm
1910	610	1070
		1220
		1375
		1525

* Includes 127 mm casters.

Ships in



4-Shelf Solid High Density Mobile Starter Units

Units include 2 factory assembled mobile post kits, 4 shelves, 4 high density casters and 4 high density bumpers.

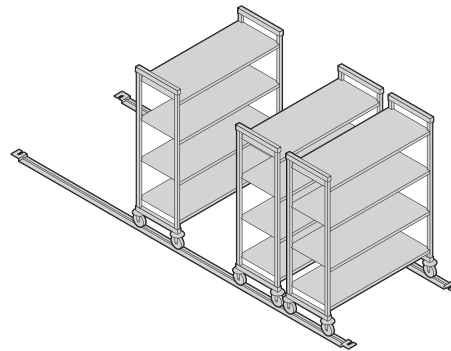

HEIGHTS*	DEPTHS	LENGTHS
2	2	5
1700 mm	540 mm	915 mm
1910	610	1070
		1220
		1375
		1525

* Includes 127 mm casters.

Ships in



Full Track and Extension Kits

Aluminum raised track kits and track extensions ship complete in 1 box. Each kit includes all stainless steel hardware necessary to complete a floor installation.

It is highly recommended to install a stationary starter unit every 4,6 m of track to further stabilize the system.



Full Track LENGTHS	Track Extension LENGTHS
3	3
3,05 m	1,38 m
3,66	1,53
4,42	1,83

Ships in



High Density Caster with Donut Bumper

Grooved caster rolls easily and securely on raised track. Donut bumper protects mobile units from coming into direct contact with each other.



V4

4-SHELF VENTED HIGH DENSITY MOBILE UNITS

S4

4-SHELF SOLID HIGH DENSITY MOBILE UNITS

Units include 2 factory assembled mobile post kits, 4 shelves, 4 high density casters and 4 high density bumpers. Units ship complete in 1 box.

1700
mm
HEIGHT

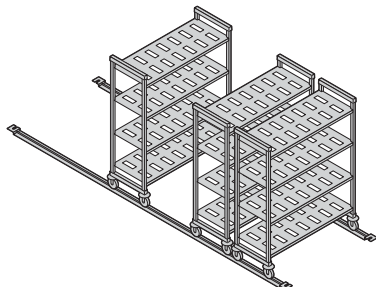

540 mm
DEPTH

CODE	DIMENSIONS D x L x H
CPHU213667V4	540 x 915 x 1700 mm
CPHU214267V4	540 x 1070 x 1700
CPHU214867V4	540 x 1220 x 1700
CPHU215467V4	540 x 1375 x 1700
CPHU216067V4	540 x 1525 x 1700

610 mm
DEPTH

CPHU243667V4	610 x 915 x 1700 mm
CPHU244267V4	610 x 1070 x 1700
CPHU244867V4	610 x 1220 x 1700
CPHU245467V4	610 x 1375 x 1700
CPHU246067V4	610 x 1525 x 1700

1910
mm
HEIGHT

540 mm
DEPTH

CODE	DIMENSIONS D x L x H
CPHU213675V4	540 x 915 x 1910 mm
CPHU214275V4	540 x 1070 x 1910
CPHU214875V4	540 x 1220 x 1910
CPHU215475V4	540 x 1375 x 1910
CPHU216075V4	540 x 1525 x 1910

610 mm
DEPTH

CPHU243675V4	610 x 915 x 1910 mm
CPHU244275V4	610 x 1070 x 1910
CPHU244875V4	610 x 1220 x 1910
CPHU245475V4	610 x 1375 x 1910
CPHU246075V4	610 x 1525 x 1910

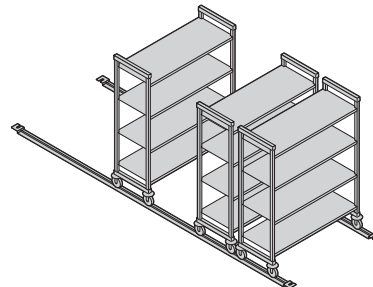

CODE	DIMENSIONS D x L x H
CPHU213667S4	540 x 915 x 1700 mm
CPHU214267S4	540 x 1070 x 1700
CPHU214867S4	540 x 1220 x 1700
CPHU215467S4	540 x 1375 x 1700
CPHU216067S4	540 x 1525 x 1700

CPHU243667S4	610 x 915 x 1700 mm
CPHU244267S4	610 x 1070 x 1700
CPHU244867S4	610 x 1220 x 1700
CPHU245467S4	610 x 1375 x 1700
CPHU246067S4	610 x 1525 x 1700

CODE	DIMENSIONS D x L x H
CPHU213675S4	540 x 915 x 1910 mm
CPHU214275S4	540 x 1070 x 1910
CPHU214875S4	540 x 1220 x 1910
CPHU215475S4	540 x 1375 x 1910
CPHU216075S4	540 x 1525 x 1910

CPHU243675S4	610 x 915 x 1910 mm
CPHU244275S4	610 x 1070 x 1910
CPHU244875S4	610 x 1220 x 1910
CPHU245475S4	610 x 1375 x 1910
CPHU246075S4	610 x 1525 x 1910

Full Track and Extension Kits

Aluminum raised track kits and track extensions ship complete in 1 box. Each kit includes all stainless steel hardware necessary to complete a floor installation.

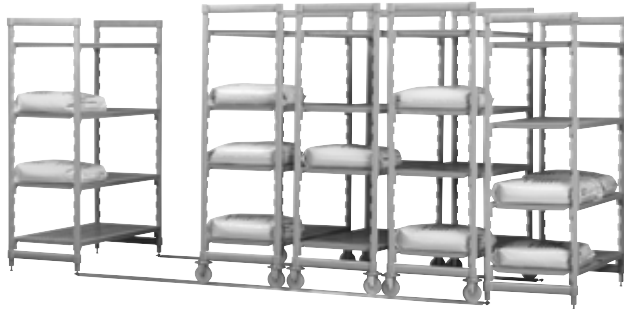

It is highly recommended to install a stationary starter unit every 4,6 m of track to further stabilize the system.

CODE	DESCRIPTION	CASE PACK
Floor Track Kit		
CSMHDTK10	3,05 m Track for 3 Mobile Units*	1
CSMHDTK12	3,66 m Track for 4 Mobile Units*	1
CSMHDTK145	4,42 m Track for 5 Mobile Units*	1
Floor Track Extension		
CSMHDTKE4 New!	1,38 m Track Extension	1
CSMHDTKE5 New!	1,53 m Track Extension	1
CSMHDTKE6 New!	1,83 m Track Extension	1
Accessories		
CSHDF	Floor Fastener	4

Color: Silver (000). * Based on 610 mm deep mobile units.

High Density Caster with Donut Bumper



CODE	SIZE
CPMCHD	127 mm

Case Pack: 2
Color: Grey (000).



CAMSHELVING® ELEMENTS series

WHY CHOOSE ELEMENTS?

Made from a revolutionary, extremely strong composite material with a smooth, easy to clean surface. Elements Series is stronger than common wire shelving. It's lighter in weight than Camshelving Premium Series and totally impervious to moisture, chemicals and liquids that can destroy shelving over time. Elements Series is designed for medium to heavy storage use in freezers, coolers, dry storage or warewashing areas. It easily supports the performance demands of a busy foodservice operation.



All Environments
-38°C TO 88°C

Stationary

Mobile

camguard
ANTIMICROBIAL SHELF PLATES



Post Connectors, Corner Connectors, Seismic Foot, Wall Fastener, Identification Tags, Single Shelf Security Cage, Tray Slide Rack, and Shelf Divider Bars are not NSF Listed.

storage needs
MEDIUM to HEAVY

weekly deliveries
5 – 7

CAMSHELVING® ELEMENTS SERIES
STATIONARY UNIT SIZES

MOBILE UNIT SIZES

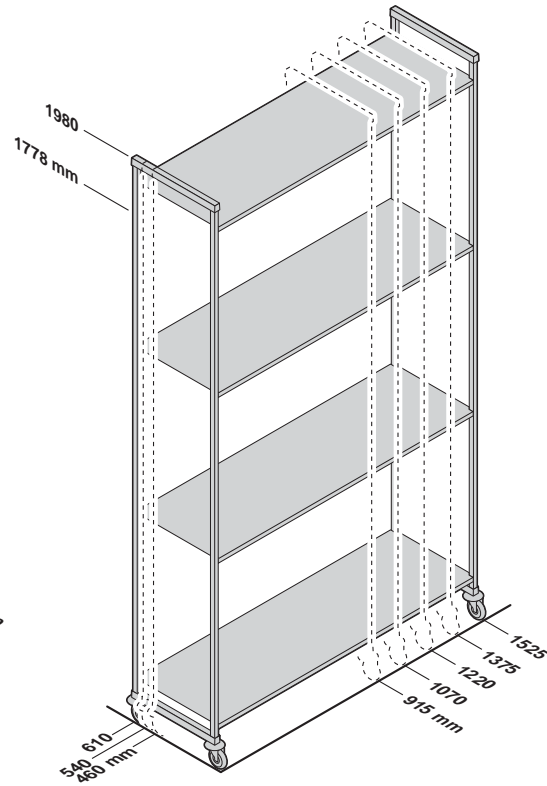
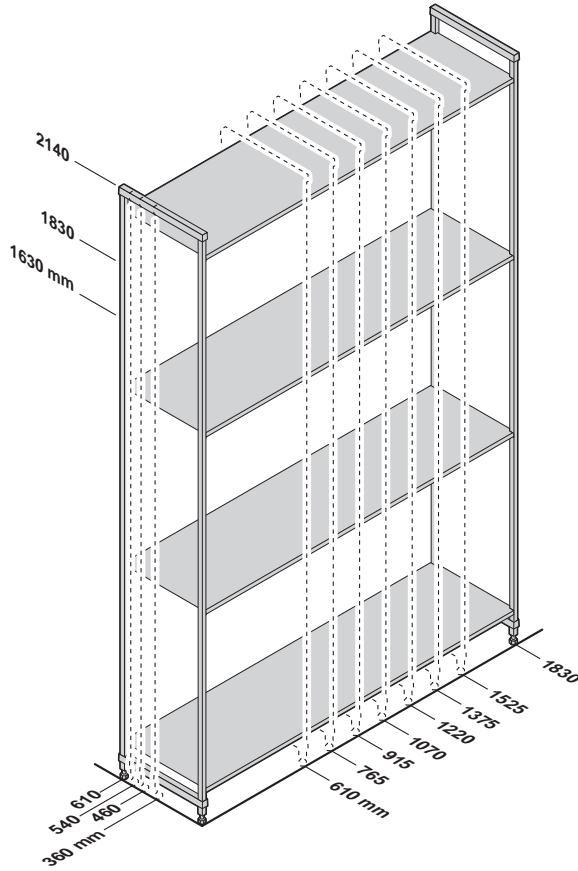

4 SHELF UNIT WEIGHT BEARING CHART

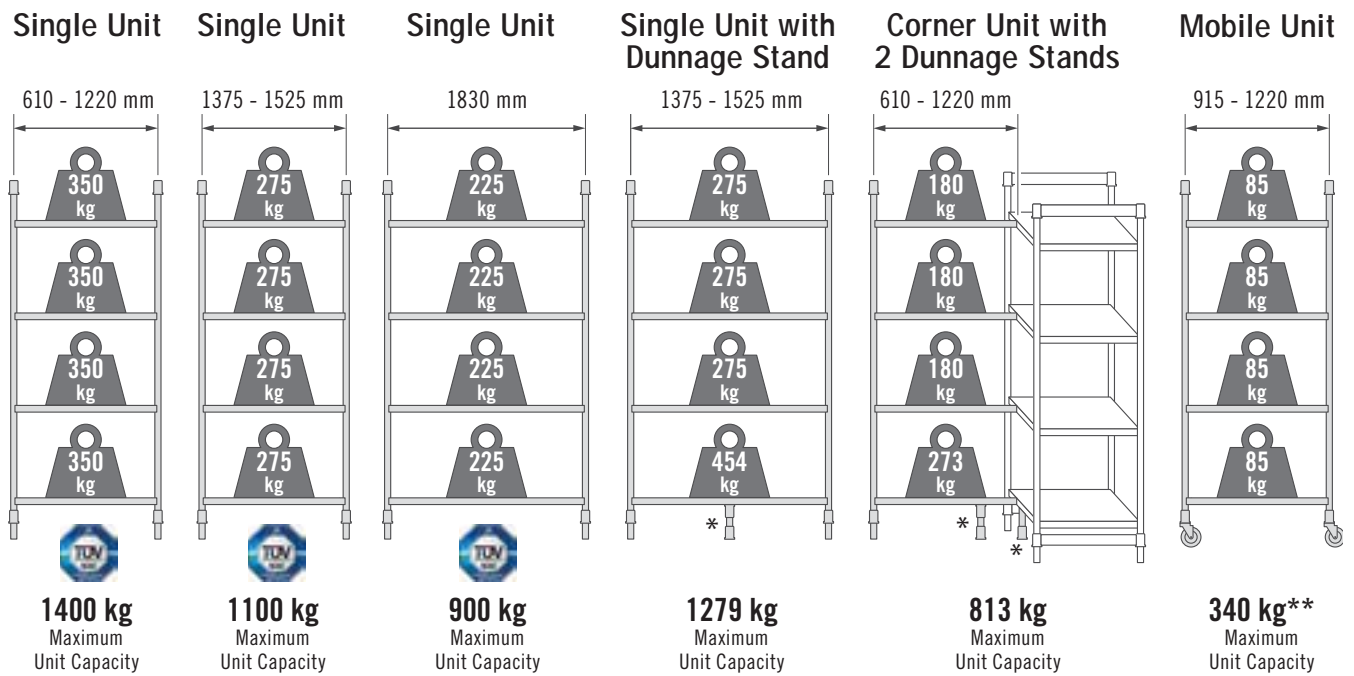

* Dunnage Stands add stability and increase weight bearing capacity on bottom shelf only. Add to any shelf length. Highly recommended for Starter Units 1375 mm and longer, all Corner Units, U-Shape Units and units specified for heavier loads (see page 92).

** Due to the weight bearing capacity of casters, maximum weight load on an entire Mobile Unit is 340 kg.

CAMSHELVING® ELEMENTS SERIES

Starter, Add-On and Mobile Units

These units make ordering easy and saves time and labor during installation. Units ship complete in one box. Post kits are pre-assembled at the factory, speeding up on site set up.



4-Shelf Vented Stationary Starter and Add-On Units

Starter units include 2 factory assembled post kits and shelves.
Add-On units include 1 factory assembled post kit and shelves.

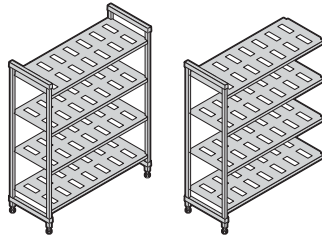

HEIGHTS	DEPTHS	LENGTHS	
3	3	8	
1630 mm	460 mm	610 mm	1220 mm
1830	540	765	1375
2140	610	915	1525
		1070	1830

Ships in  1

4-Shelf Solid Stationary Starter and Add-On Units

Starter units include 2 factory assembled post kits and shelves.
Add-On units include 1 factory assembled post kit and shelves.

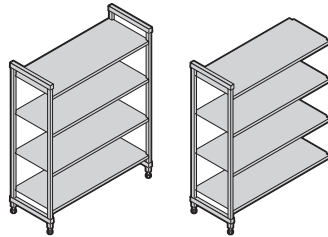

HEIGHTS	DEPTHS	LENGTHS	
3	3	8	
1630 mm	460 mm	610 mm	1220 mm
1830	540	765	1375
2140	610	915	1525
		1070	1830

Ships in  1

4-Shelf Vented and Solid Stationary Starter and Add-On Units (3 vented + 1 solid)

Starter units include 2 factory assembled post kits and shelves.
Add-On units include 1 factory assembled post kit and shelves.

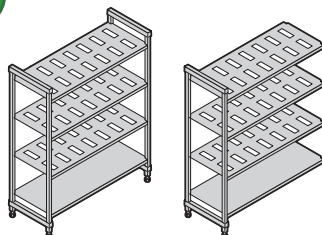

Install solid shelf on bottom to prevent water/cleaning solutions from sloshing up onto stored products. Install solid shelf on top to protect product stored on lower shelves from condensation in cooler.

HEIGHTS	DEPTHS	LENGTHS	
3	3	8	
1630 mm	460 mm	610 mm	1220 mm
1830	540	765	1375
2140	610	915	1525
		1070	1830

Ships in  1

5-Shelf Vented Stationary Starter and Add-On Units

Starter units include 2 factory assembled post kits and shelves.

Add-On units include 1 factory assembled post kit and shelves.

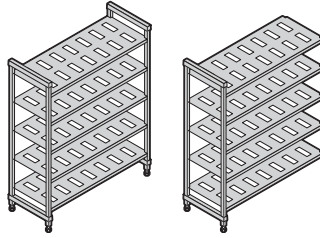

HEIGHTS	DEPTHS	LENGTHS	
3	3	8	
1630 mm	460 mm	610 mm	1220 mm
1830	540	765	1375
2140	610	915	1525
		1070	1830

Ships in  4

5-Shelf Solid Stationary Starter and Add-On Units

Starter units include 2 factory assembled post kits and shelves.

Add-On units include 1 factory assembled post kit and shelves.

New!

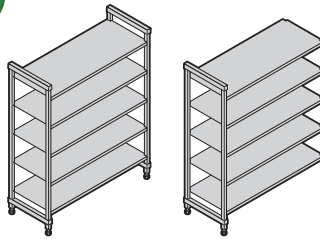

HEIGHT	DEPTHS	LENGTHS	
1	3	8	
2140 mm	460 mm	610 mm	1220 mm
	540	765	1375
	610	915	1525
		1070	1830

Ships in  4

5-Shelf Vented and Solid Stationary Starter And Add-On Units (4 vented + 1 solid)

Starter units include 2 factory assembled post kits and shelves.

Add-On units include 1 factory assembled post kit and shelves.

Install solid shelf on bottom to prevent water/cleaning solutions from sloshing up onto stored products.

Install solid shelf on top to protect product stored on lower shelves from condensation in cooler.

New!

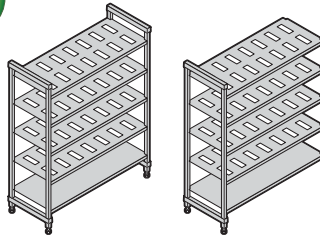

HEIGHT	DEPTHS	LENGTHS	
1	3	8	
2140 mm	460 mm	610 mm	1220 mm
	540	765	1375
	610	915	1525
		1070	1830

Ships in  4

4 or 5-Shelf Vented Mobile Starter Units

Mobile starter units include 2 factory assembled mobile post kits, shelves and 4 premium swivel casters with total locking brake.

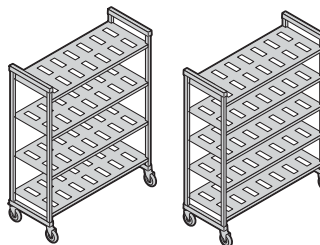

HEIGHTS*	DEPTHS	LENGTHS	
2	3	5	
1778 mm	460 mm	915 mm	1375 mm
1980	540	1070	1525
	610	1220	

* Includes 127 mm casters.

Ships in  4



Visit the Camshelving Microsite at www.cambro.com/camshelving for product information and pricing on all available shelving products. View or download the Camshelving Specification and Price List. Or scan QR code.

ELEMENTS
SERIES

V4

4-SHELF VENTED UNITS

1630
mm
HEIGHT

Starter units include 2 factory assembled stationary post kits, stationary traverses, stationary traverse dovetails and shelf plates. Add-On units include 1 factory assembled stationary post kit, stationary traverses, stationary traverse dovetails and shelf plates. Units ship complete in 1 box.

Starter

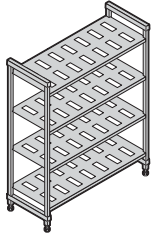

Add-On

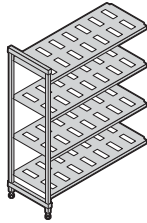

460 mm
DEPTH

DIMENSIONS
D x L x H

460 x 610 x 1630 mm
460 x 765 x 1630
460 x 915 x 1630
460 x 1070 x 1630
460 x 1220 x 1630
460 x 1375 x 1630
460 x 1525 x 1630
460 x 1830 x 1630

CODE

ESU182464V4
ESU183064V4
ESU183664V4
ESU184264V4
ESU184864V4
ESU185464V4
ESU186064V4
ESU187264V4

CODE

EA182464V4
EA183064V4
EA183664V4
EA184264V4
EA184864V4
EA185464V4
EA186064V4
EA187264V4

540 mm
DEPTH

540 x 610 x 1630 mm
540 x 765 x 1630
540 x 915 x 1630
540 x 1070 x 1630
540 x 1220 x 1630
540 x 1375 x 1630
540 x 1525 x 1630
540 x 1830 x 1630

ESU212464V4
ESU213064V4
ESU213664V4
ESU214264V4
ESU214864V4
ESU215464V4
ESU216064V4
ESU217264V4

EA212464V4
EA213064V4
EA213664V4
EA214264V4
EA214864V4
EA215464V4
EA216064V4
EA217264V4

610 mm
DEPTH

610 x 610 x 1630 mm
610 x 765 x 1630
610 x 915 x 1630
610 x 1070 x 1630
610 x 1220 x 1630
610 x 1375 x 1630
610 x 1525 x 1630
610 x 1830 x 1630

ESU242464V4
ESU243064V4
ESU243664V4
ESU244264V4
ESU244864V4
ESU245464V4
ESU246064V4
ESU247264V4

EA242464V4
EA243064V4
EA243664V4
EA244264V4
EA244864V4
EA245464V4
EA246064V4
EA247264V4

ELEMENTS
SERIES

V4

4-SHELF VENTED UNITS

1830
mm
HEIGHT

Starter units include 2 factory assembled stationary post kits, stationary traverses, stationary traverse dovetails and shelf plates. Add-On units include 1 factory assembled stationary post kit, stationary traverses, stationary traverse dovetails and shelf plates. Units ship complete in 1 box.

Starter

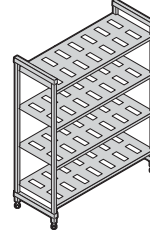

Add-On

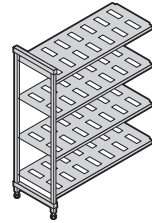

DIMENSIONS
D x L x H

460 x 610 x 1830 mm
460 x 765 x 1830
460 x 915 x 1830
460 x 1070 x 1830
460 x 1220 x 1830
460 x 1375 x 1830
460 x 1525 x 1830
460 x 1830 x 1830

CODE

ESU182472V4
ESU183072V4
ESU183672V4
ESU184272V4
ESU184872V4
ESU185472V4
ESU186072V4
ESU187272V4

CODE

EA182472V4
EA183072V4
EA183672V4
EA184272V4
EA184872V4
EA185472V4
EA186072V4
EA187272V4

540 x 610 x 1830 mm
540 x 765 x 1830
540 x 915 x 1830
540 x 1070 x 1830
540 x 1220 x 1830
540 x 1375 x 1830
540 x 1525 x 1830
540 x 1830 x 1830

ESU212472V4
ESU213072V4
ESU213672V4
ESU214272V4
ESU214872V4
ESU215472V4
ESU216072V4
ESU217272V4

EA212472V4
EA213072V4
EA213672V4
EA214272V4
EA214872V4
EA215472V4
EA216072V4
EA217272V4

610 x 610 x 1830 mm
610 x 765 x 1830
610 x 915 x 1830
610 x 1070 x 1830
610 x 1220 x 1830
610 x 1375 x 1830
610 x 1525 x 1830
610 x 1830 x 1830

ESU242472V4
ESU243072V4
ESU243672V4
ESU244272V4
ESU244872V4
ESU245472V4
ESU246072V4
ESU247272V4

EA242472V4
EA243072V4
EA243672V4
EA244272V4
EA244872V4
EA245472V4
EA246072V4
EA247272V4

Color: Brushed Graphite (580).

ELEMENTS
SERIES

V5

5-SHELF VENTED UNITS

2140
mm
HEIGHT

Starter units include 2 factory assembled stationary post kits, stationary traverses, stationary traverse dovetails and shelf plates. Add-On units include 1 factory assembled stationary post kit, stationary traverses, stationary traverse dovetails and shelf plates. Units ship complete in 1 box.

Starter

Add-On

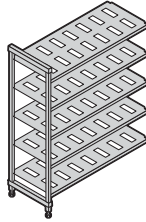
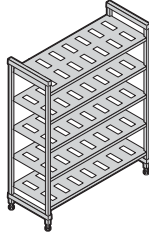

460 mm
DEPTH

DIMENSIONS D x L x H

460 x 610 x 2140 mm
460 x 765 x 2140
460 x 915 x 2140
460 x 1070 x 2140
460 x 1220 x 2140
460 x 1375 x 2140
460 x 1525 x 2140
460 x 1830 x 2140

CODE

ESU182484V5
ESU183084V5
ESU183684V5
ESU184284V5
ESU184884V5
ESU185484V5
ESU186084V5
ESU187284V5

CODE

EA182484V5
EA183084V5
EA183684V5
EA184284V5
EA184884V5
EA185484V5
EA186084V5
EA187284V5

540 mm
DEPTH

540 x 610 x 2140 mm
540 x 765 x 2140
540 x 915 x 2140
540 x 1070 x 2140
540 x 1220 x 2140
540 x 1375 x 2140
540 x 1525 x 2140
540 x 1830 x 2140

ESU212484V5
ESU213084V5
ESU213684V5
ESU214284V5
ESU214884V5
ESU215484V5
ESU216084V5
ESU217284V5

EA212484V5
EA213084V5
EA213684V5
EA214284V5
EA214884V5
EA215484V5
EA216084V5
EA217284V5

610 mm
DEPTH

610 x 610 x 2140 mm
610 x 765 x 2140
610 x 915 x 2140
610 x 1070 x 2140
610 x 1220 x 2140
610 x 1375 x 2140
610 x 1525 x 2140
610 x 1830 x 2140

ESU242484V5
ESU243084V5
ESU243684V5
ESU244284V5
ESU244884V5
ESU245484V5
ESU246084V5
ESU247284V5

EA242484V5
EA243084V5
EA243684V5
EA244284V5
EA244884V5
EA245484V5
EA246084V5
EA247284V5

Color: Brushed Graphite (580).

ELEMENTS
SERIES

V4

4-SHELF VENTED MOBILE UNITS

Mobile units include 2 factory assembled mobile post kits, mobile traverses, mobile traverse dovetails, shelf plates, and 4 premium swivel casters with total locking brake. Units ship complete in 1 box.

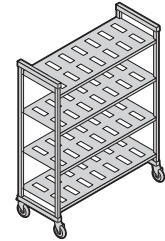

* Includes
127 mm
casters.

1778
mm
HEIGHT

460 mm
DEPTH

540 mm
DEPTH

610 mm
DEPTH

1980
mm
HEIGHT

460 mm
DEPTH

540 mm
DEPTH

610 mm
DEPTH

CODE	DIMENSIONS D x L x H*
EMU183670V4	460 x 915 x 1778 mm
EMU184270V4	460 x 1070 x 1778
EMU184870V4	460 x 1220 x 1778
EMU185470V4	460 x 1375 x 1778
EMU186070V4	460 x 1525 x 1778

EMU213670V4	540 x 915 x 1778 mm
EMU214270V4	540 x 1070 x 1778
EMU214870V4	540 x 1220 x 1778
EMU215470V4	540 x 1375 x 1778
EMU216070V4	540 x 1525 x 1778

EMU243670V4	610 x 915 x 1778 mm
EMU244270V4	610 x 1070 x 1778
EMU244870V4	610 x 1220 x 1778
EMU245470V4	610 x 1375 x 1778
EMU246070V4	610 x 1525 x 1778

CODE	DIMENSIONS D x L x H*
EMU183678V4	460 x 915 x 1980 mm
EMU184278V4	460 x 1070 x 1980
EMU184878V4	460 x 1220 x 1980
EMU185478V4	460 x 1375 x 1980
EMU186078V4	460 x 1525 x 1980

EMU213678V4	540 x 915 x 1980 mm
EMU214278V4	540 x 1070 x 1980
EMU214878V4	540 x 1220 x 1980
EMU215478V4	540 x 1375 x 1980
EMU216078V4	540 x 1525 x 1980

EMU243678V4	610 x 915 x 1980 mm
EMU244278V4	610 x 1070 x 1980
EMU244878V4	610 x 1220 x 1980
EMU245478V4	610 x 1375 x 1980
EMU246078V4	610 x 1525 x 1980



CAMSHELVING® ELEMENTS SERIES ACCESSORIES

Bottom Shelf Dunnage Stands

Increase weight bearing capacity on bottom shelf only. Add to any shelf length. Highly recommended for starter units 1375 mm and longer and all corner units, intermediate units and units specified for heavier load volume on and off bottom shelves.

CODE	DIMENSIONS D x H*
Dunnage Stand – Low	
EDS14H6	360 x 165 mm
EDS18H6	460 x 165
EDS21H6	540 x 165
EDS24H6	610 x 165
Dunnage Stand – Tall	
New! EDS14H10	360 x 267
New! EDS18H10	460 x 267
New! EDS21H10	540 x 267
New! EDS24H10	610 x 267

Case Pack: 1
Color: Brushed Graphite (580).

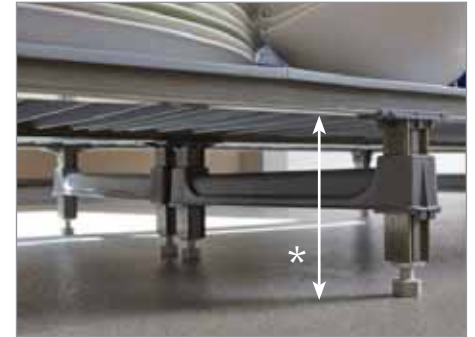

Corner Connectors

Unique patented design ensures maximum shelf space utilization. Use 1 set per shelf to connect starter and add-on units in corners. Connect 4 or 5 intermediate shelves between 2 starter units (2 sets required per shelf). Available as a single set or 8 or 10 set packs.

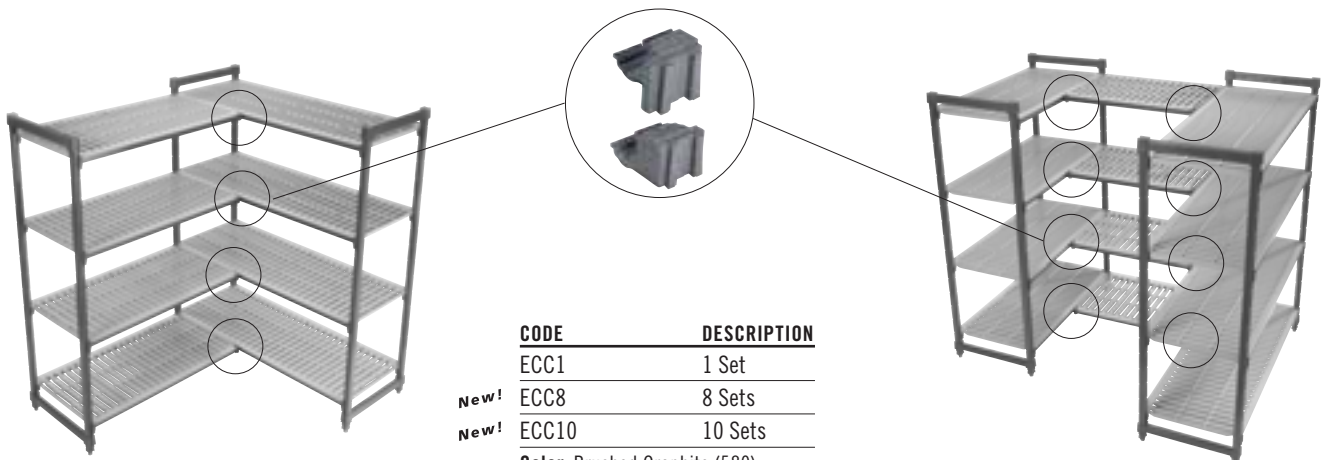

CODE	DESCRIPTION
ECC1	1 Set
New! ECC8	8 Sets
New! ECC10	10 Sets

Color: Brushed Graphite (580).

CAMSHELVING® ELEMENTS SERIES ACCESSORIES

Identification Tags

Clip onto shelf traverses to clearly identify stored product. Made of highly durable plastic with a clear slide in front panel. Labels included.

CODE	DESCRIPTION	DIMENSION L x H
CSID6	152 mm ID Tag	152 x 25 mm
CSID3	76 mm ID Tag	76 x 25

Case Pack: 12 **Color:** White / Clear.



Wall Fastener

Use to secure stationary shelving unit to a wall for added safety and stability where required. Made of stainless steel. Screws not included.

CODE	DIMENSION D x L x H
CSWF	73 x 238 x 48 mm

Case Pack: 4 **Color:** Silver (000).



Hole diameter 1,11 cm



Seismic Foot

Secure stationary unit posts directly to the floor for added safety and stability where required. Made of stainless steel. Bolts not included.

CODE	DIMENSION D x L x H
CSEQ3	102 x 83 x 59 mm

Case Pack: 4 **Color:** Silver (000).



Hole diameter 1,43 cm



Premium Caster

Ideal in all areas of storage, especially coolers, freezers and/or wet areas. Made of highly durable, non-corrosive plastic with a 127 mm swivel, non-marking thermoplastic rubber wheel. Total locking brake locks both swivel motion and the wheel.

CODE	SIZE
EMCWB	127 mm

Case Pack: 2 **Color:** Grey (000).



CAMSHELVING® ELEMENTS SERIES ACCESSORIES

Donut Bumper

Offers added protection during transport and when maneuvering mobile units into place against walls or alongside other units for storage.

CODE	DIAMETER
CSMHDDB	127 mm
Case Pack: 4 Color: Grey (000).	

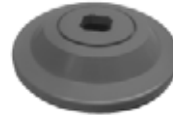

Shelf Divider

Stack and separate items stored on shelves. Made of highly durable ABS plastic. Installs directly onto solid or vented shelves. Easily removable for relocating or washing.

CODE	DIMENSION D x H
CSSD188	460 x 203 mm
CSSD218	540 x 203
CSSD248	610 x 203
Case Pack: 1 Color: Soft Grey (151).	



Shelf Divider Bars (for 610 mm deep shelf only)

Create a custom service or storage station for food pans, boxes or dish racks. Install straight or angled dividers directly onto shelf traverses.

CODE	DESCRIPTION
EDBA	Angled Divider Bar
EDBS	Straight Divider Bar
Case Pack: 4 Color: Speckled Grey (480).	



Tray Sliding Rack (for 610 mm deep shelf only)

Holds up to 6 each full size (1826) 46 x 66 cm or 12 half size (1318) 32 x 45 cm sheet pans or trays. Install 1 or more units onto vented shelves, any length. High quality, lightweight aluminum material is safe for use in coolers and freezers. Made from aluminum 6463 (6000 series).

CODE	DIMENSION D x L x H
CSTR	584 x 517 x 508 mm
Case Pack: 1 Color: Silver (000).	



CAMSHELVING® ELEMENTS SERIES ACCESSORIES

Single Shelf Security Cage (for 610 mm deep shelf only)

Securely store valuable products on a single shelf. Made of heavy duty, 304 stainless steel for use in any environment. Requires 457 mm height between shelves. Install on vented shelves only. Lock not included.

CODE	DIMENSION D x L x H
CSSC244818	640 x 1080 x 460 mm
Case Pack: 1 Color: Silver (000).	



Shelf Traverses

Available in single or double packs, stationary or mobile. Use two traverses to add an open shelf for divider bars or drying cradles. Add one stationary traverse onto back posts of a stationary unit for extra support when placing rolling equipment under the first shelf. Traverse dovetails included.

Stationary Traverse

LENGTH	SINGLE PACK CODE*	DOUBLE PACK CODE**
610 mm	ETR24	—
765	ETR30	—
915	ETR36	ETR362PK
1070	ETR42	ETR422PK
1220	ETR48	ETR482PK
1375	ETR54	ETR542PK
1525	ETR60	ETR602PK
1830	ETR72	—

* Case Pack: 1 ** Case Pack: 2
Color: Brushed Graphite (580).



Stationary
Traverse

Mobile Traverse

LENGTH	SINGLE PACK CODE*	DOUBLE PACK CODE**
915 mm	EMTR36	EMTR362PK
1070	EMTR42	EMTR422PK
1220	EMTR48	EMTR482PK
1375	EMTR54	EMTR542PK
1525	EMTR60	EMTR602PK

* Case Pack: 1 ** Case Pack: 2
Color: Brushed Graphite (580).



Mobile
Traverse

Dome Drying and Storage Cradle (for 540 mm deep shelf only)

Use to dry and safely store up to 10 patient meal delivery domes or plate covers upright. Installs directly onto shelf traverses. Made of highly durable ABS plastic. Available in single or 5 pack.

CODE	DIMENSIONS D x L x H	CASE PACK
CSDDC	520 x 415 x 86 mm	1
CSDDC5	520 x 415 x 86	5
Color: Soft Grey (151).		



CAMSHELVING® ELEMENTS SERIES ACCESSORIES

Vertical Drying and Storage Cradle (for 610 mm deep shelf only)

Modular 7-slot rack designed for drying and storing trays, sheet pans, cutting boards and lids. Installs directly onto shelf traverses. Made of highly durable ABS plastic. Available in single or 3 pack.

CODE	DIMENSIONS D x L x H	CASE PACK
CSDR7	597 x 260 x 95 mm	1
CSDR73	597 x 260 x 95	3

Color: Soft Grey (151).



Vertical Drying and Storage Rack

Promotes sanitary drying, safe handling and efficient product organization with easy access to product.

Units ship complete with factory assembled mobile post kits, 6 mobile shelf traverses, mobile shelf traverse dovetails, 12 or 15 vertical drying cradles and premium swivel casters with total locking brake. Assembly required.

CODE	DIMENSIONS D x L x H	HOLDING CAPACITY
EMU244878DRPKG	610 x 1220 x 1980 mm	84 trays
EMU246078DRPKG	610 x 1530 x 1980	105 trays

Color: Brushed Graphite (580).

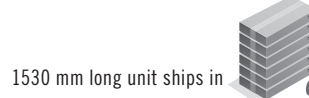
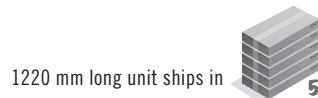

Angled Drying and Storage Cradle (for 610 mm deep shelf only)

Uniquely designed cradle holds up to 8 each meal delivery pellets or use to dry, store and transport food pans and other commercial kitchen ware. Installs directly onto shelf traverses. Made of highly durable ABS plastic. Available in single or 4 pack.

CODE	DIMENSIONS D x L x H	CASE PACK
CSDR8	592 x 263 x 160 mm	1
CSDR84	592 x 263 x 160	4

Color: Soft Grey (151).

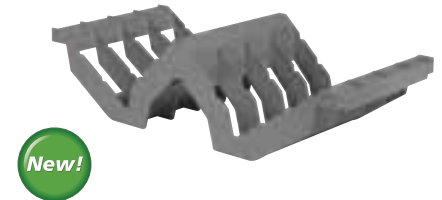

Angled Drying and Storage Rack

Promotes sanitary drying, safe handling and efficient product organization with easy access to product.

Unit ships complete with factory assembled mobile post kits, 8 mobile shelf traverses, mobile shelf traverse dovetails, 16 angled drying cradles and premium swivel casters with total locking brake. Assembly required.

CODE	DIMENSIONS D x L x H	HOLDING CAPACITY
EMU244878PDPKG	610 x 1220 x 1980 mm	128 Pellets and Bases or 16 GN 1/1 Food Pans

Color: Brushed Graphite (580).



CAMSHELVING® BASICS series

WHY CHOOSE BASICS?

Just because the budget is tight and storage needs are less rigorous, it doesn't mean that shelving performance and storage efficiencies should be compromised. Basics Series is made from the same high performing, strong composite material as Elements Series and has the same design features. It's lighter in weight and less in cost but still strong enough to handle light to medium storage demands.



All Environments
-38°C TO 88°C

Stationary



COMPONENT



Post Connectors, Corner Connectors, Seismic Foot, Wall Fastener, Identification Tags, Single Shelf Security Cage, and Tray Slide Rack are not NSF Listed.



storage needs
LIGHT to MEDIUM

weekly deliveries

2 – 5

CAMSHELVING® BASICS SERIES
STATIONARY UNIT SIZES

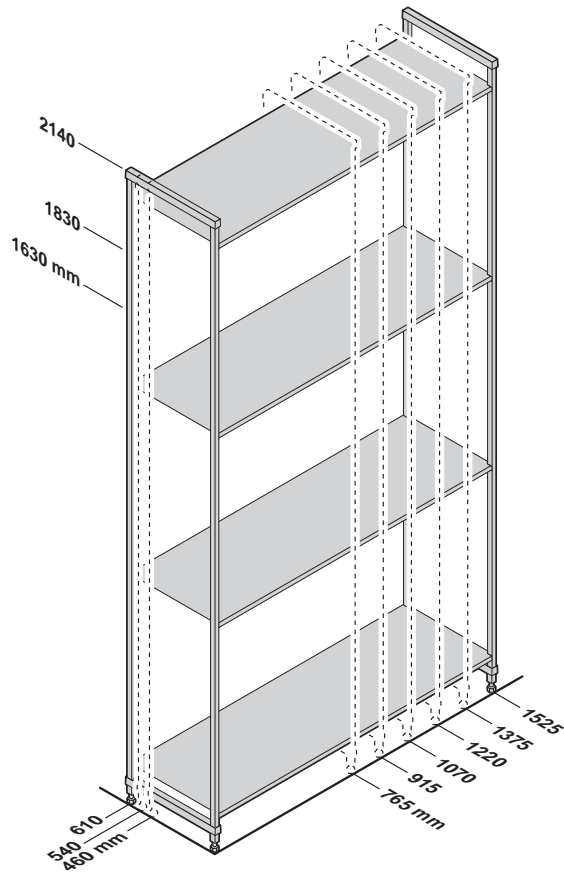

4 SHELF UNIT WEIGHT BEARING CHART

Single Unit

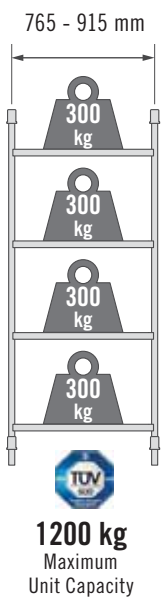

Single Unit

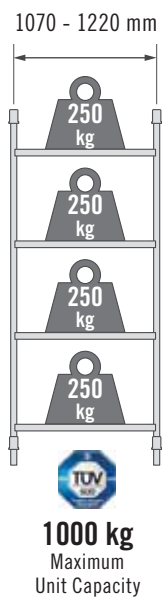

Single Unit

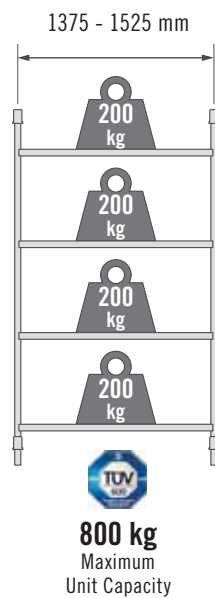

Single Unit with
Dunnage Stand

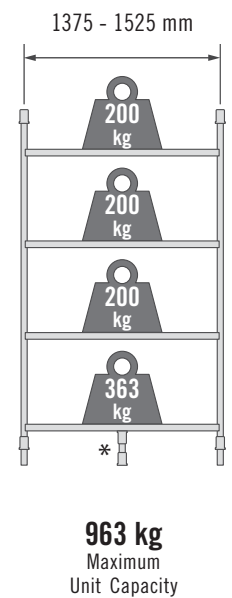

Corner Unit with
2 Dunnage Stands

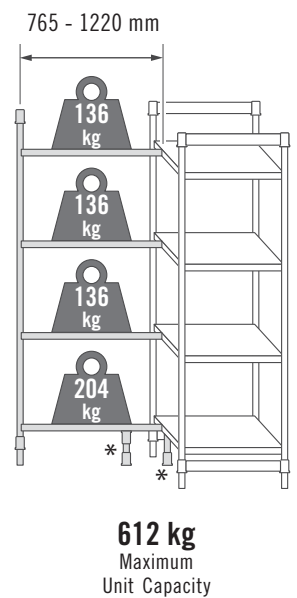

* Dunnage Stands add stability and increase weight bearing capacity on bottom shelf only. Add to any shelf length. Highly recommended for Starter Units 1375 mm and longer, all Corner Units, U-Shape Units and units specified for heavier loads (see page 92).

CAMSHELVING® BASICS SERIES

Starter, and Add-On Units

These units make ordering easy and saves time and labor during installation. Units ship complete in one box. Post kits are pre-assembled at the factory, speeding up on site set up.



4-Shelf Vented Stationary Starter and Add-On Units

Starter units include 2 factory assembled post kits and shelves.

Add-On units include 1 factory assembled post kit and shelves.

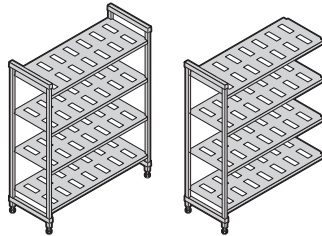

HEIGHTS	DEPTHS	LENGTHS
3	3	6
1630 mm	460 mm	765 mm 1220 mm
1830	540	915 1375
2140	610	1070 1525

Ships in  1

4-Shelf Solid Stationary Starter and Add-On Units

Starter units include 2 factory assembled post kits and shelves.

Add-On units include 1 factory assembled post kit and shelves.

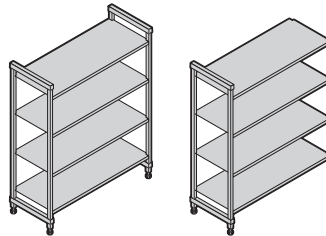

HEIGHTS	DEPTHS	LENGTHS
3	3	6
1630 mm	460 mm	765 mm 1220 mm
1830	540	915 1375
2140	610	1070 1525

Ships in  1

4-Shelf Vented and Solid Stationary Starter and Add-On Units (3 vented + 1 solid)

Starter units include 2 factory assembled post kits and shelves.

Add-On units include 1 factory assembled post kit and shelves.

Install solid shelf on bottom to prevent water/cleaning solutions from sloshing up onto stored products. Install solid shelf on top to protect product stored on lower shelves from condensation in cooler.

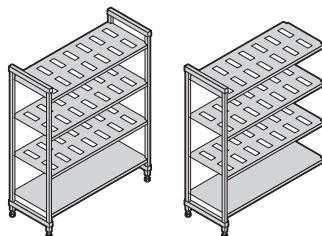

HEIGHTS	DEPTHS	LENGTHS
3	3	6
1630 mm	460 mm	765 mm 1220 mm
1830	540	915 1375
2140	610	1070 1525

Ships in  1

5-Shelf Vented Stationary Starter and Add-On Units

Starter units include 2 factory assembled post kits and shelves.

Add-On units include 1 factory assembled post kit and shelves.

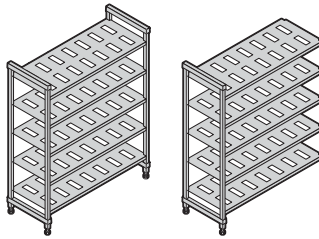

HEIGHTS	DEPTHS	LENGTHS	
3	3	6	
1630 mm	460 mm	765 mm	1220 mm
1830	540	915	1375
2140	610	1070	1525

Ships in  1

5-Shelf Solid Stationary Starter and Add-On Units

Starter units include 2 factory assembled post kits and shelves.

Add-On units include 1 factory assembled post kit and shelves.

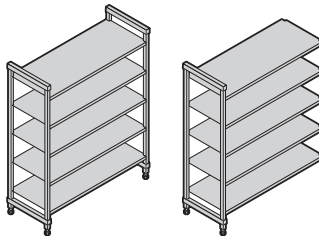

HEIGHT	DEPTHS	LENGTHS	
1	3	6	
2140 mm	460 mm	765 mm	1220 mm
	540	915	1375
	610	1070	1525

Ships in  1

5-Shelf Vented and Solid Stationary Starter And Add-On Units (4 vented + 1 solid)

Starter units include 2 factory assembled post kits and shelves.

Add-On units include 1 factory assembled post kit and shelves.

Install solid shelf on bottom to prevent water/cleaning solutions from sloshing up onto stored products. Install solid shelf on top to protect product stored on lower shelves from condensation in cooler.

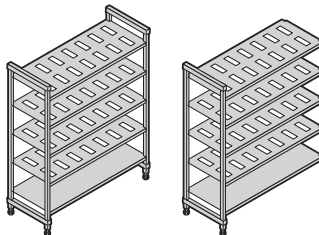

HEIGHT	DEPTHS	LENGTHS	
1	3	6	
2140 mm	460 mm	765 mm	1220 mm
	540	915	1375
	610	1070	1525

Ships in  1



Visit the Camshelving Microsite at www.cambro.com/camshelving for product information and pricing on all available shelving products. View or download the Camshelving Specification and Price List. Or scan QR code.

BASICS
SERIES

V4

4-SHELF VENTED UNITS

1630
mm
HEIGHT

Starter units include 2 factory assembled post kits and shelves. Add-on units include 1 factory assembled post kit and shelves. Units ship complete in 1 box.

Starter

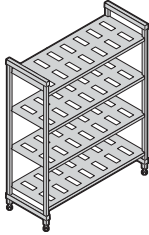

Add-On

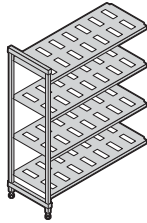

460 mm
DEPTH

DIMENSIONS
D x L x H

460 x 765 x 1630 mm
460 x 915 x 1630
460 x 1070 x 1630
460 x 1220 x 1630
460 x 1375 x 1630
460 x 1525 x 1630

CODE

CBU183064V4
CBU183664V4
CBU184264V4
CBU184864V4
CBU185464V4
CBU186064V4

CODE

CBA183064V4
CBA183664V4
CBA184264V4
CBA184864V4
CBA185464V4
CBA186064V4

540 mm
DEPTH

540 x 765 x 1630 mm
540 x 915 x 1630
540 x 1070 x 1630
540 x 1220 x 1630
540 x 1375 x 1630
540 x 1525 x 1630

CBU213064V4
CBU213664V4
CBU214264V4
CBU214864V4
CBU215464V4
CBU216064V4

CBA213064V4
CBA213664V4
CBA214264V4
CBA214864V4
CBA215464V4
CBA216064V4

610 mm
DEPTH

610 x 765 x 1630 mm
610 x 915 x 1630
610 x 1070 x 1630
610 x 1220 x 1630
610 x 1375 x 1630
610 x 1525 x 1630

CBU243064V4
CBU243664V4
CBU244264V4
CBU244864V4
CBU245464V4
CBU246064V4

CBA243064V4
CBA243664V4
CBA244264V4
CBA244864V4
CBA245464V4
CBA246064V4

BASICS
SERIES

V4

4-SHELF VENTED UNITS

1830
mm
HEIGHT

Starter units include 2 factory assembled post kits and shelves. Add-on units include 1 factory assembled post kit and shelves. Units ship complete in 1 box.

Starter

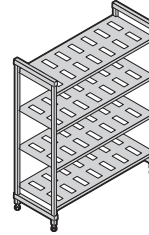

Add-On

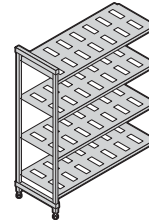

DIMENSIONS
D x L x H

460 x 765 x 1830 mm
460 x 915 x 1830
460 x 1070 x 1830
460 x 1220 x 1830
460 x 1375 x 1830
460 x 1525 x 1830

CODE

CBU183072V4
CBU183672V4
CBU184272V4
CBU184872V4
CBU185472V4
CBU186072V4

CODE

CBA183072V4
CBA183672V4
CBA184272V4
CBA184872V4
CBA185472V4
CBA186072V4

540 x 765 x 1830 mm
540 x 915 x 1830
540 x 1070 x 1830
540 x 1220 x 1830
540 x 1375 x 1830
540 x 1525 x 1830

CBU213072V4
CBU213672V4
CBU214272V4
CBU214872V4
CBU215472V4
CBU216072V4

CBA213072V4
CBA213672V4
CBA214272V4
CBA214872V4
CBA215472V4
CBA216072V4

610 x 765 x 1830 mm
610 x 915 x 1830
610 x 1070 x 1830
610 x 1220 x 1830
610 x 1375 x 1830
610 x 1525 x 1830

CBU243072V4
CBU243672V4
CBU244272V4
CBU244872V4
CBU245472V4
CBU246072V4

CBA243072V4
CBA243672V4
CBA244272V4
CBA244872V4
CBA245472V4
CBA246072V4

Color: Brushed Graphite (580).

BASICS
SERIES

V5 5-SHELF VENTED UNITS

2140
mm
HEIGHT

Starter units include 2 factory assembled post kits and shelves. Add on units include 1 factory assembled post kit and shelves. Units ship complete in 1 box.

Starter

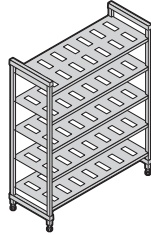

Add-On

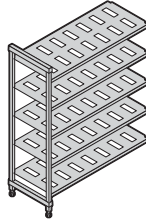

460 mm
DEPTH

DIMENSIONS
D x L x H

460 x 765 x 2140 mm
460 x 915 x 2140
460 x 1070 x 2140
460 x 1220 x 2140
460 x 1375 x 2140
460 x 1525 x 2140

CODE

CBU183084V5
CBU183684V5
CBU184284V5
CBU184884V5
CBU185484V5
CBU186084V5

CODE

CBA183084V5
CBA183684V5
CBA184284V5
CBA184884V5
CBA185484V5
CBA186084V5

540 mm
DEPTH

540 x 765 x 2140 mm
540 x 915 x 2140
540 x 1070 x 2140
540 x 1220 x 2140
540 x 1375 x 2140
540 x 1525 x 2140

CBU213084V5
CBU213684V5
CBU214284V5
CBU214884V5
CBU215484V5
CBU216084V5

CBA213084V5
CBA213684V5
CBA214284V5
CBA214884V5
CBA215484V5
CBA216084V5

610 mm
DEPTH

610 x 765 x 2140 mm
610 x 915 x 2140
610 x 1070 x 2140
610 x 1220 x 2140
610 x 1375 x 2140
610 x 1525 x 2140

CBU243084V5
CBU243684V5
CBU244284V5
CBU244884V5
CBU245484V5
CBU246084V5

CBA243084V5
CBA243684V5
CBA244284V5
CBA244884V5
CBA245484V5
CBA246084V5

Color: Brushed Graphite (580).

CAMSHELVING® BASICS SERIES ACCESSORIES

Bottom Shelf Dunnage Stands

Increase weight bearing capacity on bottom shelf only. Add to any shelf length. Highly recommended for starter units 1380 mm and longer and all corner units, intermediate units and units specified for heavier load volume on and off bottom shelves.

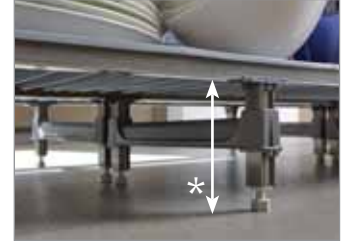

CODE	DIMENSIONS D x H*
Dunnage Stand – Low	
CBDS18H6	460 x 171 mm
CBDS21H6	540 x 171
CBDS24H6	610 x 171
Dunnage Stand – Tall	
CBDS18H10 <i>New!</i>	460 x 273
CBDS21H10 <i>New!</i>	540 x 273
CBDS24H10 <i>New!</i>	610 x 273

Case Pack: 1
Color: Brushed Graphite (580).

Shelf Traverses

Available in single or double packs. Use a single set to add an open shelf for divider bars or drying racks. Add single traverses onto back posts for extra support when placing rolling equipment under the first shelf. Traverse dovetails included.



LENGTH	SINGLE PACK CODE*	DOUBLE PACK CODE**
765 mm	CBTR30	—
915	CBTR36	CBTR362PK
1070	CBTR42	CBTR422PK
1220	CBTR48	CBTR482PK
1375	CBTR54	CBTR542PK
1525	CBTR60	CBTR602PK

*Case Pack: 1 **Case Pack: 2
Color: Brushed Graphite (580).

CAMSHELVING® BASICS SERIES ACCESSORIES

Corner Connectors

Unique patented design ensures maximum shelf space utilization. Use 1 set per shelf to connect starter and add-on units in corners. Connect 4 or 5 intermediate shelves between 2 starter units (2 sets required per shelf). Available as a single set or 8 or 10 set packs.

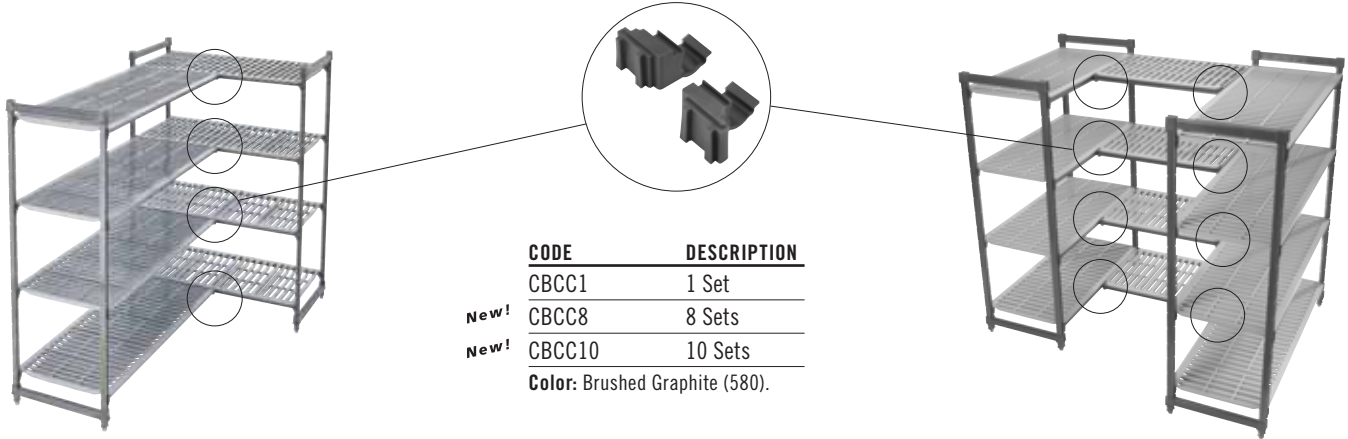

	CODE	DESCRIPTION
	CBCC1	1 Set
New!	CBCC8	8 Sets
New!	CBCC10	10 Sets
	Color: Brushed Graphite (580).	

Identification Tag

Clip onto shelf traverses to clearly identify stored product. Made of highly durable plastic with a clear slide in front panel. Labels included.

CODE	DESCRIPTION	DIMENSION L x H
CBID6	152 mm ID Tag	152 x 25 mm
Case Pack: 12 Color: White / Clear.		



Wall Fastener

Use to secure stationary shelving unit to a wall for added safety and stability where required. Made of stainless steel. Screws not included.

CODE	DIMENSION D x L x H
CSWF	73 x 238 x 48 mm
Case Pack: 4 Color: Silver (000).	



Hole diameter 1,11 cm



Seismic Foot

Secure stationary unit posts directly to the floor for added safety and stability where required. Made of stainless steel. Bolts not included.

CODE	DIMENSION D x L x H
CSEQ3	102 x 83 x 59 mm
Case Pack: 4 Color: Silver (000).	



Hole diameter 1,43 cm



Shelf Divider

Stack and separate items stored on shelves. Made of highly durable ABS plastic. Installs directly into solid or vented shelves. Easily removable for relocating or washing.

CODE	DIMENSION D x H
CSSD188	460 x 203 mm
CSSD218	540 x 203
CSSD248	610 x 203
Case Pack: 1 Color: Soft Grey (151).	



CAMSHELVING® BASICS SERIES ACCESSORIES

Tray Sliding Rack (for 610 mm deep shelf only)

Holds up to 6 each full size (1826)
46 x 66 cm or 12 half size (1318)
32 x 45 cm sheet pans or trays.
Install 1 or more units onto vented
shelves, any length. High quality,
lightweight aluminum material is
safe for use in coolers and freezers.
Made from aluminum 6463
(6000 series).

CODE	DIMENSION D x L x H
CSTSR	584 x 517 x 508 mm
Case Pack: 1 Color: Silver (000).	

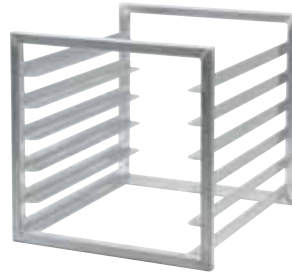

Single Shelf Security Cage (for 610 mm deep shelf only)

Securely store valuable products on
a single shelf. Made of heavy duty,
304 stainless steel for use in any
environment. Requires 457 mm height
between shelves. Install on vented
shelves only. Lock not included.

CODE	DIMENSION D x L x H
CSSC244818	640 x 1080 x 457 mm
Case Pack: 1 Color: Silver (000).	



Vertical Drying and Storage Cradle (for 610 mm deep shelf only)

Modular 7-slot rack designed for
drying and storing trays, sheet pans,
cutting boards and lids. Installs
directly onto shelf traverses. Made of
highly durable ABS plastic. Available
in single or 3 pack.

CODE	DIMENSIONS D x L x H	CASE PACK
CSDR7	597 x 260 x 95 mm	1
CSDR73	597 x 260 x 95	3
Color: Soft Grey (151).		



Dome Drying and Storage Cradle (for 540 mm deep shelf only)

Use to dry and safely store up to
10 patient meal delivery domes or
plate covers upright. Installs directly
onto shelf traverses. Made of highly
durable ABS plastic. Available in
single or 5 pack.

CODE	DIMENSIONS D x L x H	CASE PACK
CSDDC	520 x 415 x 86 mm	1
CSDDC5	520 x 415 x 86	5
Color: Soft Grey (151).		



Angled Drying and Storage Cradle (for 610 mm deep shelf only)

Uniquely designed cradle holds up to
8 each meal delivery pellets or
use to dry, store and transport food
pans and other commercial kitchen
ware. Installs directly onto shelf
traverses. Made of highly durable
ABS plastic. Available in single or
4 pack.

CODE	DIMENSIONS D x L x H	CASE PACK
CSDR8	592 x 263 x 160 mm	1
CSDR84	592 x 263 x 160	4
Color: Soft Grey (151).		



CAMSHELVING® WALL SHELVES AND SHELF EXTENDERS

Wall Shelves

- Expand storage space in kitchens, above work stations and sinks.
- Features virtually indestructible I-beam supports that hold up to 68 kg per shelf.
- Durable polypropylene withstands temperatures up to 88°C, and will not rust or corrode.
- Snap fit rail design allows shelves to snap on and off for easy cleaning.
- 5 cm backsplash and marine front edge controls spills and cross contamination.

Shelf Extenders

- Convert empty wall space into a functional storage area.
- Use with or without Camshelving Wall Shelves.
- Peg strips withstand temperatures up to 88°C, and will not rust or corrode

Wall Shelf Color: Speckled Grey (480).

Extender Peg Strip Color: Black (110).



Shelf Extenders ship in one carton and include:

	PEG		
LENGTH	STRIPS	BRACKETS	HOOKS
910 mm	3	2	6
1220 mm	3	3	9



CODE	CSWS1436SK	CSWS1448SK	CSWS1436VK	CSWS1448VK
DESCRIPTION	910 mm wall shelf, solid	1220 mm wall shelf, solid	910 mm wall shelf, vented	1220 mm wall shelf, vented
EXTERIOR DIMENSIONS	L 915 x D 360 x H 340 mm	L 1220 x D 360 x H 340 mm	L 915 x D 360 x H 340 mm	L 1220 x D 360 x H 340 mm

Case Pack: 1



CODE	CSWS1836SK	CSWS1848SK
DESCRIPTION	910 mm wall shelf, solid	1220 mm wall shelf, solid
EXTERIOR DIMENSIONS	L 915 x D 460 x H 340 mm	L 1220 x D 460 x H 340 mm

Case Pack: 1

CODE	CSWS36EK	CSWS48EK
DESCRIPTION	910 mm Shelf Extender	1220 mm Shelf Extender
EXTERIOR DIMENSIONS	L 900 x D 50 x H 390 mm	L 1220 x D 50 x H 390 mm

Case Pack: 1

S-SERIES DUNNAGE RACKS AND CAMLINK®



S-Series Dunnage Racks

- Keep frozen, cold or dry inventory 30,5 cm safely off the floor.
- One piece construction and sturdy legs provide strength and stability.
- Heavy duty polypropylene is safe to -38°C, and will not rust, corrode or bend.
- Choose slotted tops for maximum air circulation around perishable products.
- Solid tops catch spills for easy clean up.

Colors: Dark Brown (131),
Speckled Gray (480).



CODE	EXTERIOR DIM. H x D x W	LOAD CAPACITY
Solid Top		
DRS30	300 x 533 x 760 mm	680 kg
DRS36	300 x 533 x 915	680
DRS48	300 x 533 x 1220	1,360
DRS60	300 x 533 x 1525	1,360
Slotted Top		
DRS300	300 x 533 x 760	680
DRS360	300 x 533 x 915	680
DRS480	300 x 533 x 1220	1,360
DRS600	300 x 533 x 1525	1,360

Case Pack: 1

Camlink

Camlink connectors securely lock dunnage racks together for greater stability.



CODE	CASE PACK
DRLNK	6

Color: Black (110).

Camlink fits all sizes and styles. One free Camlink supplied with every Dunnage Rack.





CAMBRO

Supplies

FOOD STORAGE &
PREPARATION

TABLE SERVICE

FOOD PRESENTATION

TRAYS



FOOD STORAGE & PREPARATION

Quick Guide To Storage Solutions

Polycarbonate CamSquare® Food Storage Containers

Polycarbonate Round Food Storage Containers

Polycarbonate Food Storage Boxes

Polycarbonate Food Pans

Polycarbonate Colander Pans

H-Pans™ High Heat Food Pans

H-Pan™ Colander Pans

Translucent Polypropylene Gastronorm Food Pans

ColdFest® Gastronorm Food Pans,
Crocks, Covers & Pumps

StoreSafe® Food Rotation Labels

Pizza Dough Boxes

Ingredient Bins & Camcrisper®

Polycarbonate Scoops & Measuring Cups



QUICK GUIDE TO STORAGE SOLUTIONS



STORAGE CONTAINERS

CamSquares® Food Storage Containers

Keeps food fresh and maximizes storage areas.



7	3	2
SIZES	MATERIALS	LID TYPES

COLDVEST®

GN Pans

Holds cold food at safe temperatures without ice for hours.



4	1	1	5
SIZES	DEPTH	MATERIAL	LID TYPES

Round Food Storage Containers

Store ingredients or transport ready to serve or partially prepared foods.



8	3	4
SIZES	MATERIALS	LID TYPES

INGREDIENT BINS

Store dry bulk ingredients such as flour and grain.



6	1	3
CAPACITIES	COLOR	LID TYPES

FOOD STORAGE BOXES

Safely store bulk produce, meat, poultry and seafood.



2	5	2	2
SIZES	DEPTHS	MATERIALS	LID TYPES



MATERIALS

Polycarbonate

Virtually unbreakable polycarbonate material will not crack, bend or dent. Withstands temperatures from -40° to 99°C.

High Heat H-Pans™

High heat material is safe for use in microwaves, ovens and steam tables. Withstands extreme temperatures from -40° to 149°C.

Polypropylene

Translucent polypropylene material provides a high chemical resistance. Withstands temperatures from -40° to 70°C.

Polyethylene

High chemical and impact resistant material. Withstands temperatures from -40° to 70°C.

ABS

High-performance and impact resistant material. Ideal for temperatures at or below 4°C.

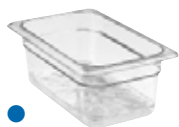

FOOD PANS

Polycarbonate Food Pans

Store, transport and serve all in one pan. Virtually unbreakable polycarbonate will not crack, bend or dent. Withstands temperatures from -40° to 99°C.



7 SIZES	4 DEPTHS	3 COLORS	7 LID TYPES
------------	-------------	-------------	----------------

Translucent Food Pans

An economical choice for storage and serving. Ideal for use in cold and ambient environments. Withstands temperatures from -40° to 70°C.



6 SIZES	2 DEPTHS	1 COLOR	4 LID TYPES
------------	-------------	------------	----------------

High Heat H-Pans™

Pans can go from prep to cooler to oven to steam table. Withstands temperatures from -40° to 149°C.



7 SIZES	3 DEPTHS	2 COLORS	7 LID TYPES
------------	-------------	-------------	----------------

Colander Pans

Liquids drain away from food into the pan below for enhanced food quality and improved food safety.

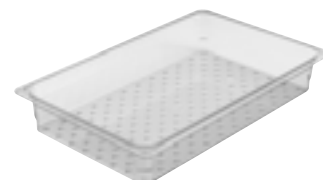

4 SIZES	2 DEPTHS	2 MATERIALS	3 LID TYPES
------------	-------------	----------------	----------------

FOOD PAN LIDS

Covers protect contents better than plastic wrap or foil while saving time and money. Lids improve food safety and extend product freshness. Fit selected Polycarbonate, High Heat and Poly Food Pans.

Flat Cover

Basic cover available in all pan sizes.



Notched FlipLid

FlipLid with notch to rest spoon in contents with lid closed.



Cover with Handle

Deep molded handle provides secure grip. Available in Black and Clear.



Seal Cover for Polycarbonate and Translucent Food Pans

Translucent seal covers provides an inner and outer seal, to protect food quality while eliminating the expense of plastic wrap.



Notched Cover with Handle

Notched cover allows utensils to remain in pan and off of potentially contaminated counters.



GripLid®

Lid grips the side of the pan, reducing spills and points of cross contamination. Fits Polycarbonate and High Heat pans.



FlipLid®

Keeps contents covered yet flips up easily for service.



POLYCARBONATE CAMSQUARE® FOOD STORAGE CONTAINERS



Maximize your storage area with CamSquare food storage containers. The square shape provides 33% better space usage than traditional round containers. Clear polycarbonate provides product visibility for at a glance inventory management. Seal covers feature an inner and outer seal for superior spill resistance, even during transport.

Note: All graduations are approximate.

Dimensions include handles.



Tight fitting Seal Cover is spill resistant, saves expense & safer for employees to handle during transport.

Interstacking saves space when not in use.

Wide molded-in handles ease carrying larger size. Molded-in holes offer quick and sanitary drying.

Crystal clear, virtually unbreakable polycarbonate withstands temperatures from -40° to 99°C.

Stain and odor resistant.

Easy to read graduations printed on the outside for quick inventory management.



Seal Covers for Polycarbonate CamSquare*

- Inner and outer seal provide excellent spill resistance.
- Includes a hole on the corner for hanging during storage.
- Translucent lid easily identifies contents.
- Withstands temperatures from -40° to 70°C.

* Seal covers only fit Polycarbonate Square Containers.



CAMSQUARE® TRANSLUCENT POLYPROPYLENE & POLYETHYLENE FOOD STORAGE CONTAINERS

Translucent Polypropylene

Note: All graduations are approximate.



- Translucent material provides some content visibility and high chemical resistance.
- Withstands temperatures from -40° to 70°C.
- Easy to read graduations are printed on the outside for at a glance inventory management.



Polyethylene

Note: All graduations are approximate.



- Economical storage choice.
- Made of impact, stain and chemical resistant material.
- Withstands temperatures from -40° to 70°C.



Covers for CamSquares

- Snap-tight polyethylene covers feature thumb tabs for easy removal.
- Poly covers fit Polycarbonate, Translucent and Polyethylene CamSquare Containers.



Personalized Storage Products

Personalize food storage products to identify menu items, add fill lines for recipes, or use personalization in multiple languages to help ensure product quality and consistency.



POLYCARBONATE CAMSQUARE® FOOD STORAGE CONTAINERS



Polycarbonate



CODE	2SFSCW	4SFSCW	6SFSCW	8SFSCW	12SFSCW**	18SFSCW**	22SFSCW**
CAPACITY	1,9 L	3,8 L	5,7 L	7,6 L	11,4 L	17,2 L	20,8 L
DIM. L x W x H	18,5 x 18,5 x 10 cm	18,5 x 18,5 x 18,7 cm	21,5 x 21,5 x 18,5 cm	21,5 x 21,5 x 23 cm	25,6 x 31 x 21 cm	25,6 x 31 x 32 cm	25,6 x 31 x 40 cm

Case Pack: 6 Color: Clear (135). Height includes covers. ** Dimensions include handles.

Seal Covers for Polycarbonate CamSquare*



CODE	SFC2SCPP	SFC6SCPP	SFC12SCPP
DESCRIPTION	Fits 1,9 & 3,8 L	Fits 5,7 & 7,6 L	Fits 11,4, 17,2 & 20,8 L

Case Pack: 6 Color: Translucent (190).

Note: All graduations are approximate.

* Seal Covers only fit Polycarbonate CamSquare containers.

Personalization available on non-food contact areas only. See crestring section for information, ordering and pricing.



2
PRORATED

CAMSQUARE® TRANSLUCENT POLYPROPYLENE & POLYETHYLENE FOOD STORAGE CONTAINERS



Translucent Polypropylene



CODE	2SFSP	4SFSP	6SFSP	8SFSP	12SFSP**	18SFSP**	22SFSP**
CAPACITY	1,9 L	3,8 L	5,7 L	7,6 L	11,4 L	17,2 L	20,8 L
DIM. L x W x H	18,5 x 18,5 x 10 cm	18,5 x 18,5 x 18,7 cm	21,5 x 21,5 x 18,5 cm	21,5 x 21,5 x 23 cm	25,6 x 31 x 21 cm	25,6 x 31 x 32 cm	25,6 x 31 x 40 cm
Case Pack: 6	Color: Translucent (190). Height includes covers. ** Dimensions include handles.						

Polyethylene



CODE	2SFSP	4SFSP	6SFSP	8SFSP	12SFSP**	18SFSP**	22SFSP**
CAPACITY	1,9 L	3,8 L	5,7 L	7,6 L	11,4 L	17,2 L	20,8 L
DIM. L x W x H	18,5 x 18,5 x 10 cm	18,5 x 18,5 x 18,7 cm	21,5 x 21,5 x 18,5 cm	21,5 x 21,5 x 23 cm	25,6 x 31 x 21 cm	25,6 x 31 x 32 cm	25,6 x 31 x 40 cm
Case Pack: 6	Color: Natural White (148). Height includes covers. ** Dimensions include handles.						

Covers*



CODE	SFC2	SFC6	SFC12
COLOR	Kelly Green (452)	Winter Rose (451)	Midnight Blue (453)
DESCRIPTION	Fits 1,9 & 3,8 L	Fits 5,7 & 7,6 L	Fits 11,4, 17,2 & 20,8 L
Case Pack: 6			

Note: All graduations are approximate.

* Poly Covers fit Polycarbonate, Translucent and Polyethylene CamSquare Containers.

Personalization available on non-food contact areas only. See cresting section for information, ordering and pricing.



POLYCARBONATE ROUND FOOD STORAGE CONTAINERS

Store ingredients or transport ready to serve or partially prepared foods. Clear polycarbonate allows for easy content identification at a glance. Reduces risk of contamination and enhances food safety. Round shape promotes proper air circulation, ideal for stirring soups and sauces.

Note: All graduations are approximate.

Note: To order Round Food Storage Containers without imprinted graduations, simply add "N" to the end of the code number.

Lids are not interchangeable.



2
PRORATED



Seal Cover provides excellent spill resistance.

Crystal clear, virtually unbreakable polycarbonate withstands temperatures from -40° to 99°C.

Molded-in handles ease carrying. Molded-in holes offer quick and sanitary drying.



Interstacking saves space when not in use.

Resists food acids, oils & alcohol. Stain and odor resistant.

Easy to read graduations on the outside for at a glance inventory management.

Polycarbonate Covers

- Snap on covers fit tightly.
- Stain resistant to food acids and oils.
- Withstands temperatures from -40° to 99°C.



Round Seal Covers

- Inner and outer seal provide excellent spill resistance.
- Safe from -40° to 70°C.
- Thumb tab for easy removal.

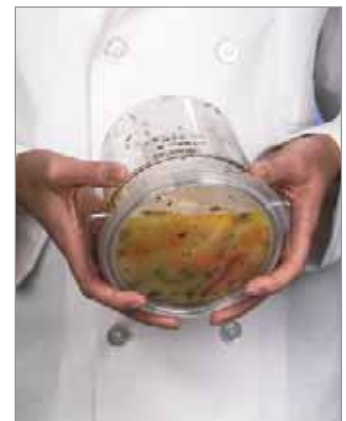

TRANSLUCENT POLYPROPYLENE & POLYETHYLENE ROUND FOOD STORAGE CONTAINERS

Translucent Polypropylene

- Translucent material offers some product visibility.
- Rounds are durable and resistant to stains.
- Withstands temperatures from -40° to 70°C.
- Snap on covers fit tightly to protect contents and extend product freshness.

Note: All graduations are approximate.
.....
Note: To order Round Food Storage Containers without imprinted graduations, simply add "N" to the end of the code number.
.....
Lids are not interchangeable.



Polyethylene

- Impact, stain and chemical resistant material.
- An affordable storage choice.
- Safe from -40° to 70°C.
- Snap on covers fit tightly yet are easily removed.

Note: All graduations are approximate.
.....
Note: To order Round Food Storage Containers without imprinted graduations, simply add "N" to the end of the code number.
.....
Lids are not interchangeable.



POLYCARBONATE ROUND STORAGE CONTAINERS



Polycarbonate



CODE	RFSCW1	RFSCW2	RFSCW4	RFSCW6	RFSCW8	RFSCW12	RFSCW18	RFSCW22
CAPACITY	0,9 L	1,9 L	3,8 L	5,7 L	7,6 L	11,4 L	17,2 L	20,8 L
TOP DIAMETER	15,4 cm	20,8 cm	20,8 cm	25,2 cm	25,2 cm	37,8 cm	37,8 cm	37,8 cm
HEIGHT	12,7 cm	11,1 cm	21,8 cm	20,2 cm	27,6 cm	21,3 cm	30,5 cm	38,1 cm
CASE PACK	12	12	12	12	12	6	6	6

Color: Clear (135). Top diameter dimension includes handle. Height dimension includes cover. Two year warranty on Polycarbonate Rounds.



Polycarbonate Covers

DESCRIPTION	CASE PACK	CODE
Fits 0,9 L	12	RFSCWC1
Fits 1,9 L & 3,8 L	12	RFSCWC2
Fits 5,7 L & 7,6 L	12	RFSCWC6
Fits 11,4 L, 17,2 L & 20,8 L	6	RFSCWC12

Color: Clear (135).

Seal Covers for Polycarbonate Rounds

DESCRIPTION	CASE PACK	CODE
Fits 0,9 L	12	RFS1SCPP
Fits 1,9 L & 3,8 L	12	RFS2SCPP
Fits 5,7 L & 7,6 L	12	RFS6SCPP
Fits 11,4 L, 17,2 L & 20,8 L	6	RFS12SCPP

Color: Translucent (190).

TRANSLUCENT POLYPROPYLENE & POLYETHYLENE ROUND FOOD STORAGE CONTAINERS



Translucent Polypropylene



CODE	RFS1PP	RFS2PP	RFS4PP	RFS6PP	RFS8PP	RFS12PP	RFS18PP	RFS22PP
CAPACITY	0,9 L	1,9 L	3,8 L	5,7 L	7,6 L	11,4 L	17,2 L	20,8 L
TOP DIAMETER	15,4 cm	20,8 cm	20,8 cm	25,2 cm	25,2 cm	37,8 cm	37,8 cm	37,8 cm
HEIGHT	12,7 cm	11,1 cm	21,8 cm	20,2 cm	27,6 cm	21,3 cm	30,5 cm	38,1 cm
CASE PACK	12	12	12	12	12	6	6	6

Color: Translucent (190). Top diameter dimension includes handle. Height dimension includes cover.

Polyethylene



CODE	RFS1	RFS2	RFS4	RFS6	RFS8	RFS12	RFS18	RFS22
CAPACITY	0,9 L	1,9 L	3,8 L	5,7 L	7,6 L	11,4 L	17,2 L	20,8 L
TOP DIAMETER	15,4 cm	20,8 cm	20,8 cm	25,2 cm	25,2 cm	37,8 cm	37,8 cm	37,8 cm
HEIGHT	12,7 cm	11,1 cm	21,8 cm	20,2 cm	27,6 cm	21,3 cm	30,5 cm	38,1 cm
CASE PACK	12	12	12	12	12	6	6	6

Color: Natural White (148). Top diameter dimension includes handle. Height dimension includes cover.

Covers for Translucent Polypropylene Rounds

DESCRIPTION	CASE PACK	CODE
Fits 0,9 L	12	RFSC1PP
Fits 1,9 L & 3,8 L	12	RFSC2PP
Fits 5,7 L & 7,6 L	12	RFSC6PP
Fits 11,4 L, 17,2 L & 20,8 L	6	RFSC12PP

Color: Translucent (190).

Covers for Polyethylene Rounds

DESCRIPTION	CASE PACK	CODE
Fits 0,9 L	12	RFSC1
Fits 1,9 L & 3,8 L	12	RFSC2
Fits 5,7 L & 7,6 L	12	RFSC6
Fits 11,4 L, 17,2 L & 20,8 L	6	RFSC12

Color: Natural White (148).

POLYCARBONATE FOOD STORAGE BOXES



ELIMINATE THE HAZARD OF CROSS CONTAMINATION

Extend the freshness of ingredients and eliminate points of cross contamination by transferring product into food boxes at the receiving dock. A safe solution for storing bulk fruits and vegetables. Clear polycarbonate allows visibility for product identification. Snap tight polycarbonate covers or SlidingLids™, sold separately, won't come off during transportation.

Polycarbonate and Poly Lids are not interchangeable.

SlidingLids are covered by the following U.S. Patents D 447,906 S & 6,540,098 B1.

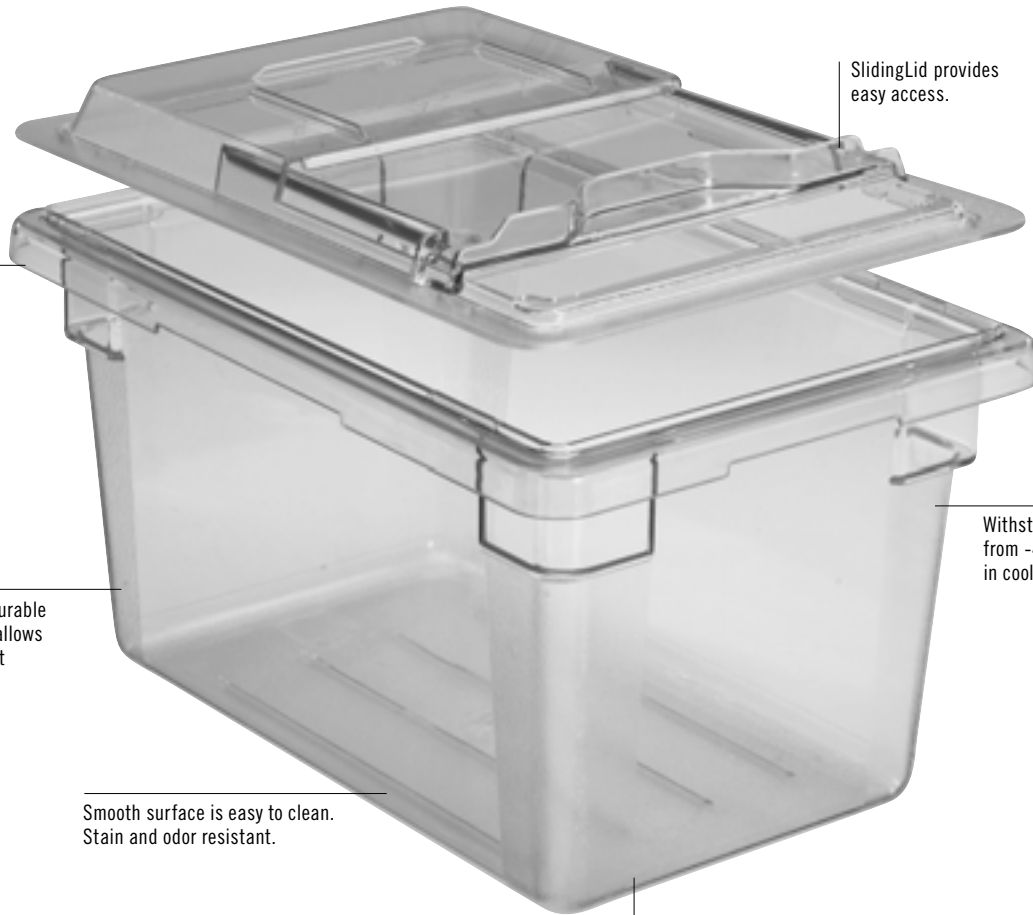

Molded-in handles ease carrying.

SlidingLid provides easy access.

Crystal clear, durable polycarbonate allows for easy product identification.

Withstands temperatures from -40° to 99°C for use in coolers and freezers.

Smooth surface is easy to clean. Stain and odor resistant.

Texturing on bottom of boxes reduces scratching.

Polycarbonate Flat Lids

- Snap-tight covers won't come off during transport.
- Top molded-in rails for safer, more secure stacking.
- Durable polycarbonate is safe from -40° to 99°C.



Polycarbonate SlidingLids fits Polycarbonate Food Storage Boxes

- Lid slides back to easily access contents, minimizing handling.
- Reduces the risk of cross contamination since lid remains on food box.
- Made of virtually unbreakable polycarbonate.



POLYCARBONATE & POLYETHYLENE FOOD STORAGE BOXES

Polycarbonate ColanderKits™

- A complete food safety system packaged in one carton.
- Store raw meats, fish on ice or bulk produce safely.
- Juices and liquids drip into the food box below for quick and easy disposal.

- Reduces handling and risk of cross contamination.
- Kit consists of 1 each of 18269CW food box, 1 each 18268CLRCW colander, and 1 each 1826SCCW sliding lid.



Polycarbonate Colanders

- Enhances food quality and reduces risk of cross contamination.
- Liquids and juices drain directly into food box for improved food safety.
- Ideal for draining fruits and vegetables, thawing meat or poultry, or storing seafood on ice.

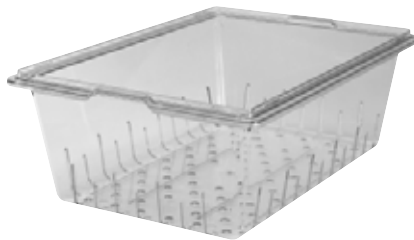

Polycarbonate Drain Shelves

- Lifts contents out of liquids to enhance food quality and freshness.
- Made of virtually unbreakable polycarbonate.
- Polycarbonate drain shelves fit in both polycarbonate boxes and white poly boxes.



Polyethylene Food Storage Boxes

- Economical choice for storing bulk produce and ingredients.
- Impact, stain and chemical resistant material.
- Withstands temperatures from -40° to 70°C.



Polycarbonate Safety Red and Yellow Food Storage Boxes

- Helps prevent cross-contamination between raw meats, poultry and other food products.
- Red and Translucent yellow color clearly identifies product inside.
- Matching flat cover also available.



POLYCARBONATE FOOD STORAGE BOXES



Polycarbonate



CODE	18263CW	⚡● 18266CW	18269CW
DIMENSIONS	46 x 66 x 9 cm	46 x 66 x 15 cm	46 x 66 x 23 cm
APPROX. CAPACITY	18,9 L	33,1 L	49,2 L
CASE PACK	6	6	4



CODE	182612CW	182615CW	12183CW	⚡● 12186CW	⚡ 12189CW
DIMENSIONS	46 x 66 x 30 cm	46 x 66 x 38 cm	30,5 x 46 x 9 cm	30,5 x 46 x 15 cm	30,5 x 46 x 23 cm
APPROX. CAPACITY	64,4 L	83,3 L	6,6 L	11,4 L	18 L
CASE PACK	4	3	6	6	6

Color: Clear (135). 18266CW & 12186CW available in: ● Safety Red (467), ⚡ Safety Yellow (464).

Polycarbonate Covers



CODE	⚡● 1826CCW FLAT LID	1826SCCW SLIDINGLID	⚡● 1218CCW FLAT LID	1218SCCW SLIDINGLID™
DIMENSIONS	45,7 x 66 cm	45,7 x 66 cm	30,5 x 45,7 cm	30,5 x 45,7 cm

Case Pack: 6 Color: Clear (135). 1826CCW & 1218CCW available in: ● Safety Red (467), ⚡ Safety Yellow (464).

POLYETHYLENE FOOD STORAGE BOXES & POLYCARBONATE ACCESSORIES



Polyethylene Boxes



CODE	18263P	18266P	18269P
DIMENSIONS	46 x 66 x 9 cm	46 x 66 x 15 cm	46 x 66 x 23 cm
APPROX. CAPACITY	18,9 L	33,1 L	49,2 L
CASE PACK	6	6	6



CODE	182612P	182615P	12183P	12186P	12189P
DIMENSIONS	46 x 66 x 30 cm	46 x 66 x 38 cm	30,5 x 46 x 9 cm	30,5 x 46 x 15 cm	30,5 x 46 x 23 cm
APPROX. CAPACITY	64,4 L	83,3 L	6,6 L	11,4 L	18 L
CASE PACK	4	3	6	6	6

Color: Natural White (148).

Polyethylene Covers



CODE	1826CP FLAT LID	1218CP FLAT LID
DIMENSIONS	45,7 x 66 cm	30,5 x 45,7 cm

Polycarbonate and Polyethylene Lids are not interchangeable.

Color: Natural White (148). Case Pack: 6

Accessories



CODE	1826DSCW	1218DSCW	1826CLRCW (12,7 CM DEEP)	18268CLRCW (20 CM DEEP)	18268CLRKIT
DESCRIPTION	Drain shelf	Drain shelf	Colander	Colander	ColanderKit™
DIMENSIONS	Fits 46 x 66 cm food storage boxes	Fits 30,5 x 46 cm food storage boxes	Fits polycarbonate food storage boxes 46 x 66 x 15 cm and deeper	Fits polycarbonate food storage boxes 46 x 66 x 23 and deeper	One 20 cm deep colander one 46 x 66 x 23 cm food box one 46 x 66 cm SlidingLid™
CASE PACK	6	6	6	4	1 Kit

Color: Clear (135).

POLYCARBONATE FOOD PANS



Store, transport and serve all in one pan. Polycarbonate food pans are made from durable polycarbonate that will not crack, bend or dent. Precisely designed to Gastronorm GN specifications, with a bottom to reduce food waste. At half the cost of stainless steel, polycarbonate polycarbonate pans keep contents as cold as metal pans with less condensation. Pans stack neatly without wedging or sticking.

Polycarbonate GN pans are not recommended for steam table or microwave use. See H-Pan™ section for these high heat applications.

Colander Pan is covered by U.S. Patent D 528,376 S.



Uniform 1,27 cm flange ensures a smooth fit in prep tables and food bars.

Virtually unbreakable polycarbonate withstands temperatures from -40° to 99°C.

Molded-in graduations in standard and metric for easy inventory management.

Won't react with food; minimizes potentially hazardous chemical or acidic reaction.



Non-stick smooth interior surface increases yields and promotes easy cleaning.

Textured bottoms resist scratching.

Cold Test

Tests prove polycarbonate food pans keep products as cold as stainless steel. Stainless steel may feel colder, but as these test results demonstrate, polycarbonate food pans keep products just as cold for just as long.

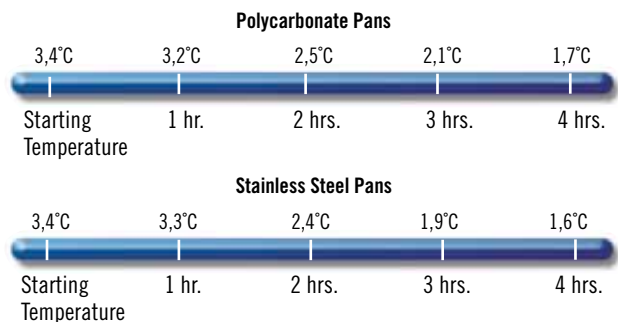

POLYCARBONATE GASTRONORM FOOD PANS SIZE, & ORDERING INFORMATION

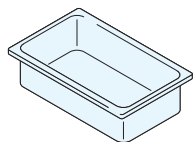

CONFIGURATIONS	PAN CODE	PAN DEPTH	APPROXIMATE CAPACITY
GN 1/1 32,5 x 53 cm	12CW	6,5 cm	8,5 L
	14CW	10	13
	16CW	15	19,5
	18CW	20	25,6
	10CWD	—	Drain shelf

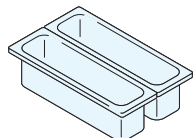

GN 1/2 Long 16,2 x 53 cm	22LPCW	6,5	3
	24LPCW	10	5
	20LPCWD	—	Drain shelf

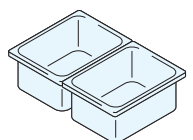

GN 1/2 26,5 x 32,5 cm	22CW	6,5	3,9
	24CW	10	5,9
	26CW	15	8,9
	28CW	20	11,7
	20CWD	—	Drain shelf

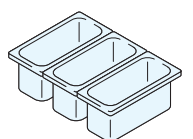

GN 1/3 17,6 x 32,5 cm	32CW	6,5	2,4
	34CW	10	3,6
	36CW	15	5,3
	38CW	20	6,9
	30CWD	—	Drain shelf

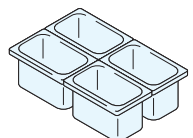

GN 1/4 16,2 x 26,5 cm	42CW	6,5	1,7
	44CW	10	2,5
	46CW	15	3,7
	40CWD	—	Drain shelf

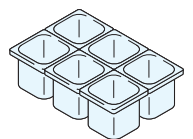

GN 1/6 16,2 x 17,6 cm	62CW	6,5	1
	64CW	10	1,5
	66CW	15	2,2
	60CWD	—	Drain shelf

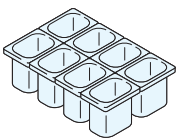

GN 1/8 16,12 x 13,17 cm	82CW New!	6,5	0,7
	84CW New!	10	1
	86CW New!	15	1,5
	80CWD New!	—	Drain shelf

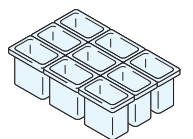

GN 1/9 10,8 x 17,6 cm	92CW	6,5	0,57
	94CW	10	0,85
	90CWD	—	Drain shelf

Case Pack for all Pans: 6. Lids listed on following page.
See next page for colanders.

Colors: Clear (135), White (148), Black (110). 18CW and 28CW available in Clear (135) only.

Drain Shelf Color: Clear (135).
Colander Color: Clear (135).

All Polycarbonate GN Food Pans are made of FDA approved materials. All Polycarbonate GN Food Pans are designed to CEN Gastronorm Standard EN 631-1.

Personalization available on non-food contact areas only. See cresting section for information and ordering.



PRORATED

Drain Shelves

- Support products and promotes drainage.
- Available to fit all pan sizes.

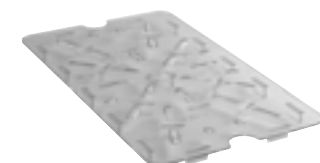

POLYCARBONATE COLANDER PANS



- Rinse, drain and store all in one pan.
- Liquids drain easily into the food pan below for enhanced food quality and reduced handling.
- Colanders simply lift out of the food pan for safe and quick disposal of liquids.
- Ideal for prepped produce, storing seafood on ice, and defrosting and storing meats and poultry.
- Polycarbonate flat covers, covers with handles and notched covers with handles fit on pans with colanders.

Colander Pans are covered by U.S. Patent D 569,169 S.



13CLRCW



Rinse



Drain



Store

CONFIGURATIONS	PAN CODE	COLANDER DEPTH	FITS POLYCARBONATE PAN DEPTH*
GN 1/1 32,5 x 53 cm	13CLRCW	7,6 cm	10 cm
	15CLRCW	12,7	15
GN 1/2 26,5 x 32,5 cm	23CLRCW	7,6	10
	25CLRCW	12,7	15
GN 1/3 17,6 x 32,5 cm	33CLRCW	7,6	10
	35CLRCW	12,7	15
GN 1/6 16,2 x 17,6 cm	63CLRCW	7,6	10
	65CLRCW	12,7	15

Case Pack for all Pans: 6 Lids listed on following page. * Fits this pan depth & deeper.



POLYCARBONATE LID SIZES & ORDERING INFORMATION



Flat Cover

Available in all pan sizes.



Cover with Handle

Deep molded handle provides secure grip. Also available in black to help block light, reducing discoloration of meats and cheeses. Helps maintain freshness.

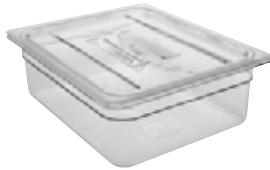

Notched Cover with Handle

Easy access for ladles or spoons.



Seal Cover

Designed to fit Camwear polycarbonate and translucent Food Pans, our new Seal Covers feature an inner seal that provides superior spill resistance and maximizes product freshness.

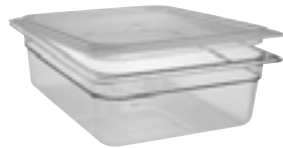

FlipLid®

Flip up lid to easily access contents. Food can be held without getting dried out, increasing yields. Reduces points of cross contamination.



Notched FlipLid

Flip Lid with notch to rest spoon in contents with lid closed.



GripLid®

Molded-in polyurethane gasket on the lid grips the side of the food pan, reducing spills and points of cross-contamination.



FITS PANS	LID CODE	DESCRIPTION
GN 1/1 32,5 x 53 cm	10CWC	Flat cover
	10CWCH	Cover with handle
	10CWCHN	Notched cover with handle
	10CWGL	GripLid
	10PPCWSC	Seal cover
GN 1/2 Long 16,2 x 53 cm	20LPCWC	Flat cover
GN 1/2 26,5 x 32,5 cm	20CWC	Flat cover
	20CWCH	Cover with handle
	20CWCHN	Notched cover with handle
	20CWL	FlipLid
	20CWLN	Notched FlipLid
	20CWGL	GripLid
	20PPCWSC	Seal cover
GN 1/3 17,6 x 32,5 cm	30CWC	Flat cover
	30CWCH	Cover with handle
	30CWCHN	Notched cover with handle
	30CWL	FlipLid
	30CWLN	Notched FlipLid
	30CWGL	GripLid
	30PPCWSC	Seal cover
GN 1/4 16,2 x 26,5 cm	40CWC	Flat cover
	40CWCH	Cover with handle
	40CWCHN	Notched cover with handle
	40PPCWSC	Seal cover
GN 1/6 16,2 x 17,6 cm	60CWC	Flat cover
	60CWCH	Cover with handle
	60CWCHN	Notched cover with handle
	60CWL	FlipLid
	60CWLN	Notched FlipLid
	60CWGL	GripLid
	60PPCWSC	Seal cover
GN 1/8 16,12 x 13,17 cm	80CWC New!	Flat cover
	80CWCH New!	Cover with handle
	80CWCHN New!	Notched cover with handle
	80PPCWSC New!	Seal cover
GN 1/9 10,8 x 17,6 cm	90CWC	Flat cover
	90CWCN	Flat notched cover
	90PPCWSC	Seal cover

Case pack for all lids: 6

Color: Clear (135).

Seal Cover Color: Sheer Blue (438).

Cover with Handle Colors: Clear (135), Black (110).

Personalization available on non-food contact areas only. See cresting section for information and ordering.

FlipLids are covered by U.S. Patent Des. 420,849,422,838 & 427,012. GripLids are covered by U.S. Patent D 446,076 & Utility Patent 6,273,288 B1.



GASTRONORM HIGH HEAT H-PANS™

Reduce handling and save expense with one pan that can go from prep to cooler to oven to steam table. H-Pans are designed to Gastronorm GN specifications. Unlike metal pans, H-Pans are safe for use in heating and holding applications. Ideal for heated carts, steam tables and chafing dishes. H-Pans have both standard and metric graduation markings to promote easy inventory management.

Colors: Amber (150), Black (110).
.....
H-Pans are made of FDA approved materials and are designed to CEN Gastronorm Standard EN 631-1.
Amber color may vary.
.....

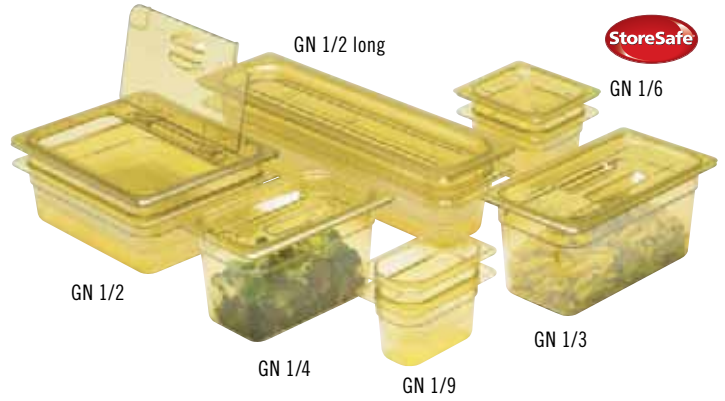

Uniform 1,27 cm flange ensures a smooth fit in prep tables and food bars.

Great for flash freezing and reheating.

Pans stack neatly, without wedging or sticking.



Non-stick smooth interior surface increases yields and promotes easy cleaning.

Made from FDA approved materials that withstand temperatures from -40° to 149°C.



GASTRONORM HIGH HEAT H-PANS™

SIZES & ORDERING INFORMATION

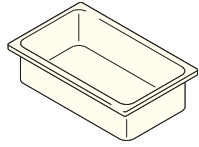

CONFIGURATIONS	PAN CODE	PAN DEPTH	APPROXIMATE CAPACITY
GN 1/1 32,5 x 53 cm	12HP	6,5 cm	8,5 L
	14HP	10	13
	16HP	15	19,5
	10HPD	—	Drain shelf

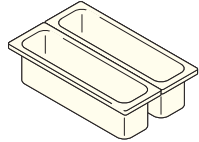

GN 1/2 Long 16,2 x 53 cm	22LPHP	6,5	3
	24LPHP	10	5
	20LPHPD	—	Drain shelf

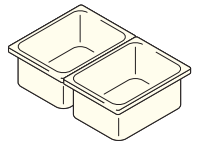

GN 1/2 26,5 x 32,5 cm	22HP	6,5	3,9
	24HP	10	5,9
	26HP	15	8,9
	20HPD	—	Drain shelf

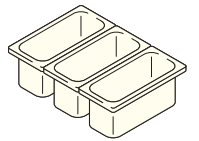

GN 1/3 17,6 x 32,5 cm	32HP	6,5	2,4
	34HP	10	3,6
	36HP	15	5,3
	30HPD	—	Drain shelf

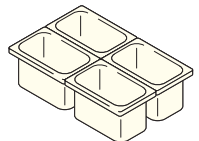

GN 1/4 16,2 x 26,5 cm	42HP	6,5	1,7
	44HP	10	2,5
	46HP	15	3,7
	40HPD	—	Drain shelf

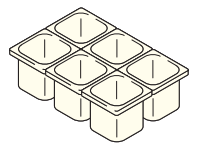

GN 1/6 16,2 x 17,6 cm	62HP	6,5	1
	64HP	10	1,5
	66HP	15	2,2
	60HPD	—	Drain shelf

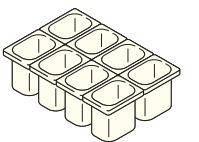

GN 1/8 16,12 x 13,17 cm	82HP New!	6,5	0,7
	84HP New!	10	1
	86HP New!	15	1,5
	80HPD New!	—	Drain shelf

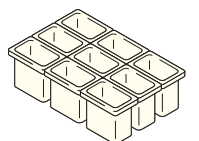

GN 1/9 10,8 x 17,6 cm	92HP	6,5	0,57
	94HP	10	0,85
	90HPD	—	Drain shelf

Colors: Amber (150), Black (110).
Drain Shelf Color: Amber (150).

H-Pans are made of FDA approved materials and are designed to CEN Gastronorm Standard EN 631-1. Amber color may vary.

Personalization available on non-food contact areas only. See cresting section for information and ordering.



Drain Shelf

- Supports product and promotes drainage.
- Available to fit all food pan sizes.

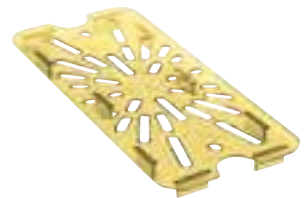

Case Pack: 6 Lids listed on following page.

See next page for colanders.

H-PAN™ COLANDER PANS

- Colanders drain liquids and grease away from hot foods, improving food quality.
- Ideal for reheating in microwaves and holding applications such as steam tables and buffet lines.
- Reduces handling and improves food safety.
- H-Pan flat covers, covers with handles and notched covers with handles fit on pans with colanders.



Steam



Hold Hot Foods



Drain

CONFIGURATIONS	PAN CODE	COLANDER DEPTH	FITS H-PAN DEPTH*
GN 1/1 32,5 x 53 cm	13CLRHP	7,6 cm	10 cm
	15CLRHP	12,7	15
GN 1/2 26,5 x 32,5 cm	23CLRHP	7,6	10
	25CLRHP	12,7	15
GN 1/3 17,6 x 32,5 cm	33CLRHP	7,6	10
	35CLRHP	12,7	15
GN 1/6 16,2 x 17,6 cm	63CLRHP	7,6	10
	65CLRHP	12,7	15

Case Pack for all Pans: 6. Lids listed on following page.
* Fits this pan depth & deeper.



H-Pan with Handles

- Full size 6,5 cm deep food pan with handles fits all leading manufacturers' hot holding bins.
- Two handles allow employees to reach the pan from either side of the unit for safe handling.
- Flat Cover, Cover with Handle and Notched Cover with Handle fit on pan.

CONFIGURATIONS	PAN CODE	PAN DEPTH	APPROXIMATE CAPACITY
GN 1/1 32,5 x 53 cm	12HPH*	6,5 cm	8,42 L

Case Pack: 6 Lids listed on following page.



12HPH

GASTRONORM HIGH HEAT H-PAN™ LID SIZES & ORDERING INFORMATION

Flat Cover

Available in all pan sizes.



FITS PANS	LID CODE	DESCRIPTION
GN 1/1 32,5 x 53 cm	10HPC	Flat cover
	10HPCH	Cover with handle
	10HPCHN	Notched cover w/handle
	10CWGL	GripLid

GN 1/2 Long 16,2 x 53 cm	20LPHPC	Flat cover
-----------------------------	---------	------------

Cover with Handle

Deep molded handle gives secure grip.

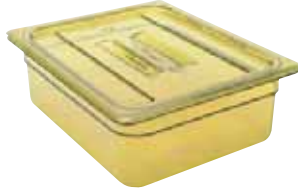

GN 1/2 26,5 x 32,5 cm	20HPC	Flat cover
	20HPCH	Cover with handle
	20HPCHN	Notched cover w/handle
	20CWGL	GripLid
	20HPL	FlipLid
	20HPLN	Notched FlipLid

Notched Cover with Handle

Easy access for ladles or spoons.

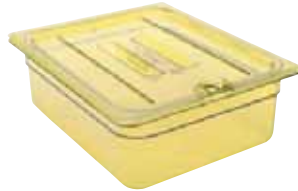

GN 1/3 17,6 x 32,5 cm	30HPC	Flat cover
	30HPCH	Cover with handle
	30HPCHN	Notched cover w/handle
	30CWGL	GripLid
	30HPL	FlipLid
	30HPLN	Notched FlipLid

FlipLid®

Flip up lid to easily access contents. Food can be held without getting dried out, increasing yields.



GN 1/4 16,2 x 26,5 cm	40HPC	Flat cover
	40HPCH	Cover with handle
	40HPCHN	Notched cover w/handle

GN 1/6 16,2 x 17,6 cm	60HPC	Flat cover
	60HPCH	Cover with handle
	60HPCHN	Notched cover w/handle
	60CWGL	GripLid
	60HPL	FlipLid
	60HPLN	Notched FlipLid

Notched FlipLid®

Flip Lid with notch to rest spoon in contents with lid closed.



GN 1/8 16,12 x 13,17 cm	80HPC	New! Flat cover
	80HPCH	New! Cover with handle
	80CHPCHN	New! Notched cover w/handle

GN 1/9 10,8 x 17,6 cm	90HPC	Flat cover
--------------------------	-------	------------

Case pack for all lids: 6

GripLid®

Molded-in polyurethane gasket on the lid grips the side of the food pan, reducing spills and points of cross-contamination.

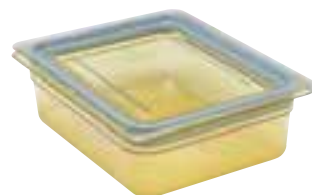

Color: Amber (150).
GripLid Color: Clear (135).
Amber color may vary.

FlipLids are covered by U.S. Patent D 420,849, D 422,838, D 427,012 & D 6,273,288 B1.

Personalization available on non-food contact areas only. See cresting section for information and ordering.



TRANSLUCENT POLYPROPYLENE GASTRONORM FOOD PANS

- An economical choice for storing food.
- Translucent polypropylene material provides content visibility and high chemical resistance.
- Withstands temperature ranges from -40° to 70°C.
- Meets Gastronorm GN food pan specifications.
- Non-stick smooth interior surfaces promotes easy cleaning.

Color: Translucent (190).
 Graduation marks and capacities are approximate.
 Full Size (GN 1/1) Translucent Food Pans are not designed for use in front loading carriers UPC400, UPCS400,UPCH4002, UPC600, UPC800, UPCH8002, UPC1200, UPC1600, UPCH1600. Camtherm® Carts or Combo Carts.
 Translucent Food Pans are made of FDA approved materials.
 Translucent Food Pans interstack with other Cambro Food Pans.
 Personalization available on non-food contact areas only. See crestring section for information, ordering and pricing.
 Translucent Pans are not designed for steam table use.



Ideal for transporting in Cambro top loading carriers.

UPC100	UPCS140	100MPC
UPC140	UPCS160	240MPC
UPC160		



Use Cambro StoreSafe® Food Rotation Labels on Translucent Food Pans to manage inventory and reduce waste.



GN 1/2

GN 1/4

GN 1/6

GN 1/1

GN 1/3

TRANSLUCENT POLYPROPYLENE GASTRONORM FOOD PANS AND LIDS SIZES

Color: Translucent (190).

All Translucent Gastronorm Food Pans are made of FDA approved materials.

All polypropylene GN Food Pans are designed to CEN Gastronorm Standard EN 631-1.

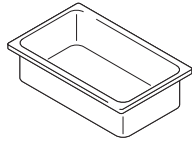

CONFIGURATIONS	PAN CODE	PAN DEPTH	APPROXIMATE CAPACITY
GN 1/1 32,5 x 53 cm	14PP	10 cm	13 L
	16PP	15	19,5
	10PPD	—	Drain shelf

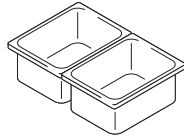

GN 1/2 26,5 x 32,5 cm	24PP	10	5,9
	26PP	15	8,9
	20PPD	—	Drain shelf

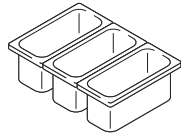

GN 1/3 17,6 x 32,5 cm	32PP New!	6,5	2,4
	34PP	10	3,6
	36PP	15	5,3
	30PPD	—	Drain shelf

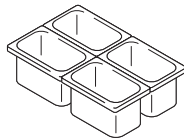

GN 1/4 16,2 x 26,5 cm	42PP New!	6,5	1,7
	44PP	10	2,5
	46PP	15	3,7
	40PPD	—	Drain shelf

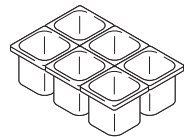

GN 1/6 16,2 x 17,6 cm	62PP New!	6,5	1
	64PP	10	1,5
	66PP	15	2,2
	60PPD	—	Drain shelf

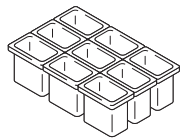

GN 1/9 10,8 x 17,6 cm	92PP New!	6,5	0,57
	94PP	10	0,85
	90PPD	—	Drain shelf

Case Pack: 6



1/1



1/3



1/4



1/6

FITS PANS	LID CODE	DESCRIPTION
GN 1/1 32,5 x 53 cm	10PPCH	Cover w/ handle
	10PPCWSC New!	Seal cover
GN 1/2 26,5 x 32,5 cm	20PPCH	Cover w/ handle
	20PPCWSC New!	Seal cover
GN 1/3 17,6 x 32,5 cm	30PPCH	Cover w/ handle
	30PPCHN	Notched cover w/ handle
	30PPCWSC New!	Seal cover
GN 1/4 16,2 x 26,5 cm	40PPCH	Cover w/ handle
	40PPCWSC New!	Seal cover
GN 1/6 16,2 x 17,6 cm	60PPCH	Cover w/ handle
	60PPCHN	Notched cover w/ handle
	60PPCWSC New!	Seal cover
GN 1/9 10,8 x 17,6 cm	90PPC	Flat cover
	90PPCWSC New!	Seal cover

Case Pack for all Lids: 6



Drain Shelf

Available for all food pan sizes.



Cover with Handle

Available for all food pan sizes. Except for GN 1/9 size.



Notched Cover with Handle

Available for GN 1/3 and GN 1/6 food pans.



New!

Seal Cover

Translucent seal covers protect food quality while eliminating the expense of plastic wrap. Available for all pan sizes.



Flat Cover

Only available for GN 1/9 food pans.

COLDFEST® GASTRONORM FOOD PANS, CROCKS, COVERS & PUMPS



- Keeps contents chilled at or below HACCP guidelines of 4°C without the use of messy ice.
- Freeze upside down for eight hours or overnight before filling with pre-chilled product.
- Half and third-size pans hold contents cold for up to eight hours. Sixth size pans and crocks hold contents cold for up to six hours.
- Conforms to Gastronorm exterior dimensions to fit standard food bars or make tables.
- Stackable to save space when freezing and storing.
- Can be used for direct food contact with all types of food products.

Colors: Black (110), White (148).

Flat Cover Color: Clear (135).

Seal Cover Color: White (148).

Pump with Cover Color: Clear (135).

Suggested holding times are based on tests with ambient room conditions of up to 23°C.

ColdFest is covered under U.S. Patent D 419,364.

* Pumps and round covers not NSF listed.

All ColdFest GN Food Pans are designed to CEN Gastronorm Standard EN 631-1.



Ideal in Cambro Salad bars or to chill condiments and creamers.

Pans / Crock



CODE	26CF	36CF	66CF	CFR18
CONFIGURATIONS	GN 1/2 – 26,5 x 32,5 cm	GN 1/3 – 17,6 x 32,5 cm	GN 1/6 – 16,2 x 17,6 cm	∅ 17,3 cm
DEPTH	15 cm	15 cm	15 cm	17 cm
APPROX. CAPACITY	6 L	3,5 L	1,4 L	1,6 L

Case Pack: 1



ColdFest Food Pans are made with high-impact resistant ABS shells and non-toxic refrigerant gel cores.

Covers

CODE	20CFC	30CFC	60CFC	CFRC18*	CFRSC18
DESCRIPTION	Flat cover	Flat cover	Flat cover	Flat cover	Seal cover
FITS COLDFEST	GN 1/2	GN 1/3	GN 1/6	Crock	Crock

Case Pack: 2

Pumps with Covers



CODE	CFPSRC10*	CFPMRC10*	CFPFR10*
DESCRIPTION	Standard pump dispense 29,5 mL portions	Maxi pump for chunky condiments	Fixed nozzle pump for controlled dispensing
DIMENSIONS W x D x H	18,4 x 22,8 x 28,5 cm	18,4 x 26 x 31,4 cm	18,4 x 29,5 x 29,8 cm

Case Pack: 1



STORESAFE® FOOD ROTATION LABELS

- Label and adhesive dissolve in less than 30 seconds.
- Run under hot or cold water or through the dishwasher.
- Safe for all sewer and septic systems and will not build up in drains.
- Withstands freezing temperatures as low as -40°C.
- Withstands high heat temperatures up to 93°C for 4 hours.
- Microwave safe.
- Leaves behind no sticky residue which can be a breeding ground for bacteria.
- Assists in a proper First In First Out (FIFO) food storage system.
- 100% dissolvable and biodegradable.

Label color: White (148).

 * Available for ordering in cases only.
 No broken cartons.

 100% biodegradable. FDA approved material.



Eliminates sticky residue and prevents cross contamination! No more scraping!



Dissolves completely off all containers when placed through dishwasher or under running water.



Retail Blister Pack



CASE CODE	23SL
LABEL SIZE	5 x 7,6 cm
CASE PACK	20 rolls, 100 labels per roll

StoreSafe Label Blister Pack is covered by U.S. Patent 690,589 S.

Bulk Dispenser Pack – Half Size Labels

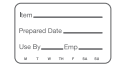

CASE CODE	1252SLB250	1252SLINB250
LABEL SIZE	3 x 5 cm	3 x 5 cm
CASE PACK	24 rolls, 250 labels per roll	24 rolls, 250 labels per roll

Bulk Dispenser Pack

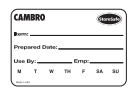
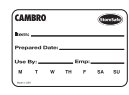

CASE CODE	23SLB250	23SLB6250
LABEL SIZE	5 x 7,6 cm	5 x 7,6 cm
CASE PACK	24 rolls, 250 labels per roll	6 rolls, 250 labels per roll

Bulk Dispenser Pack – Blank Labels



CASE CODE	23SLINB250
LABEL SIZE	5 x 7,6 cm
CASE PACK	24 rolls, 250 labels per roll

Laser Sheet



BOX CODE	SLL30 (Avery® 5160)
LABEL SIZE	2,54 x 6,35 cm
CASE PACK	100 sheets, 30 labels per sheet 21,6 x 27,9 cm sheet size



PIZZA DOUGH BOXES



DB18263P

Polypropylene

- Ideal for storing, transporting, proofing and cooling dough.
- Lightweight, durable, and break resistant.
- Chemical resistant won't absorb odors and is easy to clean.
- Boxes nest tightly together to keep out dirt and contaminants, extending product freshness.

- The previous box acts as a tight lid for the box below, reducing the need and expense of covers.
- Withstands temperatures from -40° to 70°C.
- Cover can be used as an 46 x 66 cm tray.

Color: White (148).

Polycarbonate & Polypropylene dough boxes do not inter stack

CD1826PDB Color: Coffee Beige (157), Brown(131), Black (110), Slate Blue (401), Grey (180).

* Polypropylene dough boxes are safe for use in high temperature dishwashers.

Caster Type A: 12,7 cm Casters: 2 fixed, 2 swivel, 1 with brake.



CD1826PDB

Capacity: 136 kg
Caster Type: A
Holds: DB18263CW, DB18266CW, DB18263P



Polycarbonate

- Prevents crusting to increase the storage life of dough.
- Virtually unbreakable polycarbonate construction is reinforced on all sides.
- Boxes won't bend or lose their shape.

- Withstands temperatures from -40° to 99°C.
- Available in 7,62 and 15,24 cm depths.



DB18266CW

DB18263CW

CODE	OUTSIDE DIMENSIONS	INSIDE DIMENSIONS
Polypropylene Pizza Dough Box		
DB18263P	46 x 66 x 7,6 cm	40,6 x 60,9 cm
Polypropylene Cover		
DBC1826P	46 x 66	—
Polycarbonate Pizza Dough Boxes		
DB18263CW	46 x 66 x 7,6	40,6 x 60,9
DB18266CW	46 x 66 x 15,3	40,6 x 60,9
Polycarbonate Cover		
DBC1826CW	46 x 66	—

Case Pack: 6 **Color:** White (148).

Camdolly® For Pizza Dough Boxes

CD1826PDB** 50,5 x 71 x 26 44,5 x 64,5

Case Pack: 1 ** Optional Strap Available. See Camdolly section for available colors.

INGREDIENT BINS & CAMCRISPER®

Ingredient Bins

- Store bulk dry ingredients such as flour and grain.
- Hygienic clear sliding lid reduces handling and allows for quick content identification.
- Bin made of FDA-accepted material so no liners are needed.
- Designed to fit under standard work tables.

Camcrisper

- A self-contained system for brining or storing, washing and transporting bulk produce.
- Prevents cross contamination and minimizes unnecessary handling.
- Transfer dry produce out of cartons into bin, cover and roll into cooler for safe storage.
- Wash and rinse produce for easy and safe prep.

7,6 cm Casters: 2 fixed, 2 swivel.

Color: White (148).

Scoops sold separately. S-Hook included.



Casters feature wide wheels for excellent stability and weight bearing capability.



CODE	IBS20	IBS27	IBS37	IBSF27
DIMENSIONS W x L x H	33 x 75 x 71 cm	42 x 75 x 71 cm	55 x 75 x 71 cm	33 x 76,5 x 72,5 cm
CAPACITY	81 L	102 L	140 L	102 L
CUBIC METER	0,081	0,102	0,140	0,101
LOAD CAPACITY (SUGAR)	77 kg	103 kg	143 kg	98 kg
LOAD CAPACITY (FLOUR)	63 kg	68 kg	102 kg	68 kg

Case Pack: 1



CODE	IB32	IB36	IB44	CC32 (CAMCRISPER)
DIMENSIONS W x L x H	56 x 61 x 58,5 cm	39 x 75 x 74 cm	47 x 75 x 74 cm	56 x 61 x 58,5
CAPACITY	121 L	129 L	161 L	121 L
CUBIC METER	0,123	0,134	0,160	0,123
LOAD CAPACITY (SUGAR)	98 kg	114 kg	145 kg	24 lettuce heads (unfinished)
LOAD CAPACITY (FLOUR)	73 kg	82 kg	104 kg	42 lettuce heads (finished)

Case Pack: 1

POLYCARBONATE SCOOPS & MEASURING CUPS

Polycarbonate Scoops

- Virtually unbreakable polycarbonate will not dent, chip or rust.
- Molded-in sure grip handle includes a hole for hanging.
- Ideal for use with Cambro Ice Caddies and Ingredient Bins.

Color: Clear (135).

Personalization not available.



CODE	APPROXIMATE CAPACITY	CASE PACK
SCP6CW	170 g	12
SCP12CW	340	12
SCP24CW	680	12
SCP64CW	1814	6

Polycarbonate Measuring Cups

- Externally marked graduations are molded in and imprinted in red for American standard and blue for metric for easy measurement.
- Durable, virtually unbreakable polycarbonate will not dent, ensuring an accurate measurement every time.
- Molded-in handle will not break off.

Color: Clear (135).

Personalization available on non-food contact areas only. See cresting section for information and ordering.

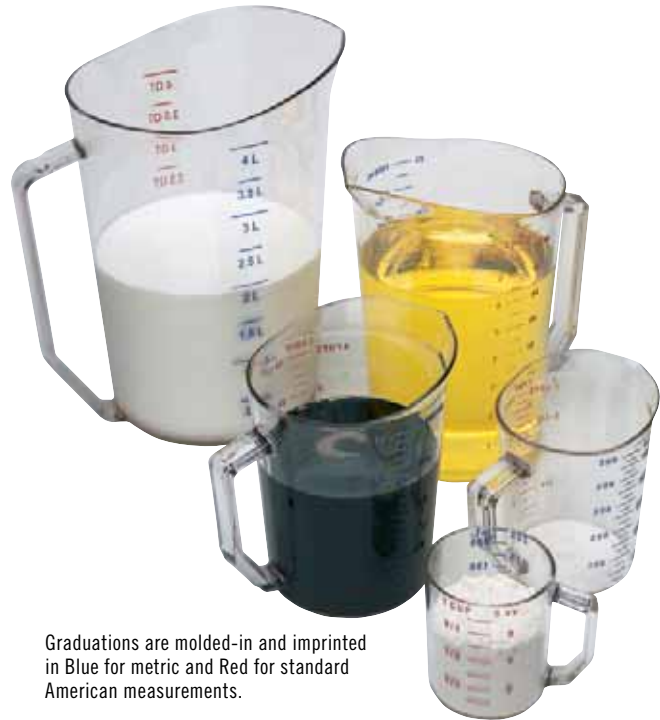

CODE	CAPACITY	CASE PACK
25MCCW	225 mL (dry measure)	12
50MCCW	0,5 L	12
100MCCW	1	12
200MCCW	2	12
400MCCW	4	1

Graduations are molded-in and imprinted in Blue for metric and Red for standard American measurements.



TABLE SERVICE

Polycarbonate Dinnerware

Versa Camcovers®

Polycarbonate Camcovers

Promote Your Brand

Polycarbonate Pitchers

Aliso® Barware, Goblets and Dessert Glass

Cambro® Tumblers and Disposable CamLids®

CamView® Camliters

Beverage Dispenser, Pail with Bail & Swirl Bowls®

**Polycarbonate Wine Buckets,
Punch Bowls & Bud Vase**



POLYCARBONATE DINNERWARE

5 5 YEAR PRORATED
GUARANTEE AGAINST
BREAKAGE

- Virtually unbreakable
Polycarbonate resists stains, odors and scratches.
- Textured surface on salad and dinner plates for long wear.
- Ideal for schools, cafeterias, day care centers and healthcare facilities.
- Mug and stacking cup can be personalized.



Oval Platters & Compartment Plates



CODE	90SPCW	120CWP	93CW	HK93BCW
DIAMETER	22,9 x H 4 cm	30,5 x 22,9 cm	22,9 cm	24,1 cm
DESCRIPTION	Round, soup bowl	Oval, narrow rim	Narrow rim	Narrow rim
CASE PACK	48	24	48	12

* HK93BCW is available in Beige (133) only. Not recommended for microwave use.

Plates



CODE	10CWNR	9CWNR	825CWNR	725CWNR	65CWNR	55CWNR
DIAMETER	25,4 cm	22,9 cm	21 cm	18,4 cm	16,5 cm	14 cm
DESCRIPTION	Narrow rim	Narrow rim	Narrow rim	Narrow rim	Narrow rim	Narrow rim
CASE PACK	48	48	48	48	48	48

Not recommended for microwave use.

Bowls



Optional lid available

CODE	10CW	10CWL	35CW	45CW	50CW	60CW	100CW	150CW
APPROX. CAPACITY	278 mL	—	252 mL	150 mL	452 mL	322 mL	370 mL	494 mL
DESCRIPTION	Square bowl	Lid for 10CW bowl	Bouillon	Fruit cup	Nappie bowl	Grapefruit bowl	Nappie bowl	Square bowl
CASE PACK	48	48	48	48	48	48	48	48
SHAPE	Square	Square	Round	Round	Round	Round	Round	Top/round bottom/square
OUTSIDE DIAMETER	10,2 x 10,2 cm	—	9,8 cm	11,7 cm	13,3 cm	15,2 cm	12,5 cm	Top: 13,3 cm Bottom: 6,4 x 6,4 cm
HEIGHT	4,8 cm	—	5,4 cm	3,3 cm	5,4 cm	4 cm	24,3 cm	5,7 cm

Not recommended for microwave use.

Mug & Cup



CODE	75CW	96CW
APPROX. CAPACITY	239 mL	288 mL
DESCRIPTION	Stacking cup	Mug
CASE PACK	48	48
MAX DIA./HEIGHT	10,3* cm / 8 cm	10,6* cm / 9,5 cm
FULL SIZE CAMRACK®	16C414	16C414

* Maximum diameter includes handles.
Not recommended for microwave use.

Heat Keepers



CODE	HK93CW	HK39	HK93PMC
DESCRIPTION	3 compartment base and cover	Heat keeper base and cover for 22,9 cm plate	Camcarrier® for HK93cw available by special request. Call Cambro Customer Service for more information.
CASE PACK	6	6	

HK93CW is available in Beige (133).
HK39 is available in Antique White (148).
Not recommended for microwave use.

VERSA CAMCOVERS®

Serve hot food hot with the Versa Camcover, an elegant and efficient alternative to traditional metal covers.

- Withstands temperatures up to 149°C.
- Covers remain cool to the touch for easy handling.
- Lighter and quieter than metal covers.
- Elegant appearance without polishing.

- Keeps food warm longer than metal covers.
- Available in a variety of sizes in round and square.

Colors: Ivory (380), Granite Gray (191), Antique Parchment (101).

For help selecting the correct size plate cover, refer to the Camcover Sizing Guide on our website at www.cambro.com. Or, send one of your plates to Cambro Customer Service for sizing.

Made of fiberglass material, microwave safe.



CODE	INSIDE DIAMETER	OUTSIDE HEIGHT	CASE PACK
Square			
85SFVS	20,91 cm	7 cm	12
978SFVS	25,4	7	12
Round			
68VS	16,5	5,6	12
86VS	21	6,7	12
91VS	23,2	6,8	12
913VS	24,9	6,8	12
95VS	23,7	6,8	12
99VS	24,3	6,7	12
911VS	24,6	7	12
100VS	25,4	6,8	12
103VS	25,9	6,8	12
105VS	26,2	6,8	12
106VS	26,4	7,2	12
1010VS	27	6,8	12
1012VS	27,3	6,8	12
1014VS	27,6	6,8	12
116VS	28,9	8,1	12
120VS	30,5	7,3	12
124VS	31,1	7,3	12

POLYCARBONATE CAMCOVERS®

- Food stays hot and appetizing without re-heating.
- Ideal for use in heated carts up to 99°C.*
- Virtually unbreakable polycarbonate will not dent or scratch.
- Lightweight for quiet service.
- Saves on labor with no polishing required.

Colors: Clear (135), Amber (153), Beige (133), Silver (486).

For help selecting the correct size plate cover, refer to the Camcover Sizing Guide on our website at www.cambro.com. Or, send one of your plates to Cambro Customer Service for sizing.

* Not recommended for microwave use.



CODE	INSIDE DIAMETER	OUTSIDE HEIGHT	CASE PACK
806CW	21,4 cm	6,8 cm	12
900CW	23,2	7	12
901CW	23,7	7,2	12
905CW	24,1	7,2	12
909CW	24,8	7	12
9011CW	25,4	7,3	12
9013CW	25,4	7	12
1000CW	25,9	6,8	12
1005CW	26,8	7,2	12
1007CW	27	7	12
1013CW	27,5	6,8	12
1101CW	27,9	6,8	12
1202CW	30,8	7	12

PROMOTE YOUR BRAND

Personalize tumblers, barware, pitchers or other table service items with your logo or design. Use personalized drinkware in promotions.

Food storage products can also be personalized to identify menu items, add fill lines for recipes or to add instructions in multiple languages to help ensure product quality and consistency.



Look for this icon that identifies items that can be personalized.

IMPRINTING TABLE SERVICE AND STORAGE ITEMS

Sample Turnaround Time:

7-10 business days after receipt of approved artwork

Print Area: 6 mm to 10 cm, subject to printable area on each item

Full Case Quantity: No broken cartons

PERSONALIZATION CHARGES (NET)

Sample Charge: *** (Charge will be billed on sample order, credited on first purchase order)

Plate Charge: *** (Billed on sample order, one time charge)

Set-Up Charge: *** (Per order)

Cost Per Imprint: *** per side

HOW TO ORDER A SAMPLE

1. Request a Sample

Contact your local Cambro representative to complete and submit your sample request to Cambro.

2. Provide Artwork

Provide ready to use artwork, digital format only. Completed sample request form must be submitted to Cambro **PRIOR** to artwork being sent. If artwork is incomplete, graphic support services are available at *** per hour.

3. Submit Artwork

E-mail artwork to your Cambro Rep or direct to Cambro at letsgetpersonal@Cambro.com. Title e-mail subject with logo name and provide contact info.

File dimensions: 100% reproduction size, 300dpi resolution.

File type:

Adobe® Illustrator®, Photoshop®.

File format: jpeg, tiff, and eps.

Or mail digital artwork to: Cambro Manufacturing Company. Attn: Kristie Patterson, 7601 Clay Avenue, Huntington Beach, CA 92648.

4. Questions regarding artwork?

Tel: (49)7022-90-100-0;
Ireland Tel: 1800 509 046;
for UK Tel: 0800 587 0057 or
Fax: (49)7022-90-100-19.

5. Sample Approval

A signed sample approval form must be faxed to Cambro customer service prior to processing any purchase orders. This form is included with each sample.

*** Contact your Cambro representative for pricing.



CHOOSE ANY ONE OF THESE STANDARD IMPRINT COLORS

Due to the catalog printing process, the colors shown may not be exact.



Red



Yellow



Light Blue



Dark Blue



Green



Orange



Violet



Black



White



Grey



Gold



Silver

POLYCARBONATE PITCHERS

- Made of virtually unbreakable Polycarbonate.
- Lightweight for easy handling.
- Exclusive ice-control contoured lip and pour spout reduce spills.
- Slotted base allows for complete and sanitary drying.

Color: Clear (135). P600CW is also available in Amber (153).

Capacities calculated to rim.

Personalization available. See cresting section for information, ordering and pricing.

PC34CW Stackable Pitcher is covered by the following U.S. Patent D 682,002 S.



P600CW, P480CW and P320CW
An industry standard. Broad base for stability, prevents tipping.

PL60CW
Laguna® pitcher with hammered texture that hides scratches. Pour liquids from front or ice and liquid from sides. Matching tumblers available.



CODE	P320CW	P480CW	P600CW	P60CW	PL60CW
CAPACITY	0,95 L	1,4 L	1,8 L	1,8 L	1,8 L
HEIGHT WITH SPOUT	17 cm	20 cm	20,5 cm	23 cm	20 cm
DIAMETER WITH HANDLE	14,5 cm	16 cm	17 cm	18,5 cm	17 cm

Case Pack: 6

PE600CW
Economy and lightweight design. Pour liquids from front or ice and liquid from sides.

P64CW
Tapered design and drip-proof spout.

PC64CW
Three position lid can strain ice, free pour or close to protect contents.

PC34CW
Stackable pitchers and lid with frosted design to hide scratches.

P34CW
Stackable Pitcher only.
P34LCW
Stackable Pitcher Lid only.



CODE	PE600CW	P64CW	PC64CW	PC34CW	P34CW	P34LCW
CAPACITY	1,8 L	1,9 L	1,9 L	1 L	1 L	—
HEIGHT WITH SPOUT	20 cm	23,5 cm	24,8 cm with lid	19,05 cm with lid	16,8 cm	5,11 cm
DIAMETER WITH HANDLE	18,7 cm	18,5 cm	18,5 cm	17 cm	17 cm	11,4 cm

Case Pack: 6

POLYCARBONATE ALISO® BARWARE, GOBLETS AND DESSERT GLASS

Aliso Barware replicates the look, heft and clarity of glass with shatterproof polycarbonate. The smooth seamless appearance makes Aliso Barware a stylish choice for casual dining, outdoor events or for poolside service.

- Barware items have large, heavy bases for stability.
- Bases designed for fast draining and complete drying.
- Chill or frost barware without concerns of thermal shock damage.

Color: Clear (135).

Capacities calculated to rim.

Personalization available. See cresting section for information, ordering and pricing.



CODE	BWM10CW	BWW10CW	BWP14CW	BWB16CW	GB850CW	GB1200CW	DG3CW*
DESCRIPTION	Martini	Wine	Pilsner	Beer mug	Goblet	Goblet	Dessert glass
MAX DIAMETER	12,2 cm	7,5 cm	8,3 cm	12,1 cm	7 cm	7 cm	5,8 cm
MAX HEIGHT	17,5 cm	17,1 cm	24,3 cm	15,9 cm	15,9 cm	19,4 cm	7,7 cm
FULL SIZE CAMRACK®	9S638	25S638	25S958	16S638	36S534	36S738	49S318
CAPACITY TO RIM	310,5 mL	310,5 mL	458,4 mL	473 mL	266 mL	378 mL	100 mL
CASE PACK	12	24	24	12	24	24	72

* Available for ordering in cases only. No broken cartons.

CAMBRO® TUMBLERS AND DISPOSABLE CAMLIDS®



- Disposable lids fit tightly on Cambro tumblers, avoiding spills.
- Lids have tumbler code imprinted on them for easy cross reference.
- Includes a cross slot for straws.
- Reusable tumblers provide a “green” solution to reduce the waste of using disposable cups for kids’ drinks.
- Reusable tumblers save operators the cost of replacing broken glass or disposable kids’ cups.
- Reusable tumblers can be personalized with logos or exclusive designs.
- Doubles as an employee drink cup that requires a lid.

Disposable CamLid Color:
Translucent (190).

.....
Disposable lids are sold in full cases only.
No broken cartons.
.....

POLYCARBONATE Virtually Unbreakable



TUMBLER	LID
800CW	CLNT8, CLST6
950CW	CLNT10, CL950P
1200CW	CLLT10
1600CW	CL900P

COLORWARE Value Tumbler



TUMBLER	LID
500P/500P2	CLJ6
800P	CLNT8, CLST6
900P/900P2	CL900P
950P/950P2	CL950P
1200P	CLLT10
1600P	CL900P

DEL MAR® Crackled Glass Look



TUMBLER	LID
D8	CLNT8, CLST6
D12	CLLT10
D14	CLST9, CLAM8B5
D16	CLLT12
D24	CLAM8B5

LIDO® Diamond Point Design



TUMBLER	LID
LDT5	CLJ6
LDT6	CLST6
LDT9	CL900P
LDT10	CLNT10
LDT12	CLNT12
LDT16	CLST9
LDT22	CLSM8B5

HUNTINGTON® Elegant Design, Virtually Unbreakable



TUMBLER	LID
HT8CW	CLNT8
HT10CW	CLNT10, CL950P
HT12CW	CLLT10
HT120CW	CLNT12
HT14CW	CLST9
HT16CW	CLST9, CLAM8B5
HT22CW	CLSM8B5

LAGUNA® Hammered Texture



TUMBLER	LID
LT6	CLLT6
LT8	CLLT8
LT12	CLLT12
LT14	CLST9
LT16	CLST9, CLAM8B5

NEWPORT Fluted Design



TUMBLER	LID
NT5	CLNT5
NT8	CLNT8
NT9	CL900P
NT10	CLNT10
NT12	CLNT12
NT14	CLLT12
NT16	CL900P
NT20	CLSM8B5

LIDO® TUMBLERS

- Ideal for fast-paced casual dining or outdoor events. Offers the look of glass without the risk.
- Easy to clean internal stacking ring promotes stable and space-efficient storage.
- Prevent spills with tight fitting disposable Camlids®.
- Made of impact resistant SAN plastic that resists chips and breaks, minimizing replacement costs.

Color: Clear (152).

Capacity is to the top fill-line.

* 177 and 266 mL tumblers feature subtle graduation markings intended for use in healthcare operations.

Lido Tumblers are covered by U.S. Patent D720,963 S.



CODE	LDT5	LDT6	LDT9	LDT10	LDT12	LDT16	LDT22
FITS LID	CLJ6	CLST6	CL900P	CLNT10	CLNT12	CLST9	CLSM8B5
DIAMETER	5,9 cm	6,8 cm	8,1 cm	7,3 cm	7,6 cm	8,4 cm	8,9 cm
HEIGHT	9,4 cm	9,4 cm	9,4 cm	11,4 cm	12,5 cm	13,5 cm	16,8 cm
FULL SIZE CAMRACK®	49S318	36S318	25S318	36S418	30S434	25S534	20S638
CAPACITY TO RIM	150 mL	177 mL*	266 mL*	300 mL	355 mL	480 mL	650 mL

Case Pack: 36

POLYCARBONATE HUNTINGTON® & SAN NEWPORT TUMBLERS

Huntington Tumblers

- Feature the elegant look and feel of glass without the high replacement costs.
- Made of virtually unbreakable polycarbonate
- Lightweight.
- Stacking lugs to prevent sticking
- Three sided drain bottom for easy washing and drying.

Colors: Azure Blue (196), Clear (135).

Capacities calculated to rim.

Personalization available. See creasing section for information and ordering.

Withstands temperatures from -40° to 99°C.



CODE	HT5CW	HT8CW	HT10CW	HT120CW	HT12CW	HT14CW	HT16CW	HT22CW
MAX DIAMETER	6 cm	6,8 cm	7,1 cm	7,6 cm	8,6 cm	8,3 cm	8,4 cm	8,9 cm
MAX HEIGHT	9 cm	11,3 cm	12,2 cm	12,8 cm	9,5 cm	12,4 cm	14 cm	17 cm
FULL SIZE CAMRACK®	49S318	36S418	36S434	25S434	25S418	25S434	25S534	25S638
CAPACITY TO RIM	148 mL	237 mL	296 mL	355 mL	355 mL	414 mL	473 mL	652 mL
CASE PACK	36	36	36	36	36	36	36	36

Newport Tumblers

- Fluted design features the upscale look of glass with the safety benefits and cost savings of plastic.
- Impact resistant SAN plastic resists chips and breaks.
- Stacking lugs prevent sticking.
- Sani-Rim lip provides a sanitary drinking surface.

Colors: Clear (152), Amber (153), Slate Blue (401).

Capacities calculated to rim.

Personalization available. See creasing section for information and ordering.

Withstands temperatures from -20° to 85°C.



CODE	NT5	NT8	NT9	NT10	NT12	NT14	NT16	NT20
MAX DIAMETER	6,4 cm	6,8 cm	8,3 cm	7,1 cm	7,6 cm	7,9 cm	8,3 cm	8,7 cm
MAX HEIGHT	9,4 cm	10,2 cm	8,4 cm	11,6 cm	13 cm	12,7 cm	14,6 cm	16,5 cm
FULL SIZE CAMRACK	36S318	36S418	25S318	36S434	25S434	25S434	25S534	25S638
CAPACITY TO RIM	189 mL	228 mL	275 mL	300 mL	373 mL	414 mL	485 mL	650 mL
CASE PACK	36	36	36	36	36	36	36	36

SAN LAGUNA® & DEL MAR® TUMBLERS

Laguna Tumblers

- Hammered texture hides water spots and scratches.
- Made of impact resistant SAN.
- Lightweight and easy to carry.

Colors: Clear (152), Spanish Green (427).

Capacities calculated to rim.

Personalization available. See cresting section for information, ordering and pricing.

Withstands temperatures from -20° to 85°C.



CODE	LT6	LT8	LT10	LT12	LT14	LT16	LT22
MAX DIAMETER	6,3 cm	6,9 cm	7,4 cm	7,9 cm	8,3 cm	8,4 cm	9,3 cm
MAX HEIGHT	10,7 cm	10,9 cm	12,1 cm	12,7 cm	13,1 cm	14 cm	15,4 cm
FULL SIZE CAMRACK®	36S418	36S418	36S434	25S434	25S434	25S534	16S534
CAPACITY TO RIM	177,4 mL	236,6 mL	295,7 mL	354,9 mL	414 mL	473,2 mL	650,6 mL
CASE PACK	36	36	36	36	36	36	36

Del Mar Tumblers

- Crackled glass look features the lightweight handling of plastic.
- Thick sturdy base and rolled rim edge for added stability.
- Made of impact resistant SAN plastic.

Colors: Clear (152), Ruby Red (156), Sapphire Blue (608), Light Amber (609).

Capacities calculated to rim.

Personalization available. See cresting section for information, ordering and pricing.

Del Mar Tumblers are covered by the following U.S. Patent D 478,778 S.

Withstands temperatures from -20° to 85°C.



CODE	D8	D12	D14	D16	D24
MAX DIAMETER	6,7 cm	7,5 cm	8,3 cm	7,8 cm	8,7 cm
MAX HEIGHT	10,6 cm	12 cm	8,3 cm	15,1 cm	16,8 cm
FULL SIZE CAMRACK	36S418	25S434	25S318	25S534	25S638
CAPACITY TO RIM	237 mL	355 mL	414 mL	473 mL	710 mL
CASE PACK	36	36	36	36	36

SAN Colorware Tumblers & Coca-Cola® Tumblers

- A classic value tumbler ideal for casual dining.
- Textured on the outside to resist scratching.
- Made of impact resistant SAN
- Interior stacking lugs for easy storing.
- Sani-Rim lip provides a sanitary drinking surface.

Colors: Slate Blue (401), Clear (152), Amber (153), Ruby Red (156).

Capacities calculated to rim.

Personalization available. See creasing section for information and ordering.

Withstands temperatures from -20° to 85°C.



CODE (72 PACK)	500P	800P	900P	950P	1200P	1600P	2000P	—
CODE (24 PACK)	500P2	800P2	900P2	950P2	1200P2	1600P2	2000P2	3200P2
MAX DIAMETER	5,7 cm	6,7 cm	8,1 cm	7 cm	7,5 cm	8 cm	8,6 cm	10 cm
MAX HEIGHT	9,2 cm	10,2 cm	8,25 cm	11,1 cm	13,2 cm	14,6 cm	16,5 cm	18,4 cm
FULL SIZE CAMRACK®	49S318	36S418	25S318	36S418	25S434	25S534	25S638	16S738
CAPACITY TO RIM	154 mL	231 mL	287 mL	290 mL	373 mL	485 mL	650 mL	976 mL
P CODE-CASE PACK	72	72	72	72	72	72	72	—
P2 CODE-CASE PACK	24	24	24	24	24	24	24	24

Coca-Cola® Tumblers

- Colorware Tumblers featuring the Coca-Cola trademark logo in White.
- Available only to Coca-Cola fountain customers for foodservice use.

Colors: Clear (152).

Coca-Cola Logo is imprinted in white only.

These trademarked vessels may not be resold at retail and are available only for distribution to Coca-Cola Fountain customers for foodservice use.

Withstands temperatures from -20° to 85°C.



CODE	20CC	32CC
MAX DIAMETER	8,6 cm	10 cm
MAX HEIGHT	6,4 cm	7,3 cm
FULL SIZE CAMRACK	25S638	16S738
CAPACITY TO RIM	650 mL	976 mL
CASE PACK	72	24

Polycarbonate Tumblers and CamView® Camliters®

Polycarbonate Tumblers

- The look and feel of glass but made of virtually unbreakable polycarbonate.
- Textured exterior surface resists scratching.
- Smooth interior promotes easy cleaning.
- Designed with a Sani-Rim lip for sanitary drinking.

Color: Clear (152).

Capacities calculated to rim.

Personalization available. See crestring section for information and ordering.

Withstands temperatures from -40° to 99°C.



CODE	500CW	800CW	850CW	950CW	1200CW	1600CW
MAX DIAMETER	5,7 cm	6,7 cm	8,6 cm	7 cm	7,5 cm	7,9 cm
MAX HEIGHT	9,2 cm	10,2 cm	9,7 cm	11,1 cm	13,2 cm	14,6 cm
FULL SIZE CAMRACK®	49S318	36S418	25S418	36S418	36S434	25S534
CAPACITY TO RIM	160 mL	237 mL	269 mL (heavy wall)	284 mL	384 mL	503 mL
CASE PACK	48	48	48	48	48	48

CamView® Camliter Beverage Decanters

- Ideal for serving juice or wine on buffet lines or table side.
- Spill-proof, snap tight flat lids included to protect content from cross contamination.
- Pour Spout Lid available to protect content while allowing free pour.
- Light-weight, dent and scratch resistant.
- Made of impact resistant material.
- NSF Listed- Camliter with Flat Lid.

Color: Clear (135).

Lid Color: White (148).

Personalization available. See crestring section for information and ordering.

Withstands temperatures from -40° to 71°C.

Lids not NSF listed.



CODE	CAPACITY	HEIGHT
------	----------	--------

Camliters complete with lids: (WW1000L, WW250L)

WW1500	1,5 L	25,4 cm
WW1000	1	24,8
WW500	0,5	20
WW250	0,25	15,9

Lids

WW1000LS	(lid w/pour spout for 1,5 L, 1 L, and 0,5 L)
WW1000L	(lid for 1,5 L, 1 L and 0,5 L)
WW250L	(lid for 0,25 L)

Case Pack: 12 Pour Spout Lid must be ordered separately.



BEVERAGE DISPENSER, PAIL WITH BAIL & SWIRL BOWLS®

21 L Beverage Dispenser

- Perfect for mixing and serving concentrated beverages.
- Standard and metric graduations are printed on dispenser.
- Impact resistant polyethylene withstands temperatures from -40° to 70°C.

CODE	CAPACITY
DSPR6	21 L

Case Pack: 1

Color: White (148).
 Personalization available. See cresting section for information and ordering.



DSPR6
Capacity: 21 L

Pail with Bail – Poly

- A large, multi-purpose, 21 L pail, ideal for mixing, storing and transporting.
- Durable polyethylene withstands temperatures from -40° to 70°C, and is stain resistant.
- Snap-tight, thumb tab cover sold separately.

CODE	CASE PACK
PWB22	6
RFSC12 (cover)	6

Color: White (148).



All graduations are approximate.

Swirl Bowls

- Ideal for hot or cold side dishes, desserts, dips, or fruit.
- Fits on a plate or stacks in place on a buffet station.
- Available in virtually unbreakable polycarbonate or break resistant SAN.

Colors:
 SRB5CW and SRB13CW: Clear (135), Black (110), White (148).
 SRB5 and SRB13: Clear (152), Black (110), White (148).
 Made of (P.E.T.) material.



CLSRB5 Disposable lid not NSF.



Disposable lid available



SRB13CW



SRB5CW

CODE	CAPACITY	CASE PACK
Polycarbonate		
SRB5CW	148 mL	24
SRB13CW	384	24
SAN		
SRB5	148	24
SRB13	384	24
Disposable Lid		
CLSRB5	—	1,000

Disposable Lid Color: Clear (152).

POLYCARBONATE WINE BUCKETS, PUNCH BOWLS & BUD VASE

Wine Buckets

- Chill and showcase wine or champagne.
- Tough Polycarbonate won't crack or break and is easy to clean.

Color: Clear (135).

Personalization available. See cresting section for information and ordering.



CODE	DIMENSION D x H
WC100CW	20,3 x 23,2 cm
WC100CWNH (w/o handles)	20,3 x 22,9

Case Pack: 1



WC100CW

Pebbled Pedestal Punch Bowls

- Perfect for parties, weddings and receptions.
- Made of virtually unbreakable Polycarbonate.
- Attractive pebbled exterior is scratch resistant and smooth interior is easy to clean.

Color: Pebbled (176).

Capacities are calculated to rim.

Personalization not available.



CODE	INSIDE DIAMETER	APPROX. CAPACITY	CASE PACK
PPB15	38,1 cm	10,6 L	1
PPB18	45,7	19,1	1
PPB23	58,4	37,8	1

Bud Vase

- Ideal for dining rooms, cafeteria tables and patient or room service trays.
- Made of virtually unbreakable Polycarbonate.
- Fill with a fresh rose bud or a colorful faux flower.

Colors: Clear (135), White (148).



White (148)

Clear (135)



CODE	DESCRIPTION	CASE PACK
BV6CW	15,24 cm bud vase	12

FOOD PRESENTATION

Deli Crocks & Platter

ShowFest® Display Bowls & Trays

Polycarbonate Bowls

Bell Shaped, Budget & Fiberglass Bowls

Polycarbonate Display Covers & Trays

Crocks & Ladles

Polycarbonate Serving Spoons,
Tongs & High Heat Cantensils®

Lugano® Tongs

Polycarbonate Shakers/Dredges & Condiment Jars



DELI CROCKS & PLATTER

- Prep, store and serve all in one with contemporary style at an economical price.
- Crock and platter are made of SAN, making them impact, stain and chip resistant.
- Ideal for supermarket delis, sandwich shops, buffets and catered events.
- Handled covers are made of crystal clear, virtually unbreakable polycarbonate.

Crock and Platter Colors: Clear (152), Black (110), White (148), Red (404).

Crock Cover Color: Clear (135).

Deli Crock covers are covered by the following U.S. Patents D 504,283 S, D 503,871 S & D 494,419 S. Scalloped Food Service Cover is covered by the following U.S. Patent D 509,705 S.

DCC5, DCC10 are NSF Component.



Prep, stack, store and serve all in one.



Interstacking saves storage space.



Avoid cross contamination and keep food fresh by using clear cover with handle.



Lid can be used as a riser to provide additional height on the buffet table or in a deli display case.



Cover doubles as a false bottom for presentation and to reduce waste.

Crocks & Platter



CODE	DC5	DC10	DP15
DESCRIPTION	Crock	Crock	Platter
DIMENSIONS W x L x H	17,5 x 26 x 8 cm	26,5 x 33,5 x 8 cm	40 x 30,5 x 5,5 cm
APPROXIMATE CAPACITY	2 L	4,6 L	3,2 L

Case Pack: 6

Covers



CODE	DCC5 fits DC5	DCC10 fits DC10
DIMENSIONS W x L x H	15 x 23,8 x 3,5 cm	24 x 31 x 3,5 cm
APPROXIMATE CAPACITY	0,85 L	1,9 L

Case Pack: 6

SHOWFEST® DISPLAY BOWLS & TRAYS

- Showcase cold deli, buffet and salad bar items.
- Made from SAN for impact, stain, break & chip resistance.
- Variety of shapes & sizes to make the best use of display area.

Colors: Black (110), White (148).

Personalization not available.



Scalloped Ovals



CODE	SFV1015
DIM. W x L x H	25,4 x 38 x 5 cm
APPROX. CAPACITY	2,8 L
Case Pack:	6



Scalloped Rectangles



CODE	SFR1012
DIM. W x L x H	25,4 x 31,8 x 7,6 cm
APPROX. CAPACITY	4,3 L
Case Pack:	6

Octagonals



CODE	SFG1012	SFG1015	SFG820	SFG1220
DIM. W x L x H	25,4 x 30,5 x 5 cm	25,4 x 38 x 5 cm	20,3 x 50,8 x 5 cm	30,5 x 50,8 x 5 cm
APPROX. CAPACITY	2,8 L	3,3 L	3,7 L	5,8 L
Case Pack:	6			

Triangles



CODE	SFT1010	SFT1212	SFT1515
DIM. W x L x H	25,4 x 30,5 x 6,4 cm	30,5 x 38 x 6,4 cm	38 x 50,8 x 6,4 cm
APPROX. CAPACITY	1,9 L	2,8 L	4,2 L
Case Pack:	6		

POLYCARBONATE BOWLS

Round Pebbled Bowls

- Textured on the outside for an elegant look, smooth on the inside for easy cleaning.
- Made of virtually unbreakable polycarbonate for years of dependable service.
- Ideal for fruit, salads, snacks and desserts.

Color: Pebbled (176).

Capacities are calculated to rim.



Ribbed Bowls

- Stylish, contemporary appearance for a dramatic presentation.
- Made of virtually unbreakable polycarbonate that won't break like glass.
- Bowls are durable and lightweight. Will not chip and crack like acrylic.
- Resistant to stains, acids and odors.

Colors: Clear (135), Black (110), White (148).

Rectangular Ribbed Bowls are not available in White (148).

Capacities are calculated to rim.



Round Pebbled Bowls



CODE	PSB6	PSB8	PSB10	PSB12
INSIDE DIAMETER	15,2 cm	20,3 cm	25,4 cm	30,5 cm
APPROXIMATE CAPACITY	556 mL	1,5 L	3 L	5,5 L
CASE PACK	12	12	12	12

Round Pebbled Bowls



CODE	PSB15	PSB18	PSB23
INSIDE DIAMETER	38,1 cm	45,7 cm	58,4 cm
APPROXIMATE CAPACITY	10,6 L	19,1 L	37,8 L
CASE PACK	4	4	4

Color: Pebbled (176).

Rectangular Ribbed Bowls



CODE	RSB912CW	RSB1014CW	RSB1419CW
OUTSIDE DIAMETER	22,9 x 30,8 cm	27,3 x 37 cm	36,2 x 49,2 cm
APPROXIMATE CAPACITY	2,7 L	4,7 L	11,3 L
CASE PACK	12	4	4

Rectangular Ribbed Bowls are not available in White (148).

Round Ribbed Bowls



CODE	RSB6CW	RSB8CW	RSB10CW	RSB12CW
INSIDE DIAMETER	15,2 cm	20,3 cm	25,4 cm	30,5 cm
APPROXIMATE CAPACITY	564 mL	1,6 L	3 L	5,5 L
CASE PACK	12	12	12	12



CODE	RSB15CW	RSB18CW	RSB23CW
INSIDE DIAMETER	38,1 cm	45,7 cm	58,1 cm
APPROX. CAPACITY	10,6 L	19,1 L	37,8 L
CASE PACK	4	4	4

BELL SHAPED, BUDGET & FIBERGLASS BOWLS

Polycarbonate Bell-Shaped Pebbled Bowls

- Perfect for showcasing fruits and salads.
- A versatile alternative to Cambro traditional Round Pebbled Bowls.
- Made from virtually unbreakable polycarbonate.

Color: Pebbled (176).

Personalization not available.

Capacities are calculated to rim.



CODE	BSB10	BSB12	BSB18
INSIDE DIAMETER	25 cm	30,5 cm	45,7 cm
APPROX. CAPACITY	2 L	3,8 L	11,8 L
CASE PACK	12	4	4

Budget Salad Bowls

- An economical serving choice for fruit, salads, snacks and desserts.
- Impact resistant FDA approved material resists stains, acids and odors.

Colors: Birch (174), Black (110).

Personalization not available.

Capacities are calculated to rim.



CODE	SB55	SB60	SB80
INSIDE DIAMETER	14,5 cm	15,2 cm	20,3 cm
APPROX. CAPACITY	325 mL	375 mL	925 mL

Case Pack: 72



Fiberglass Bowls

- Combines the look of warm wood grains with the durability of fiberglass.
- Colors won't fade even after years of service and washing.

Color: Dark Basketweave (301).

Personalization not available.

For a swatch of this color and pattern, see Camtray® group section.

Capacities are calculated to rim.



CODE	6F	8F
INSIDE DIAMETER	15,6 cm	20,3 cm
APPROX. CAPACITY	425 mL	925 mL

Case Pack: 12



POLYCARBONATE DISPLAY COVERS & TRAYS

- Display covers protect freshness of pastries, breads and desserts.
- Virtually unbreakable polycarbonate features the upscale look of glass.
- Openings on side or end provide quick and easy access to contents without removing cover.

Display Covers

Color: Clear (135).

Personalization available. See crestring section for information and ordering.

* Dimensions include handle(s).
Handle height is 2,06 cm.

Market Trays

Colors: Salmon (149), Yellow (145), Blue (142), Green (140), White (148), Black (110).

Colors NSF listed for food contact:
White (148), Blue (142), Green (140).

Display Trays

Colors: Clear (135), Black (110).

Personalization not available.

**Special order item not carried in stock – non-returnable.



Display Trays are stackable.
Refer to Market Tray for information.



RD1220CW



RD1220CWH



DD1220BECW



RD1200CW



Display Tray – DT1220CW



Dome with side cut –
DD1220SCW

CODE	APPROXIMATE DIMENSIONS W x L x H*	DESCRIPTION	CASE PACK
Display Covers			
RD1200CW	30,5 x 30,5 x 20,9 cm	Cake cover	1
DD1220CW	55,6 x 37,5 x 20,3	Dome cover	1
DD1220ECW	55,6 x 37,5 x 20,3	Dome w/end cut	1
DD1220BECW	55,6 x 37,5 x 20,3	Dome w/2 ends cut	1
DD1220SCW	55,6 x 37,5 x 20,3	Dome w/side cut	1
DD1826CW	67,9 x 47,9 x 22,5	Dome cover	1
RD926CW	67,2 x 25,4 x 15,9	Rectangular cover	1
RD1220CW	55,6 x 35,9 x 14,9	Rectangular cover	1
RD1220CWH	55,6 x 35,9 x 12,7	Rectangular w/hinge	1
RD1826CW	67,2 x 47,9 x 15,9	Rectangular cover	1
RD1826CWH	67,9 x 47,6 x 13	Rectangular w/hinge	1
Display Tray – Fits with all 1220 covers			
DT1220CW	32,5 x 53	Tray	1
Market Tray – Fits with all 1826 covers			
1826MT**	65,3 x 45,2 x 2,7	Tray	6

CROCKS & LADLES

Crocks

- Ideal for use with salad bars, on buffet tables or at food stations.
- Resists stains and odors caused by vinegar, salad oils, or mayonnaise.
- Made of high impact FDA accepted material.
- Smooth surface is easy-to-clean.

Solid Color Crock Colors: Black (110), Beige (133), Reddish Brown (195).

Clear Crock Color: Clear (152).

Lid Color: White (148).

Personalization available.

See personalization section for details.

* Lids for Solid Color and Clear Crocks are not interchangeable.



Polycarbonate Ladles

- Portion control bowls serve the perfect amount of dressing or food ingredient.
- Angled for easy handling.
- Designed with a side rest so ladles don't slip into crocks or serving bowls.
- Made of virtually unbreakable polycarbonate for years of dependable service.

Colors: Black (110), Beige (133), Clear (135), White (148).

* Cambro's assortment pack is available in black only. It offers 8 imprinted ladles and 4 with no imprinting. The 8 imprints include: 1 Thousand Island, 1 French, 1 House, 1 Italian, 1 Bleu Cheese, 1 Ranch, 1 Low Cal, 1 Caesar. This makes a perfect start-up set for a salad bar.

Custom Order Ladle Imprints – See crestring section for information and ordering. Maximum imprint area is 2,5 x 1,2 cm. Six dozen minimum.

No broken cartons on assortment pack or imprinted ladles. Special order item not carried in stock, non-returnable.



CODE	HEIGHT	TOP DIAMETER	CUT OUT DIAMETER
Solid Color Crock with Lid			
CP12	13,2 cm	12,9 cm	12,1 cm
CP15	11	16,8	15,7
CP27	17,2	16,8	15,6
Clear Color Crock with Lid			
CCP12	13,7	13,3	12,4
CCP15	11,1	17,2	15,9
CCP27	17,5	17,2	15,7

CODE	CAPACITY	CASE PACK
Solid Color Crocks		
CP12	1,1 L w/Lid	12
CP15	1,4 L w/Lid	6
CP27	2,4 L w/Lid	6
Lids for Solid Color Crocks		
CPL12*	Fits Colored CP12 Crock	12
CPL27*	Fits Colored CP15 & CP27	12
Clear Crocks		
CCP12	1,1 L w/Lid	12
CCP15	1,4 L w/Lid	6
CCP27	2,4 L w/Lid	6
Lids for Clear Crocks		
CCPL12*	Fits Clear CCP12 Crock	12
CCPL27*	Fits Clear CCP15 & CCP27	12



Imprinted Ladles shown.

CODE	DESCRIPTION	LENGTH	CAPACITY
LD85	Plain	21,6 cm	25 mL
LD85A*	Assortment	21,6	25
LD105	Plain	26,8	30
LD105A*	Assortment	26,8	30
LD130	Plain	33	30

Case Pack: 12

POLYCARBONATE SERVING SPOONS, TONGS & HIGH HEAT CAMTENSILS®

Polycarbonate Serving Spoons

- Made of virtually unbreakable polycarbonate, polycarbonate spoons won't tarnish, bend or dent.
- A wide handle and molded in thumb rest ensures a solid, ergonomic grip.
- Spoons feature a notched back to rest on pans.
- Spoon capacities are approximate and are not intended for measuring.

Colors: Black (110), Beige (133), Clear (135), Red (404), White (148).

Personalization available. See crestring section for information, ordering and pricing.



Polycarbonate Perforated Serving Spoons



CODE	SPOP10CW	SPOP11CW*	SPOP13CW*
DESCRIPTION	25,5 cm Perforated buffet spoon	28 cm Perforated deli spoon	33 cm Perforated deli spoon
DIMENSIONS	26 x 4,3 cm	28,3 x 7,3 cm	33,3 x 7,3 cm

Case Pack: 12 * Can not be personalized.

Polycarbonate Serving Spoons

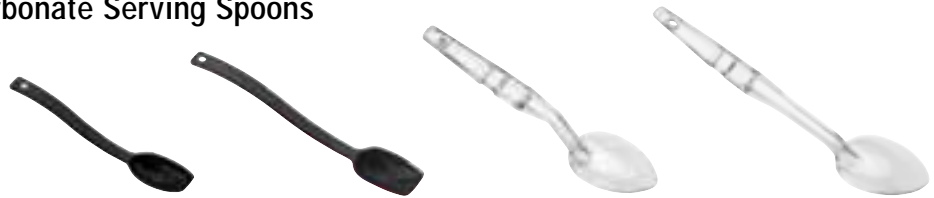

CODE	SP08CW	SP010CW	SP011CW*	SP013CW*
DESCRIPTION	20,5 cm Salad spoon	25,5 cm Buffet spoon	28 cm Deli spoon	33 cm Deli spoon
DIMENSIONS	20,6 x 3,8 cm	26 x 4,3 cm	28,3 x 7,3 cm	33,3 x 7,3 cm

Case Pack: 12 * Can not be personalized.



High Heat Camtensil Spoons and Turners

- Ideal for preparing and serving hot and cold foods.
- Made of a durable high heat material that withstands temperatures from -40° to 149°C.
- Handle includes a hole for hanging when not in use and notches to rest on pans.

Colors: Amber (150), Black (110).

Personalization not available.



High Heat Camtensil Spoons and Turners



CODE	SP013	SPA14
DESCRIPTION	33 cm Solid spoon	35,5 cm Solid turner
DIMENSIONS	33,3 x 7,3 cm	35,9 x 8,9 cm

Case Pack: 12

High Heat Camtensil Perforated Spoons and Slotted Turners



CODE	SPOP13	SPASL14
DESCRIPTION	33 cm Perforated spoon	35,5 cm Slotted turner
DIMENSIONS	33,3 x 7,3 cm	35,9 x 8,9 cm

Case Pack: 12

LUGANO® TONGS

- Colored tongs are made from a durable heat resistant material that withstands temperatures up to 100°C.
- Ideal for serving cold and hot food, even from steam tables.
- Clear tongs are made from virtually unbreakable polycarbonate, which is safe to 99°C.

Lugano Flat and Scallop Grip Tongs

- Easily grasp hard to hold items such as salad greens and tomatoes.
- Scallop Tongs feature an ergonomic design and secure finger grip.
- Flat Tongs are ribbed to provide a secure hold.

Colors: Black (110), Beige (133), Clear (135), Red (404), White (148).

Two year warranty on tongs.



Flat Grip Tongs

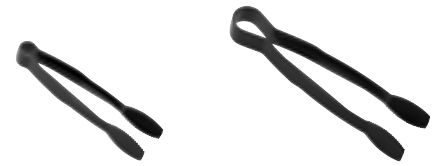

CODE	TG6	TG9
LENGTH	15 cm	23 cm

Case Pack: 12

Scallop Grip Tongs



CODE	6TGS	9TGS	12TGS
LENGTH	15 cm	23 cm	30,5 cm

Case Pack: 12

Lugano Angled and Easy-Grasp Tongs

- Angled tongs feature an ergonomic design that makes it easy to serve a variety of foods.
- Easy-Grasp Tongs provide a secure grip for hard to hold items.

Angled Tong Color: Black (110).
Easy-Grasp Colors: Black (110), Beige (133), Clear (135), White (148).

Two year warranty on tongs.

Angled and Easy-Grasp Lugano Tongs are covered under U.S. Patent D 530,994 S.



Angled Tongs



CODE	TGA8	TGA11
DESCRIPTION	Angled tong	Angled tong
DIMENSIONS	21 cm	27,5 cm

Case Pack: 12



Easy-Grasp Tongs



CODE	TGG6	TGG9
DESCRIPTION	Easy-grasp tong	Easy-grasp tong
DIMENSIONS	17 cm	24 cm

Case Pack: 12

POLYCARBONATE SHAKERS / DREDGES & CONDIMENT JARS

Polycarbonate Shakers / Dredges

- A staple in the kitchen, at the condiment station or on the dining table.
- Clear virtually unbreakable polycarbonate and color coded lids make it easy to identify contents.
- Dishwasher safe and unaffected by food acids.

Shaker Color: Clear (135).

Personalization available. See crestring section for information, ordering and pricing.



96SKRLF
Fine Ground



96SKRLD
Salt & Pepper



96SKRLM
Med. Ground



96SKRLC
Cheese



96SKRLP
Parsley

CODE

LID COLOR

Shakers complete with lids (approx. capacity 300 mL)

96SKRF (w/fine ground lid)	Green (407)
96SKRP (w/parsley lid)	White (148)
96SKRD (w/salt & pepper lid)	Beige (406)
96SKRC (w/cheese lid)	Yellow (405)
96SKRM (w/medium ground lid)	Rose (408)

Shaker Replacement Lids (Shaker Lids are not interchangeable with Camlitter® Lids)

96SKRLF fine ground lid	Green (407)
96SKRLP parsley lid	White (148)
96SKRLD salt & pepper lid	Beige (406)
96SKRLC cheese lid	Yellow (405)
96SKRLM medium ground lid	Rose (408)

Case Pack: 12

Polycarbonate Condiment Jar

- Use to hold condiments such as mustard, ketchup, dressings, jam or salsa.
- Made of clear, virtually unbreakable polycarbonate.
- Lids are slotted to hold serving spoons when not in use.

Color: Clear (135).

Personalization available. See crestring section for information, ordering and pricing.



CODE	APPROXIMATE CAPACITY	SIZE H x D	CASE PACK
Condiment Jar Set			
CJ80CW	240 mL	10,2 x 8,3 cm	24



Trays

Tray Product Guide

Personalization

Polyester Versa Trays

Antimicrobial Camguard® Versa Trays

Polyester Decorated Versa Trays

Polyester Versa Lite Trays

Century Fun Trays

Camtrays®

Non-Slip Versa Camtrays®

Dietary and Camlite® Trays

Polycarbonate Trays

Camtread® / Treadlite™ / Polytread Trays

Wood Trays

Corfu / Capri / Mykonos / Madeira Laminated Trays

Fast Food Trays

Compartment Trays

Market Trays



CHOOSE THE RIGHT TRAY FOR YOUR BUSINESS

Cambro is the global leader in manufacturing trays for the food service industry, offering the largest selection of materials, sizes, colors, shapes and personalization processes. Cambro's breadth of assortment provides the clear choice for the right tray for every need and budget.

Consider the following to select the right tray for your operation:

Step 1: What Will the Tray Be Used For?

In order to choose the correct tray, first identify the correct application.

Service Tray

Used by employees to carry items to serve to guests:

Non-Slip Tray

Patron Tray

Used by customers to carry menu items:

Smooth Surface Tray

Step 2: Who Will Be Using the Tray?

To determine the appropriate tray material, it is critical to identify who will be using the tray.

Children

Students

Military

Office Employees

Wait Staff

Step 3: How Will the Tray Be Used and Washed?

Consider how the tray will be used, and whether it will endure mild or excessive use and abuse. Determine how often the trays will be washed per day.

Extensive:

Wash as often and as frequently as needed

Normal:

Wash up to 3 times per day

Minimal:

Wash once per day

Step 4: Determine the Budget per Tray

Ensure that the correct tray has been selected for the right application. Selecting a low cost tray for a heavy application is not the most cost effective option. Tray pricing varies according to the following factors:

Manufacturing process

Material type and grade

Tray size

Personalization options

Warranty

Step 5: Personalization

Cambro offers high quality personalization on most of the trays that we manufacture. Look for the personalization logo throughout the brochure. 

Step 6: Additional Features to Consider

Evaluate the importance of the following features to determine the best tray for your operation.

Stacking lugs - Promote air circulation for fast drying and perfect stacking

Surface impact resistance

Edge breaking resistance

Scratch and stain resistance

Type of Warranty

Technical test descriptions

All Cambro trays are submitted to an array of tests described to the right. The results are indicated on each tray page under Technical Test Results.



Versa Trays



Versa Trays Anitmicrobial



Versa Lite Trays



Laminated Capri Trays



Laminated Corfu Trays



Laminated Mykonos Trays



Fast Food Trays



Polycarbonate Non-Slip Trays

TESTS DESCRIPTIONS

Thermal Shock Resistance Test:

Test consists of applying a radical temperature change during a short period of time to the tray, by taking out the tray from icy water (0°C) and placing it into boiling water (100°C) and measuring any deformation.

Break Resistance Test:

Test consists of dropping a metal ball from specific heights onto the tray and measuring any deformation.

Scratch Resistance Test:

Observe scratches and abrasions as a result of friction between porcelain dinnerware and the tray surface.

Test consists of moving a porcelain dish placed on tray from left to right under hand pressure and measuring any abrasion on tray surface.

DISHWASHER SAFE DESCRIPTIONS

Extensive: Wash as often and as frequently as needed.

Normal: Wash up to 3 times per day.

Minimal: Wash once per day.

TRAY PRODUCT GUIDE

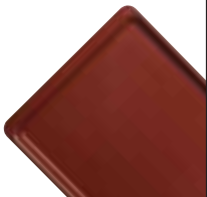
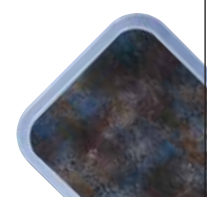
POLYESTER TRAYS					
					
Tray Description	Versa Trays Ecologic Series Page 199	Versa Tray Plus Page 200	Antimicrobial Versa Trays VT/GP Page 201	Versa Trays with Décor GP Page 202	Versa Trays Non-Slip Surface GP Page 203
Material	Natural Material + SMC-High Performance Fiberglass Reinforced Polyester	SMC-High Performance Fiberglass Reinforced Polyester	SMC-High Performance Fiberglass Reinforced Polyester	SMC-High Performance Fiberglass Reinforced Polyester + Melamine Surface	SMC-High Performance Fiberglass Reinforced Polyester + Non-Slip Surface
Surface	Smooth	Smooth	Smooth	Smooth	Non-Slip
Performance	Excellent	Excellent	Excellent	Excellent	Excellent
Recommended Use	(H) (S) (U) (CS) (M)	(H) (S) (U) (CS) (M)	(H) (S) (U) (CS) (M)	(H) (S) (U) (CS) (M)	(H) (S) (U) (CS) (M) (RS)
Personalization	Yes Δ (Personalization Heat Resistance: 90°C.)	No	No	No	Yes Δ (Heat resistance: 80°C)
Years Warranted**	5	5	5	5	2
Stacking* Lugs	Yes	Yes	Yes	Yes	Yes
Dishwasher Safe	Yes – Extensive	Yes – Extensive	Yes – Extensive	Yes – Extensive	Yes – Extensive
Chemical Resistance	Excellent	Excellent	Excellent	Excellent	Good
Drying Test	Excellent	Excellent	Excellent	Excellent	Excellent
Thermal Shock Resistance	Excellent	Excellent	Excellent	Excellent	Excellent
Break Resistance	Excellent	Excellent	Excellent	Excellent	Excellent
Scratch Resistance	Excellent	Excellent	Excellent	Excellent	Good
Stain Resistance	Excellent	Excellent	Excellent	Excellent	Good
Heat Resistance	-40° to +140°C ‡	-40° to +140°C ‡	-40° to +140°C ‡	-40° to +90°C ‡	-40° to +80°C ‡
Number of Sizes	5	5	6	3	4
Number of Shapes	4	4	3	1	1
Number of Colors	4	3	1	15	5

* Stacking lugs allow free air circulation and perfect stacking.

** Prorated warranty against manufacturer's defects.

‡ Not recommended for heated cart.

Δ Contact your Cambro representative for pricing.

If you are using Thermo-Chemical Disinfection Equipment, please contact us. We will assist you finding the right tray for your application.

Icon Directory for Recommended Use:



Hospitals



Schools



Universities



Canteens /
Cafeterias /
Self-Serve



Military



Hotel /
Room Service



Banquet
Service



Restaurants /
Cafes



Bars /
Clubs /
Pubs



Catering



Brasseries



Prisons /
Corrections



Home
Meal Delivery



Quick Serve
Restaurants



Food Courts /
Snack Shops







Deli / Buffet
Displays



Kitchen
Operation

TRAY PRODUCT GUIDE

POLYESTER TRAYS					
					
Tray Description	Versa Trays VT/GP Pages 204-205	Versa Lite Trays VL/GL Pages 206-207	Century Fun Trays: Versa Trays VT/GP Versa Lite Trays VL/GL Page 208	Non-Slip Versa Lite Trays VL/GL Page 209	Versa Lite Trays with Non-Slip Rubber Surface VL/GL Page 210
Material	SMC-High Performance Fiberglass Reinforced Polyester	SMC-Standard Performance Fiberglass Reinforced Polyester	SMC-High or Standard Performance Fiberglass Reinforced Polyester	SMC-Standard Performance Fiberglass Reinforced Polyester + Non-Slip Surface	SMC-Standard Performance Fiberglass Reinforced Polyester + Non-Slip Rubber Surface
Surface	Smooth	Smooth	Smooth	Non-Slip	Non-Slip Rubber
Performance	Excellent	Excellent	Excellent	Excellent	Excellent
Recommended Use	(H) (S) (U) (CS) (M)	(H) (S) (U) (CS) (M) (C) (RS)	(H) (S) (U) (CS) (M)	(H) (S) (U) (CS) (M) (RS)	(BS) (RC) (BC) (C) (B)
Personalization	Yes Δ (Personalization Heat Resistance: 90°C.)	Yes Δ (Heat resistance: 90°C)	Yes Δ (Heat resistance: 90°C)	Yes Δ (Heat resistance: 80°C)	No
Years Warranted**	5	3	3	2	3
Stacking* Lugs	Yes	Yes	Yes	Yes	Yes
Dishwasher Safe	Yes – Extensive	Yes – Normal	Yes – Normal	Yes – Normal	Yes – Normal
Chemical Resistance	Excellent	Good	Good	Good	Good
Drying Test	Excellent	Excellent	Excellent	Excellent	Excellent
Thermal Shock Resistance	Excellent	Good	Good	Good	Good
Break Resistance	Excellent	Good	Good	Good	Good
Scratch Resistance	Excellent	Good	Good	Good	Good
Stain Resistance	Excellent	Good	Good	Good	Good
Heat Resistance	-40° to +140°C ‡	-40° to +130°C ‡	-40° to +90°C ‡	-40° to +80°C ‡	-40° to +100°C ‡
Number of Sizes	22	14	1	4	7
Number of Shapes	9	6	1	3	3
Number of Colors	12	8	5	4	2

* Stacking lugs allow free air circulation and perfect stacking.

** Prorated warranty against manufacturer's defects.

‡ Not recommended for heated cart.

Δ Contact your Cambro representative for pricing.

If you are using Thermo-Chemical Disinfection Equipment, please contact us. We will assist you finding the right tray for your application.

Materials Review

POLYESTER TRAYS

- Versa Tray Ecologic Series
- Versa Tray Plus
- Versa Tray Antimicrobial
- Versa Trays
- Versa Trays with Décor (1)
- Versa Non-Slip Versa Trays
- Versa Century Fun

High performance polyester trays are made of rugged reinforced mat with long fibers and additional fiberglass to provide extremely high shock-resistance. Colored isophthalic polyester resin offers high chemical and UV-resistance.





- (1) Personalized Versa Trays and Versa Trays with Décor have a Melamine Resin Layer on top increasing protection against stains, abrasions and scratches.

VERSA LITE TRAYS

- VL/GL Century Fun
- VL/GL Trays
- VL/GL Trays with Non-Slip Surface
- VL/GL Trays with Non-Slip Rubber Surface

Standard performance polyester trays are made of fiberglass and standard polyester resin.

TRAY PRODUCT GUIDE

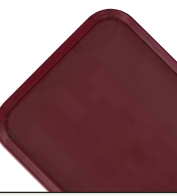
	FIBERGLASS TRAYS				POLYCARBONATE TRAYS	
						
Tray Description	Camtrays® Pages 211-215	Non-Slip Versa Camtrays Page 216	Dietary Trays Page 217	Camlite Trays Page 217	Polycarbonate Trays Page 218	Polycarbonate Trays with Non-Slip Surface Page 218
Material	Fiberglass Layers + Polyester Resin	Fiberglass Layers + Polyester Resin + Non-Slip Surface	Fiberglass Layers + Polyester Resin	Fiberglass Layers + Polyester Resin	Polycarbonate	Polycarbonate + Non-Slip Surface
Surface	Smooth	Non-Slip	Smooth	Smooth	Textured	Non-Slip
Performance	Excellent	Excellent	Excellent	Excellent	Excellent	Excellent
Recommended Use	(H) (S) (U) (CS) (M) (RS)	(S) (U) (CS) (M) (RS)	(H) (S) (U) (CS) (M) (RS)	(H) (S) (U) (CS) (M) (RS)	(S) (U) (CS) (M) (QS) (FC)	(S) (U) (CS) (M) (QS) (FC) (RC) (B) (RS) (H)
Personalization	Yes Δ (Personalization Heat Resistance: 100°C.)	Yes Δ (Personalization Heat Resistance: 80°C.)	No	No	No	No
Years Warranted**	5	2	1	3	3	3
Stacking* Lugs	Yes	Yes	Yes	Yes	Yes	Yes
Dishwasher Safe	Yes – Extensive	Yes – Extensive	Yes – Extensive	Yes – Extensive	Yes – Extensive	Yes – Extensive
Chemical Resistance	Good	Good	Good	Good	Good	Good
Drying Test	Excellent	Excellent	Excellent	Excellent	Excellent	Excellent
Thermal Shock Resistance	Excellent	Excellent	Excellent	Excellent	Excellent	Excellent
Break Resistance	Excellent	Excellent	Good	Good	Excellent	Excellent
Scratch Resistance	Excellent	Good	Good	Good	Very Good	Good
Stain Resistance	Excellent	Good	Excellent	Excellent	Very Good	Good
Heat Resistance	-10° to +100°C ‡	-40° to +80°C ‡	-10° to +100°C ‡	-10° to +100°C ‡	-40° to +99°C ‡	-40° to +82°C ‡
Number of Sizes	40	2	6	6	2	2
Number of Shapes	7	2	1	2	2	1
Number of Colors	55	3	55	9	2	2

* Stacking lugs promote air circulation and perfect stacking.

** Prorated warranty against manufacturer's defects.

Δ Contact your Cambro representative for pricing.

‡ Not recommended for heated cart.

Materials Review

FIBERGLASS TRAYS

- Camtray
- Non-Slip Versa Camtray
- Dietary Trays
- Camlite Trays

Made of rugged fiberglass interior to provide a tough inner foundation and smooth surface, coupled with polyester resin to resist impact and stains.





POLYCARBONATE TRAYS

- Polycarbonate Trays
- Made of highly durable, virtually unbreakable polycarbonate.

- Polycarbonate Trays with Non-Slip Surface

Made of highly durable, virtually unbreakable polycarbonate. The non-Slip, clear textured, surface is scratch resistant.

TRAY PRODUCT GUIDE

	FIBERGLASS TRAYS		POLYPROPYLENE TRAYS	WOOD TRAYS	
					
Tray Description	Camtread® Trays Page 219	Treadlite™ Trays Page 220	Polytread® Trays Page 220	Wood Trays with Smooth Surface Page 221	Wood Trays with Non-Slip Surface Pages 222
Material	Fiberglass Layers + Polyester Resin + Non-Slip Rubber Surface	Fiberglass Layers + Polyester Resin + Non-Slip Rubber Surface	Polypropylene + Non-Slip Rubber Surface	Veneer Beechwood	Veneer Beechwood or Mahogany + Non-Slip Surface
Surface	Non-Slip Rubber	Non-Slip Rubber	Non-Slip Rubber	Smooth	Non-Slip
Performance	Excellent	Good	Good	Good	Good
Recommended Use	BS RC BC C B	RC BC B	RS RC BC	BS RC C	BS RC BC C B
Personalization	Yes Δ	No	No	No	Yes
Years Warranteed**	5	1	1	3	3
Stacking* Lugs	Yes	Yes	Yes	No	No
Dishwasher Safe	Yes – Extensive	Yes – Minimal	Yes – Minimal	Yes – Normal	Yes – Minimal
Chemical Resistance	Good	Good	Good	Excellent	Good
Drying Test	Excellent	Good	Good	Good	Good
Thermal Shock Resistance	Excellent	Good	Good	Good	Good
Break Resistance	Good	Good	Good	Good	Good
Scratch Resistance	Excellent	Good	Good	Good	Good
Stain Resistance	Good	Good	Good	Good	Good
Heat Resistance	-10° to +100°C ‡	-10° to +80°C ‡	-10° to +80°C ‡	-10° to +100°C ‡	-10° to +100°C ‡
Number of Sizes	16	2	6	14	16
Number of Shapes	5	1	2	4	5
Number of Colors	2	2	2	1	2

* Stacking lugs promote air circulation and perfect stacking.

** Prorated warranty against manufacturer's defects.

Δ Contact your Cambro representative for pricing.

‡ Not recommended for heated cart.

Materials Review

FIBERGLASS TRAYS

- Camtread Trays
- Treadlite Trays

Made of rugged fiberglass interior to provide a tough inner foundation and smooth surface, coupled with polyester resin to resist impact and stains.

POLYPROPYLENE TRAYS

- Polytread Trays





Polytread trays have non-slip rubber surface bonded directly into the tray.

WOOD TRAYS

- Smooth Surface
- Clear Non-Slip Surface

Made of several layers of genuine beechwood veneer / mahogany combined with synthetic resin molded under high pressure and temperature. The surface is sealed with a double layer of high pressure melamine to allow regular washing.

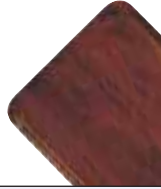
TRAY PRODUCT GUIDE

	LAMINATED TRAYS				POLYPROPYLENE
					
Tray Description	Corfu Laminated Trays with Non-Slip Rubber Surface Page 223	Capri Laminated Trays with Smooth Surface Pages 224-225	Mykonos Laminated Trays with Non-Slip Surface Page 226	Madeira Laminated Trays with Textured Wood Surface Page 227	Fast Food Trays Page 228
Material	Laminate + Non-Slip Rubber Surface	Laminate	Laminate + Non-Slip Surface	Laminate	Polypropylene
Surface	Non-Slip Rubber	Smooth	Non-Slip	Textured	Textured
Performance	Excellent	Good	Good	Good	Good
Recommended Use	CS BS RC BC C	CS RS RC BC C B	BS RS BC BC C B	CS RS RC BC	QS FC
Personalization	Yes†	Yes	Yes	No	Yes
Years Warranted**	3	3	3	3	3
Stacking* Lugs	No	No	No	No	Yes
Dishwasher Safe	Yes – Normal	Yes – Normal	Yes – Minimal	Yes – Normal	Yes – Minimal
Chemical Resistance	Excellent	Excellent	Good	Excellent	Excellent
Drying Test	Good	Good	Good	Good	Good
Thermal Shock Resistance	Good	Good	Good	Good	Good
Break Resistance	Good	Good	Good	Good	Good
Scratch Resistance	Good	Good	Good	Good	Good
Stain Resistance	Good	Excellent	Good***	Excellent	Good
Heat Resistance	-10° to +100°C ‡	-10° to +100°C ‡	-10° to +100°C ‡	-10° to +100°C ‡	-10° to +80°C ‡
Number of Sizes	8	22	15	9	4
Number of Shapes	2	5	3	4	2
Number of Colors	2	11	6	4	14

* Stacking lugs allow free air circulation and perfect stacking.

** Prorated warranty against manufacturer's defects.

*** Limited stain resistance for Birch (E75).

‡ Not recommended for heated cart.

† Only back side of Corfu trays can be personalized.

Materials Review

LAMINATED TRAYS

- Corfu*
- Mykonos
- Capri
- Madeira

Made of compressed layers of melamine saturated paper combined with synthetic resin molded under high pressure and temperature.

The surface is sealed with a double layer of high pressure melamine to allow regular washing.

* Laminated trays have a non-slip rubber surface bonded directly into the tray.





Note: All laminated trays must be dried before stacking.

POLYPROPYLENE TRAYS

- Fast Food Trays

Fast food trays have a textured surface to hide scratches and provides an additional grip to prevent slipping.

TRAY PRODUCT GUIDE

	COMPARTMENT TRAYS				DISPLAY TRAYS
					
Tray Description	Polycarbonate Trays Pages 229-231	ABS Page 229	Heat Resistant Trays Page 232	Co-Polymer Trays Pages 233	Market Trays Page 233
Material	Polycarbonate	ABS	Heat Resistant Plastic	Co-Polymer	Fiberglass Layers + Polyester Resin
Surface	Textured	Textured	Textured	Textured	Smooth
Performance	Excellent	Excellent	Excellent	Excellent	Excellent
Recommended Use	(S) (U) (M) (P)	(S) (U) (M) (P)	(P)	(S) (U) (HD) (P)	(D)
Personalization	No	No	No	No	No
Years Warranteed**	3	2	2	2	3
Stacking* Lugs	Yes	Yes	Yes	Yes	Yes
Dishwasher Safe	Yes – Extensive	Yes – Extensive	Yes – Extensive	Yes – Minimal	Yes – Extensive
Chemical Resistance	Good	Excellent	Very Good	Excellent	Good
Drying Test	Excellent	Excellent	Very Good	Excellent	Excellent
Thermal Shock Resistance	Excellent	Good	Very Good	Good	Excellent
Break Resistance	Excellent	Good	Very Good	Good	Good
Scratch Resistance	Very Good	Very Good	Very Good	Very Good	Good
Stain Resistance	Very Good	Very Good	Very Good	Very Good	Excellent
Heat Resistance	-40° to +99°C ‡	-10° to +82°C ‡	-40° to +149°C	-10° to +80°C ‡	-10° to +100°C ‡
Number of Sizes	8	1	1	8	19
Number of Shapes	7	1	1	8	2
Number of Colors	10***	7	1	7	5

* Stacking lugs allow free air circulation and perfect stacking.

** Prorated warranty against manufacturer's defects.

*** Not available for all tray styles.

‡ Not recommended for heated cart.

Materials Review

COMPARTMENT TRAYS

– Polycarbonate Trays

Made of highly durable, virtually unbreakable polycarbonate.

– ABS Trays

Made of high impact resistance and heat and chemical resistance ABS.

– Co-Polymer Trays

Made of economical pliable and break-resistant co-polymer.

– Heat resistant Trays

Made of heat resistant material.

DISPLAY TRAYS

– Market Trays

Made of high-impact resistant fiberglass that resists odors.

PERSONALIZATION

Value Added Personalization

Promote business to customers and employees alike by placing your custom logo, trademark, slogan or design on our trays.

How to Order

- 1) Select a tray size, color, pattern, or design.
- 2) Provide complete, camera-ready artwork and indicate positioning on the tray.
- 3) According to the tray type, Cambro can produce 1, 2, 3 and 4 color artwork as well as 4 color process artwork.

We require the following:

- a. Electronic artwork file provided on CD-ROM for Mac or PC.

We accept the following file formats:

- Adobe Illustrator, Adobe Photoshop file in JPEG, TIFF or EPS formats.
- File dimensions must equal 100% of reproduction size at 300dpi resolution.

- b. Illustration on paper: The quality of the art must be crisp and scannable. Please specify PANTONE number for each color or indicate if it is a four color process.

- 4) An artist's fee of *** per hour will be charged to any order submitted

without complete, camera-ready artwork. Cambro will contact you if this fee will be charged and will give you an estimated cost.

5) Sample process:

- a. For any new project, a finished sample will be submitted for the customer's approval.
- b. The first sample with a firm purchase order is free. (Plus shipping cost.)
- c. Samples not accompanied by a firm purchase order or requests for more than one sample will be charged a flat rate of:

– Polyester, Fiberglass and Laminated Trays:

*** Net per sample. (Plus shipping cost.)

– Polypropylene Fast Food Trays: *** Net per sample. (Plus shipping cost.)

d. Upon receipt and shipment of a firm purchase order, a credit will be applied to your account for the cost of one sample.

6) Personalization charges apply to both original orders and returns.

POLYESTER TRAYS

Versa Trays VT/GP

Versa Lite Trays VL/GL

- Only the following tray models are suitable for personalization:

Versa Trays:

VT1216, VT1418, VT2632, VT3253, VT3343, VT3343C, VT3646C, VT3753, VT3853, GP0540, GP1070, GP1080, GP3074, GP3980, GP4002, GP4210, GP4004, GP4701, GP4709, GP4853

Versalite Trays:

VL1014, VL1216, VL1418, VL2632, VL3253, VL3343, VL3343C, VL3646C, VL3753, GL0540, GL1070, GL1080, GL3074, GL3980, GL4002, GL4210, GL4701, GL4709

- **Minimum Quantity:** 120 trays per size.
- **Sample Production Time:** 10 business days + delivery and transit time from receipt of camera ready artwork.
- **Order Production Time:** Up to 4-6 weeks + delivery and transit time from the date artwork is approved and the order is confirmed.
- Request for additional samples without a firm purchase order will be charged *** Net per sample. (Plus shipping cost).

Printing Process Applicable:

Four Color Printing Process allows printing of one color or multiple color artwork as well as photo reproduction.

Tray Colors Recommended for Personalized Versa Trays VT/GP:

Speckled Mocha (A21), Sahara (A22), Light Grey (A27), Pearl White (A33), Terrazzo (A86).

For the following colors, please call Cambro Customer Service for artwork review: Magic Yellow (A25), Magic Mint (A26).

Tray Colors Recommended for Personalized Versa Lite Trays VL/GL:

Speckled Smoke (A20), Speckled Mocha (A21), Sahara (A22), Light Grey (A27), Pearl White (A33) and Terrazzo (A86).

Printable Area:

The artwork can cover the flat surface of tray up to 1 cm from the internal tray edge.

Personalization Charges Per Tray:

QUANTITY EACH	ADDITIONAL NET CHARGES
120-300	***
312-996	***
1,008 and up	***

*** Contact your Cambro representative for pricing.



FIBERGLASS TRAYS

Camtray® Trays

- All Camtray sizes can be personalized. (Except compartment trays shown in main Cambro catalog).

Minimum Quantity:

Screen Printing Process: 144 trays per size.
Four Color Printing Process: 72 trays per size.

- **Sample Production Time:** 10 business days + delivery and transit time from receipt of camera ready artwork.
- **Order Production Time:** Up to 4-6 weeks + delivery and transit time from the date artwork is approved and the order is confirmed.
- Request for additional samples without a firm purchase order will be charged *** Net per sample. (Plus shipping cost).

Printing Process Applicable: Screen printing process and four color process.

a. Screen printing process allows printing of artwork with one or multiple colors laying next to each other. This process doesn't allow printing of gradient or photo reproduction. This process is best used with light color artwork on dark tray color.

Printable area: The artwork can cover the total surface of the tray from one edge to the other.

b. Four Color Printing Process allows printing of one color or multiple color artwork as well as photo reproduction. This process can only be used on light color trays. Darker tray color will make the artwork colors go darker.

Tray Colors Recommended for Four Color Printing Process:

Antique Parchment (101), Light Peach (106), Dark Peach (117), White (148), Sky Blue (177), Key Lime (429), Lemon Chiffon (536), Cameo Yellow (537), Cottage White (538).

Printable area: The artwork can cover the flat surface of tray up to 1 cm from the internal tray edge.

Personalization Charges Per Tray:

QUANTITY EACH	ADDITIONAL NET CHARGES
144*-299**	***
300 and up	Free

* Minimum quantity for four color printing process.

** Minimum quantity for screen printing process.

*** Contact your Cambro representative for pricing.



1418

PERSONALIZATION

LAMINATED TRAYS

Corfu, Capri, Mykonos, Madeira

- All Laminated tray sizes can be personalized or produced in any custom color. Custom color matching is treated as a personalization.
- Top and bottom parts of trays can be personalized with the exception of Corfu trays that can only be personalized on the backside of the tray. Personalization cost is per side of the tray.
- **Minimum Quantity:** 120 trays per size.



- **Sample Production Time:** 10 business days + delivery and transit time from receipt of camera ready artwork.
- **Order Production Time:** Up to 4-6 weeks + delivery and transit time from the date artwork is approved and the order is confirmed.

- Request for additional samples without a firm purchase order will be charged *** Net per sample. (Plus shipping cost.)

Printing Process Applicable: Four color process and Custom Color Matching

a. Four Color Printing Process: This process allows the printing of one color or multiple color artwork as well as photo reproduction.

b. Custom Color Matching: Custom color matching is treated as a personalization. To produce any color tray provide Cambro with PANTONE number.

Printable area: The artwork can cover the total surface of tray from one edge to the other. Artwork dimensions must be 4 cm bigger than tray sizes on each side due to trimming. (example: Tray size: 36 x 46 cm – Artwork size: 40 x 50 cm).

Personalization Charges Per Tray:

QUANTITY EACH	ADDITIONAL NET CHARGES
120 and up	***

*** Contact your Cambro representative for pricing.

POLYPROPYLENE TRAYS

Fast Food Trays

- All Fast Food tray sizes can be personalized except 1217FFH.
- **Minimum Quantity:** 288 trays per size.
- **Sample Production Time:** 10 business days + delivery and transit time from receipt of camera ready artwork.
- **Order Production Time:** Up to 4-6 weeks + delivery and transit time



from the date artwork is approved and the order is confirmed.

- Request for additional samples without a firm purchase order will be charged *** Net per sample. (Plus shipping cost.)

Printing Process Applicable:

Hot stamp 1 color process. Due to the application process onto textured tray surface, white can be selected but is not recommended.

Printable area: Artwork cannot exceed a maximum size of 15 x 15 cm.

Personalization Cost:

One-time die charge: *** Net per order.

Additional Net Charges Per Tray:

QUANTITY EACH	ADDITIONAL NET CHARGES
288-767	***
768-1,199	***
1,200-5,999	***
6,000-11,999	***
12,000 and up	***

*** Contact your Cambro representative for pricing.

CAMTREAD TRAYS

Tray Back Personalization and Rubber Surface Embossing

- **Camtread From USA:** Tray Back Personalization only on 1600CT. Rubber surface embossing all Camtread sizes.
- **Camtread From Europe:** Sizes Available: 1100CT, 1400CT, 1600CT and 1800CT
- **Sample Production Time:** 10 business days + delivery and transit time from receipt of camera ready artwork.
- **Order Production Time:** Up to 4-6 weeks + delivery and transit time from the date artwork is approved and the order is confirmed.

- Request for additional samples without a firm purchase order will be charged *** Net per sample. (Plus shipping cost).

Tray Back Personalization Printing Process Applicable:

Four Color Printing Process allows printing of one color or multiple color artwork as well as photo reproduction.

Camtread From USA: White trays are recommended for tray back personalization.

Printable area: The artwork can cover the flat surface of tray up to 2,54 cm from the external tray edge.

Personalization Charges Per Tray:

QUANTITY EACH	ADDITIONAL NET CHARGES
Camtread From USA	
72-144	***
145-288	***
289-432	***
433 and up	Free
Camtread From Europe	
120 and up	***

Rubber Surface Embossing

- **Electronic File Format:** Adobe Illustrator EPS formats.

Embossing Process Printable Area:

The artwork can cover the surface of the tray up to 2,54 cm from the internal tray of edge.

Embossing Personalization Charge Per Tray:

QUANTITY EACH	ADDITIONAL NET CHARGES
Camtread From USA	
72 and up	***
Camtread From Europe	
156 and up	***

*** Contact your Cambro representative for pricing.

POLYESTER VERSA TRAYS – ECOLOGIC SERIES

SPECIFICATIONS

Material	Natural material + polyester
Surface Characteristic	Smooth
Performance	Excellent
Stacking Lugs	Yes
Dishwasher Safe	Yes – Extensive
Chemical Resistance	Excellent
Drying Test	Excellent
Shock Resistance	Excellent
Break Resistance	Excellent
Scratch Resistance	Excellent
Stain Resistance	Excellent
Heat Resistance	-40° to +140°C ‡



PRORATED

‡ Not for use in heated carts.

RECOMMENDED USE

High Traffic / Frequent Use

- Hospitals
- Schools
- Universities
- Canteens / Cafeterias / Self-Serve
- Military



High Profile Shape



Low Profile Shape



Low Profile Design Shape



Flat Edge Shape



Personalization: Contact your Cambro representative for pricing.

Made with resin derived from natural materials.

Average 20% lighter weight than the standard Versa Tray. Makes handling easy and convenient.

High performance polyester tray with reinforced corners and edges for superior protection against impact.

GPE4002



Stacking lugs keep trays stacked securely in place and ensure proper air flow.

CODE	SIZE
Versa Trays – High Profile Shape	
VTE1418	35,5 x 45,7 cm
VTE3343	33 x 43
Versa Trays – Low Profile Shape	
VTE3253	32,5 x 53
VTE3753	37 x 53
Versa Century™ – Low Profile Design Shape	
VTE3646C	35,5 x 45,7
Versa Trays – Flat Edge Shape	
GPE0540	34,4 x 46
GPE3980	37 x 53
GPE4002*	32,5 x 53
GPE4004**	32,5 x 53

Case Pack: 12

* Designed with reinforced corners for automatic off-stacking onto conveyor belt dishwashers.

** Textured top surface to reduce sliding of dishes. Not available in (A72).

*** Charcoal color A72 will show scratches if not handled properly.

Only available from Cambro European Logistics (CEL), Germany and Cambro Özyay Turkey.

Minimum quantity order from CEL: Non-stock item 240 pieces. No broken carton.

Tray Colors:



A21

Speckled Mocha

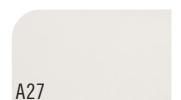

A27

Light Grey



A72

Charcoal***



A86

Terrazzo

POLYESTER VERSA TRAYS PLUS

SPECIFICATIONS

Material	SMC – high performance fiberglass reinforced polyester
Surface Characteristic	Smooth
Performance	Excellent
Stacking Lugs	Yes
Dishwasher Safe	Yes – Extensive
Chemical Resistance	Excellent
Drying Test	Excellent
Shock Resistance	Excellent
Break Resistance	Excellent
Scratch Resistance	Excellent
Stain Resistance	Excellent
Heat Resistance	-40° to +140°C ‡



PRORATED

‡ Not for use in heated carts.

Only available from Cambro European Logistics (CEL), Germany and Cambro Özyay Turkey.

RECOMMENDED USE

High Traffic / Frequent Use

- Hospitals
- Schools
- Universities
- Canteens / Cafeterias / Self-Serve
- Military

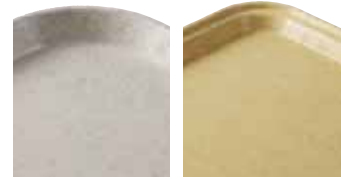

High Profile Shape

Low Profile Shape



Low Profile Design Shape

Flat Edge Shape



GP4002

Easy Care

Dishwasher safe - wash as often and as frequently as needed.

Stacking lugs keep trays stacked securely in place and ensure proper air flow.

Long Lasting

Increased scratch resistance.

Proprietary material blend reduces scratch visibility.

Reinforced corners and edges protect and strengthen the tray.



Brick Red

Black

Brown

CODE	SIZE
Versa Trays – High Profile Shape	
VT1418	35,5 x 45,7 cm
VT3343	33 x 43
Versa Trays – Low Profile Shape	
VT2632	32,5 x 26,5
VT3253	32,5 x 53
VT3753	37 x 53
Versa Century™ – Low Profile Design Shape	
VT3646C	35,5 x 45,7
Versa Trays – Flat Edge Shape	
GP1070	32,5 x 26,5
GP3980	37 x 53
GP4002	32,5 x 53
GP4004	32,5 x 53

Case Pack: 12 Minimum quantity order from CEL: 240 pieces.

ANTIMICROBIAL CAMGUARD® VERSA TRAYS

SPECIFICATIONS

Material	SMC – high performance fiberglass reinforced polyester
Surface Characteristic	Smooth
Performance	Excellent
Stacking Lugs	Yes
Dishwasher Safe	Yes – Extensive
Chemical Resistance	Excellent
Drying Test	Excellent
Shock Resistance	Excellent
Break Resistance	Excellent
Scratch Resistance	Excellent
Stain Resistance	Excellent
Heat Resistance	-40° to +140°C ‡



‡ Not for use in heated carts.

RECOMMENDED USE

High Traffic / Frequent Use

- Hospitals
- Schools
- Universities
- Canteens / Cafeterias / Self-Serve
- Military

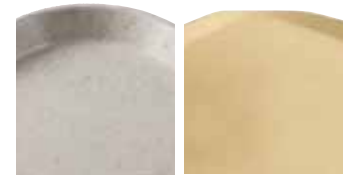

High Profile Shape

Low Profile Design Shape



Flat Edge Shape

Only available from Cambro European Logistics (CEL), Germany and Cambro Özyay Turkey.

camguard
ANTIMICROBIAL TRAYS

Trays have built-in antimicrobial properties to protect against mildew growth and bacterial odors. This protection will not wash or wear off.

Unprotected Surface versus Camguard Treated Surface 24 Hour Test

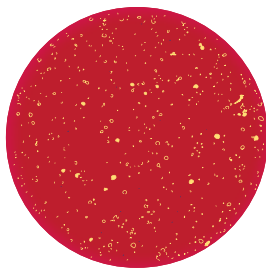

Untreated

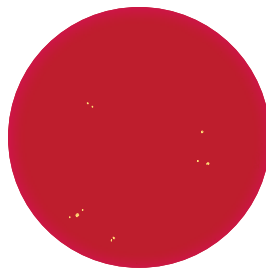

Treated with Camguard



CODE	SIZE
Versa Trays – High Profile Shape	
VT1418AB	35,5 x 45,7 cm
VT3343AB	33 x 43
Versa Century™ Trays – Low Profile Design Shape	
VT3646CAB	35,5 x 45,7
VT3343CAB	32,9 x 43
Versa Trays – Flat Edge Shape	
GP1070AB*	32,5 x 26,5
GP1080AB*	37 x 26,5
GP3980AB*	53 x 37
GP4002AB*	53 x 32,5

Case Pack: 12

Minimum quantity order from CEL: 240 pieces.

* Designed with reinforced corners for automatic off-stacking onto conveyor belt dishwashers.



Innovative low profile and low corner design increases space utilization of tray surface and customer comfort while eating.



Reinforced polyester corners provide superior corner and edge protection against impact.



Stacking lugs keep trays stacked securely in place and ensure proper air flow.

Tray Color:

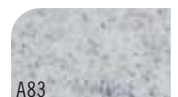

A83

Granite

POLYESTER DECORATED VERSA TRAYS WITH SMOOTH SURFACE

SPECIFICATIONS

Material	SMC – high performance fiberglass reinforced polyester + melamine surface
Surface Characteristic	Smooth
Performance	Excellent
Stacking Lugs	Yes
Dishwasher Safe	Yes – Extensive
Chemical Resistance	Excellent*
Drying Test	Excellent
Shock Resistance	Excellent
Break Resistance	Excellent
Scratch Resistance	Excellent
Stain Resistance	Excellent
Heat Resistance	-40° to +90°C‡



PRORATED

‡ Not for use in heated carts.

* If you are using Thermo-Chemical Disinfection Equipment, please contact us. We will assist you finding the right tray for your application.

Only available from Cambro European Logistics (CEL), Germany and Cambro Özyay Turkey.

RECOMMENDED USE

High Traffic / Frequent Use

- Hospitals
- Schools
- Universities
- Canteens / Cafeterias / Self-Serve
- Military



Flat Edge Shape



CODE	SIZE	CASE PACK
Versa Trays – Flat Edge Shape		
GP0540*	46 x 34,4 cm	12
GP3980*	53 x 37	12
GP4002*	53 x 32,5	12
GP4004	53 x 32,5	12

* Designed with reinforced corners for automatic off-stacking onto conveyor belt dishwashers.

Patterns and Tray Base Colors:



B98
Pebbled Grey on
Terrazzo Tray



B21
Graffiti on
Light Grey Tray



B99
Pebbled Black on
Light Grey Tray



B33
Pearl White on
Pearl White Tray

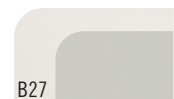

B27
Light Grey on
Light Grey Tray

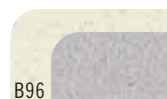

B96
Pebbled White on
Terrazzo Tray

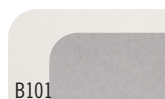

B101
Brushed Steel on
Light Grey Tray



B100
Pebbled Black on
Terrazzo Tray

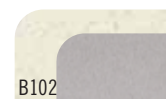

B102
Brushed Steel on
Terrazzo Tray

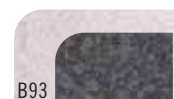

B93
Titan on
Granite Tray

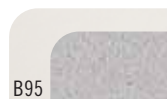

B95
Pebbled White on
Light Grey Tray



B97
Pebbled Grey on
Light Grey Tray

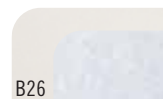

B26
Aqua on
Light Grey Tray



B22
Sahara on
Sahara Tray



B31
Lava on
Speckled Blue Tray

POLYESTER DECORATED VERSA TRAYS WITH NON-SLIP SURFACE

SPECIFICATIONS

Material	SMC – high performance fiberglass reinforced polyester + Non-Slip surface
Surface Characteristic	Non-Slip
Performance	Excellent
Stacking Lugs	Yes
Dishwasher Safe	Yes – Extensive
Chemical Resistance	Good
Drying Test	Excellent
Shock Resistance	Excellent
Break Resistance	Excellent
Scratch Resistance	Good
Stain Resistance	Good
Heat Resistance	-40° to +80°C‡



‡ Not for use in heated carts.

Personalization: Contact your Cambro representative for pricing.

RECOMMENDED USE

High Traffic / Frequent Use

- Hospitals
- Schools
- Universities
- Canteens / Cafeterias / Self-Serve
- Military



Flat Edge Shape

Only available from Cambro European Logistics (CEL), Germany and Cambro Özay Turkey.

CODE	DIMENSIONS	CASE PACK
Versa Trays – Flat Edge Shape		
GP3980NS*	53 x 37 cm	12
GP4002NS*	53 x 32,5	12
GP0540NS*	46 x 34,4	12
GP1080NS*	37 x 26,5	12

* Designed with reinforced corners for automatic off-stacking onto conveyor belt dishwashers.



Patterns and Tray Base Colors:



B22
Sahara on Sahara Tray



B93
Titan on Granite Tray



B31
Lava on Speckled Blue Tray

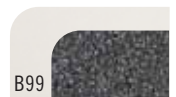

B99
Pebbled Black on Light Grey Tray



B100
Pebbled Black on Terrazzo Tray

POLYESTER VERSA TRAYS WITH SMOOTH SURFACE

SPECIFICATIONS

Material	SMC – High Performance Fiberglass Reinforced Polyester
Surface Characteristic	Smooth
Performance	Excellent
Stacking Lugs	Yes
Dishwasher Safe	Yes – Extensive
Chemical Resistance	Excellent
Drying Test	Excellent
Shock Resistance	Excellent
Break Resistance	Excellent
Scratch Resistance	Excellent
Stain Resistance	Excellent
Heat Resistance*	-40° to +140°C ‡



PRORATED

‡ Not for use in heated carts.
Personalization, see page 197.
* Personalization Heat Resistance: 90°C.

RECOMMENDED USE

High Traffic / Frequent Use

- Hospitals
- Schools
- Universities
- Canteens / Cafeterias / Self-Serve
- Military

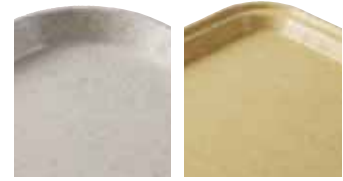

High Profile Shape Low Profile Shape



Low Profile Design Shape Flat Edge Shape

Only available from Cambro European Logistics (CEL), Germany and Cambro Özyay Turkey.

CODE	SIZE	CASE PACK
Versa Trays – High Profile Shape		
VT1216	30,5 x 41,5 cm	12
VT1418	35,5 x 45,7	12
VT1418TR - Trapezoid	35,5 x 45,7	12
VT1520	38 x 51,5	12
VT3343	33 x 43	12

Versa Trays – High Profile Shape



CODE	SIZE	CASE PACK
Versa Trays – Low Profile Shape		
VT2632	32,5 x 26,5 cm	12
VT3253	32,5 x 53	12
VT3753	37 x 53	12
VT3853	37,5 x 53	12

Versa Trays – Low Profile Shape



CODE	SIZE	CASE PACK
Versa Century™ Trays – Low Profile Design Shape		
VT3646C	35,5 x 45,7 cm	12
VT3343C	33 x 43	12

Versa Century Trays – Low Profile Design Shape



Innovative low profile and low corner design increases space utilization of tray surface and customer comfort while eating.

POLYESTER VERSA TRAYS WITH SMOOTH SURFACE

CODE	SIZE	CASE PACK
Versa Trays – Flat Edge Shape		
GP0540*	46 x 34,4 cm	12
GP1070*	32,5 x 26,5	12
GP1080*	37 x 26,5	12
GP3074	45 x 32	12
GP3788	39 x 51	12
GP3980*	53 x 37	12
GP4002*	53 x 32,5	12
GP4004**	53 x 32,5	12
GP4701	42,5 x 32,5	12
GP4709	46 x 32,5	12
GP4856*	34,5 x 23	12

*Designed with reinforced corners for automatic off-stacking onto conveyor belt dishwashers.

**Textured top surface to reduce sliding of dishes. Not available in (A72).

STOCK PRODUCTS & COLORS AVAILABLE IN OUR EUROPEAN WAREHOUSE

GP0540: (A21), (A22), (A27), (A72), (A83), (A86) GP1070: (A27), (A33), (A36), (A72)
 GP1080: (A72), (A83) GP3074: (A27), (A83) GP3980: (A22), (A25), (A27), (A36), (A83), (A86)
 GP4002: (A21), (A22), (A25), (A26), (A27), (A33), (A36), (A72), (A83), (A86)
 GP4210: (A22), (A27), (A33), (A83), (A86) GP4701: (A27), (A33), (A72), (A83), (A86)
 GP4709: (A27) GP4853: (A27) GP55653: (A72)

Minimum quantity order from CEL:

Stock item one case, Non-stock item 120 pieces. No broken carton.

CODE	SIZE	CASE PACK
Versa Trays – Café Trays		
GP55653	40 x 27 cm	12
GP55702	26 x 20	12
GP55703	29 x 21	12

Only available from Cambro European Logistics (CEL), Germany and Cambro Özay Turkey.

CODE	SIZE	CASE PACK
Versa Trays – Space Saver Trays		
GP4210 – Trapezoid	48 x 34 cm	12
GP4410 – Trapezoid	32,5 x 42,5	12
GP4853	42,4 x 32,5	12



Hexagonal table
Lateral side:
70 cm GP4210



Square table
80 x 80 cm
GP4210



Round table
Diam. 135 cm
GP4853



Square Table
95 x 95 cm
GP4853

Versa Trays – Flat Edge Shape



Versa Trays – Café Trays



Versa Trays – Space Saver Trays



Tray Colors:

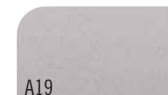

A19
Pebbled Grey

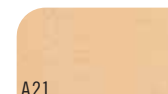

A21
Speckled Mocha



A22
Sahara

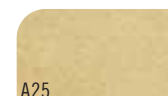

A25
Magic Yellow

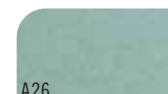

A26
Magic Mint

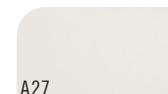

A27
Light Grey

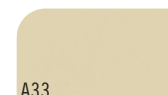

A33
Pearl White

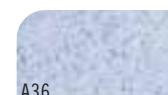

A36
Speckled Blue



A72
Charcoal*



A83
Granite



A86
Terrazzo

Polyester Versa Trays VT/GP are not recommended for use in heated meal delivery carts. Please contact Cambro Customer Service or Presswerk Köngen GmbH, with any questions related to proper usage or any special application. Cambro will provide you with clear instructions on correct usage of our trays to ensure you get the maximum life out of our products.

*Charcoal color A72 will show scratches if not handled properly.

POLYESTER VERSA LITE TRAYS WITH SMOOTH SURFACE

SPECIFICATIONS

Material	SMC – standard performance fiberglass reinforced polyester
Surface Characteristic	Smooth
Performance	Excellent
Stacking Lugs	Yes
Dishwasher Safe	Yes – Normal
Chemical Resistance	Good
Drying Test	Excellent
Shock Resistance	Good
Break Resistance	Good
Scratch Resistance	Good
Stain Resistance	Good
Heat Resistance*	-40° to +130°C‡



‡Not for use in heated carts.
Personalization, see page 197.
*Personalization Heat Resistance: 90°C.

RECOMMENDED USE

Moderate Traffic / Economic Priority

- Schools
- Universities
- Canteens / Cafeterias / Self-Serve
- Military
- Hotel Room Service



High Profile Shape Low Profile Shape

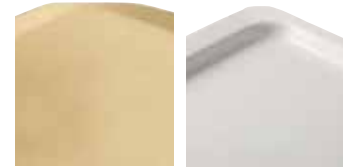

Low Profile Design Shape Flat Edge Shape



Low Profile Flat Edge Shape

Only available from Cambro European Logistics (CEL), Germany and Cambro Özyay Turkey.

CODE	SIZE
Versa Lite Trays – Flat Edge Shape	
GL0540†	46 x 34,4 cm
GL1070†	32,5 x 26,5
GL1080†	37 x 26,5
GL3074	45 x 32
GL3980†	53 x 37
GL4002†	53 x 32,5
GL4060	40 x 60
GL4701	42,5 x 32,5
GL4709	46 x 32,5

Case Pack: 12

†Designed with reinforced corners for automatic off-stacking onto conveyor belt dishwashers.

Versa Lite Trays – Flat Edge Shape



GL4002

CODE	SIZE
Versa Lite Trays – Space Saver Trays	
GL4210 – Trapezoid	48 x 34 cm

Case Pack: 12

Versa Lite Trays – Space Saver Trays



Hexagonal table
Lateral side:
70 cm GL4210



Square table
80 x 80 cm
GL4210

POLYESTER VERSA LITE TRAYS WITH SMOOTH SURFACE

CODE	SIZE
Versa Lite Trays – High Profile Shape	
VL1014	27 x 35 cm
VL1216	30,5 x 41,5
VL3343	33 x 43
VL1418	35,5 x 45,7

Case Pack: 12

Versa Lite Trays – High Profile Shape



VL1418

CODE	SIZE
Versa Lite Trays – Low Profile Flat Edge Shape	
GL220P	32,5 x 53 cm
GL210P	37 x 53

Case Pack: 12

Versa Lite Trays – Low Profile Flat Edge Shape



GL210P

GL220P

Only available from Cambro European Logistics (CEL), Germany and Cambro Özay Turkey.

Tray Colors:

A08
Speckled Sand

A20
Speckled Smoke

A21
Speckled Mocha

A22
Sahara

A27
Light Grey

A33
Pearl White

A83
Granite

A86
Terrazzo

CODE	SIZE
Versa Lite Trays – Low Profile Shape	
VL2632	32,5 x 26,5 cm
VL3253	32,5 x 53
VL3753	37 x 53

Case Pack: 12

Versa Lite Trays – Low Profile Shape



VL3753

Versa Lite Century Trays – Low Profile Design Shape

CODE	SIZE
Versa Lite Century™ Trays – Low Profile Design Shape	
VL3646C	35,5 x 45,7 cm
VL3343C	33 x 43

Case Pack: 12



Innovative low profile and low corner design increases space utilization of tray surface and customer comfort while eating.



VL3646C

CENTURY FUN TRAYS – CREATE A VIBRANT TABLE TOP WITH COLOURFUL TRAYS

SPECIFICATIONS

	Versa Tray	Versa Lite Tray
Material	SMC – high performance fiberglass	SMC – standard performance reinforced polyester fiberglass reinforced polyester
Surface Characteristic	Smooth	Smooth
Performance	Excellent	Excellent
Stacking Lugs	Yes	Yes
Dishwasher Safe	Yes – Extensive	Yes – Normal
Chemical Resistance	Excellent	Good
Drying Test	Excellent	Excellent
Shock Resistance	Excellent	Good
Break Resistance	Excellent	Good
Scratch Resistance	Excellent	Good
Stain Resistance	Excellent	Good
Heat Resistance*	-40° to +90°C‡	-40° to +90°C‡

‡Not for use in heated carts.
Personalization, see page 197.

*Personalization Heat Resistance: 90°C.



RECOMMENDED USE

High Traffic / Frequent Use

- Hospitals
- Schools
- Universities
- Canteens / Cafeterias / Self-Serve
- Military



VT3646C

Reinforced polyester corners provide superior corner and edge protection against impact.

Personalization

Possibility to personalize to any PMS colors of your choice.

Minimum quantity: 120 pieces.

Please refer to personalization procedure and color availability in the Personalization section.

For assistance please contact your Cambro representative.

Stacking lugs keep trays stacked securely in place and ensure proper air flow.

Innovative low profile and low corner design increases space utilization of tray surface and customer comfort while eating.

Only available from Cambro European Logistics (CEL), Germany and Cambro Özay Turkey.

Century Fun Trays are made for intensive use. Scratch, stain, chemical and break-resistant, Century Fun trays are available in 5 contemporary colours on a pure white tray. Match the tray colour to your décor (dishes, furniture, walls, etc.).

Sage on White Tray (F01)

Raspberry on White Tray (F02)

Grape on White Tray (F03)

Pearl Grey on White Tray (F04)

Dark Peach on White Tray (F05)

CODE	DIMENSIONS	CASE PACK
Versa Trays		
VT1418	35,5 x 45,7 cm	12
VT3646C	35,5 x 45,7	12
Versa Lite Trays		
VL1418	35,5 x 45,7	12
VL3646C	35,5 x 45,7	12

POLYESTER NON-SLIP VERSA LITE TRAYS

SPECIFICATIONS

Material	SMC – standard performance fiberglass reinforced polyester
Surface Characteristic	Non-Slip
Performance	Excellent
Stacking Lugs	Yes
Dishwasher Safe	Yes – Normal
Chemical Resistance	Good
Drying Test	Excellent
Shock Resistance	Good
Break Resistance	Good
Scratch Resistance	Good
Stain Resistance	Good
Heat Resistance*	-40° to +80°C‡



PRORATED

‡ Not for use in heated carts.
 Personalization: Contact your Cambro representative for pricing.
 *Personalization Heat Resistance: 90°C.



CODE	SIZE
Versa Lite Trays – High Profile Shape	
VL1418NS	35,5 x 45,7 cm
VL3343NS	33 x 43
Versa Lite Century™ Trays – Low Profile Design Shape	
VL3646CNS	35,5 x 45,7
VL3343CNS	33 x 43
Versa Lite Trays – Flat Edge Shape	
GL3980NS*	53 x 37
GL4002NS*	53 x 32,5

Case Pack: 12.
 *Designed with reinforced corners for automatic off-stacking onto conveyor belt dishwashers.

RECOMMENDED USE

- Intensive Use / Economic Priority**
- Hospitals
 - Schools
 - Universities
 - Canteens / Cafeterias / Self-Serve
 - Military
 - Catering / Cruise Ships
 - Hotels / Room Service

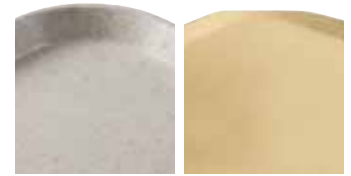

High Profile Shape Low Profile Design Shape



Flat Edge Shape



Reinforced polyester corners provide superior corner and edge protection against impact.



Stacking lugs keep trays stacked securely in place and ensure proper air flow.



Versa Lite Century Trays have low edges and ergonomic corners that enhance comfort.



Non-Slip Trays grip firmly providing safer meal delivery service.

Only available from Cambro European Logistics (CEL), Germany and Cambro Özyay Turkey.

Tray Colors:

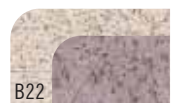

B22 Sahara on Sahara Tray



B14 Titan on Speckled Smoke Tray

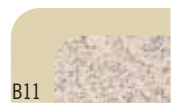

B11 Sahara on Pearl White Tray



B99 Pebbled Black on Light Grey Tray

POLYESTER VERSA LITE TRAYS WITH NON-SLIP RUBBER SURFACE

SPECIFICATIONS

Material	SMC – standard performance fiberglass reinforced polyester + non-slip rubber
Surface Characteristic	Non-Slip Rubber
Performance	Excellent
Stacking Lugs	Yes
Dishwasher Safe	Yes – Normal
Chemical Resistance	Good
Drying Test	Excellent
Shock Resistance	Good
Break Resistance	Good
Scratch Resistance	Good
Stain Resistance	Good
Heat Resistance	-40° to +100°C‡

RECOMMENDED USE

Moderate Traffic / Economic Priority

- Banquet Service
- Restaurant / Cafes
- Bars / Clubs / Pubs
- Catering
- Brasseries

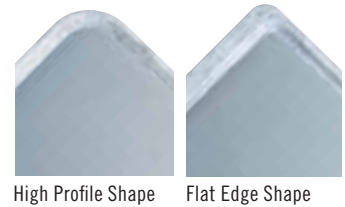

High Profile Shape Flat Edge Shape

Only available from Cambro European Logistics (CEL), Germany and Cambro Özy Turkey.



‡ Not for use in heated carts.



CODE	DIA / SIZE	CASE PACK
Versa Lite Trays – High Profile Shape		
VL1418RNS	35,5 x 45,7 cm	12
Versa Lite Trays – Flat Edge Shape		
GL1070RNS*	32,5 x 26,5	12
GL4002RNS*	53 x 32,5	12
GL3980RNS*	53 x 37	12
Versa Lite Tray – Cafe Trays		
VL2129RNS	21 x 29	12
VL3200RNS	ø 32	12
VL3600RNS	ø 36	12



Patterns and Tray Base Colors:



CAMTRAYS® FIBERGLASS TRAYS WITH SMOOTH SURFACE

SPECIFICATIONS

Material	Fiberglass layers + polyester resin
Surface Characteristic	Smooth
Performance	Excellent
Stacking Lugs	Yes
Dishwasher Safe	Yes – Extensive
Chemical Resistance	Good
Drying Test	Excellent
Shock Resistance	Excellent
Break Resistance	Excellent
Scratch Resistance	Excellent
Stain Resistance	Excellent
Heat Resistance	-10° to +100°C‡

‡ Not for use in heated carts.
Personalization, see page 197.

RECOMMENDED USE

High Traffic / Frequent Use

- Hospitals
- Schools
- Universities
- Canteens / Cafeterias / Self-Serve
- Military
- Hotel Room Service

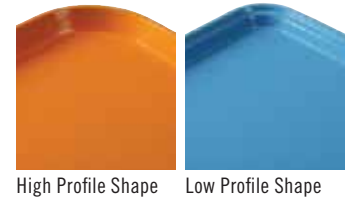

High Profile Shape

Low Profile Shape

†Available in Group I colors and patterns and Group III patterns.

ΔAvailable in Group I colors and patterns except Doily.

*Special order item not carried in stock – non-returnable.



CODE	SIZE	CASE PACK
Rectangular – High Profile Shape		
810†	20,5 x 25 cm	12
915†	22 x 38	12
926*†	22,5 x 65 x 2,5	12
1014†	27 x 35	12
1015*Δ	26 x 38	24
1116*Δ	27,5 x 40,5	24
1216†	30,5 x 41,5	12
1313†	33 x 33	12
1318*†	32 x 45 x 3	12
1418†	35,5 x 45,7	12
1520†	38 x 51,5	12
1622†	40,5 x 56	12
16225*†	42 x 57	12
1826†	45,5 x 65,5	6
Rectangular – Low Profile Shape		
46†	11 x 15	12
57*†	12,5 x 18	12
2025*†	53 x 65	6



CAMTRAYS® FIBERGLASS TRAYS WITH SMOOTH SURFACE

SPECIFICATIONS

Material	Fiberglass Layers + Polyester Resin
Surface Characteristic	Smooth
Performance	Excellent
Stacking Lugs	Yes
Dishwasher Safe	Yes – Extensive
Chemical Resistance	Good
Drying Test	Excellent
Shock Resistance	Excellent
Break Resistance	Excellent
Scratch Resistance	Excellent
Stain Resistance	Excellent
Heat Resistance	-10° to +100°C‡

‡ Not for use in heated carts.

RECOMMENDED USE

High Traffic / Frequent Use

- Hospitals
- Schools
- Universities
- Canteens / Cafeterias / Self-Serve
- Military
- Hotel Room Service

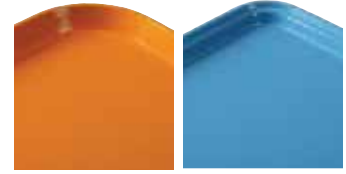

High Profile Shape Low Profile Shape

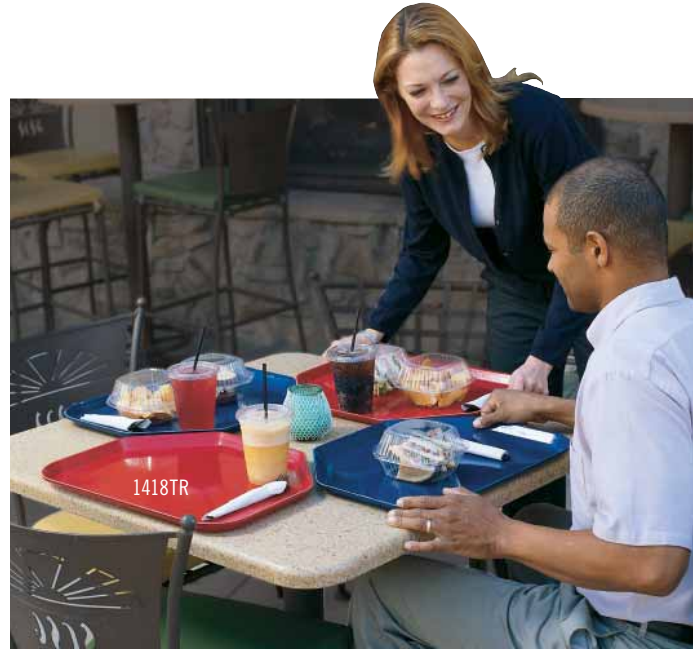
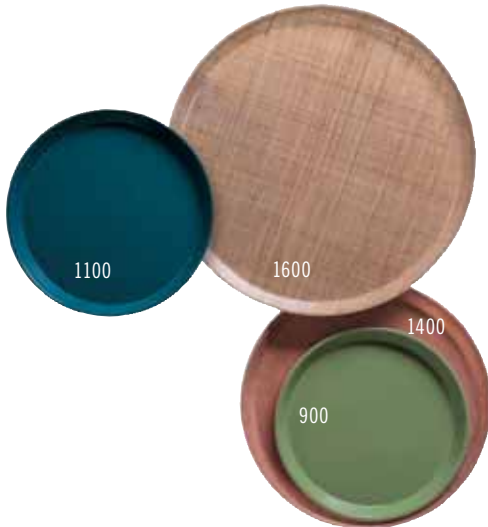

CODE	DIA / SIZE	CASE PACK
Trapezoid – High Profile Shape		
1418TR*†	35,5 x 45,7 cm	12
1422TR*†	35,5 x 56	12
Trapezoid – Low Profile Shape		
1520TR*†	37 x 49,5	12
Oval – Low Profile Shape		
2500*Δ	49 x 61	6
2700*Δ	56 x 68,5	6
Round – High Profile Shape		
900*Δ	ø 23	12
1000*Δ	ø 25,5	12
1100Δ	ø 28	12
1200*Δ	ø 30,5	12
1300*Δ	ø 33	12
1400Δ	ø 35,5	12
1600Δ	ø 40,5	12
Round – Low Profile Shape		
1550*Δ	ø 40,5	12
1950*Δ	ø 49,5	12

†Available in Group I colors and patterns and Group III patterns.

ΔAvailable in Group I colors and patterns except Doily.

*Special order item not carried in stock – non-returnable.



Personalization, see page 197.

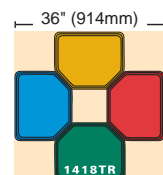
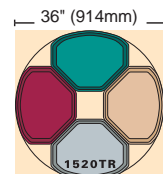
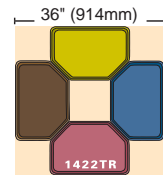

CAMTRAYS® FIBERGLASS TRAYS WITH SMOOTH SURFACE

SPECIFICATIONS

Material	Fiberglass Layers + Polyester Resin
Surface Characteristic	Smooth
Performance	Excellent
Stacking Lugs	Yes
Dishwasher Safe	Yes – Extensive
Chemical Resistance	Good
Drying Test	Excellent
Shock Resistance	Excellent
Break Resistance	Excellent
Scratch Resistance	Excellent
Stain Resistance	Excellent
Heat Resistance	-10° to +100°C‡

* Special order item not carried in stock – non-returnable.

❖ Available in Group I colors only.

1418H and 1520H available in Group I colors only and covered by 2 Year prorated warranty against manufacturer's defects.

NSF listed for non-direct food contact only.



‡ Not for use in heated carts.

Personalization, see page 197.

1418H and 1520H available in four color printing process only. Please refer to Fiberglass Tray Personalization section for details.

RECOMMENDED USE

High Traffic / Frequent Use

- Hospitals
- Schools
- Universities
- Canteens / Cafeterias / Self-Serve
- Military
- Hotel Room Service

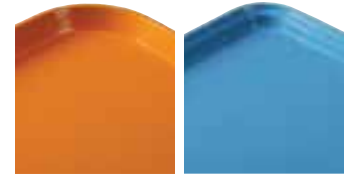

High Profile Shape Low Profile Shape

STOCK PRODUCTS & COLORS AVAILABLE IN OUR EUROPEAN WAREHOUSE

1418H: (110), (199), (538)

3242: (110)

3253: (110), (148)



New!



1418H

CODE	SIZE	CASE PACK
Metric Rectangular – High Profile Shape		
1313	33 x 33 cm	12
3242	31,9 x 41,9	12
3853*	37,5 x 53	12
Metric Rectangular – Low Profile Shape		
2632*	26,5 x 32,5	12
3046*	30 x 46	12
3253*	32,5 x 53	12
3343	33 x 43	12
3753*	37 x 53	12
Camtray with Handles		
1418H* ❖ New!	36 x 46	12
1520H* ❖ New!	38 x 51,5	12



CAMTRAY® GROUP I COLORS

Colors listed alphabetically. See numerical reference on following page.



123
Amazon Blue



101
Antique Parchment



513
Bay Leaf Brown



110
Black



409
Blush



116
Brazil Brown



522
Burgundy Wine



521
Cambro Red



537
Cameo Yellow



505
Cherry Red



220
Citrus Orange



538
Cottage White



117
Dark Peach



104
Desert Tan



514
Earthen Gold



221
Ever Red



551
Grape



105
Horizon Blue



429
Key Lime



536
Lemon Chiffon



106
Light Peach



113
Lime-ade



504
Mustard



428
Olive Green



222
Orange Pizazz



107
Pearl Grey



410
Raspberry Cream



501
Real Rust



518
Robin Egg Blue



119
Sherwood Green



510
Signal Red



177
Sky Blue



401
Slate Blue



508
Suede Brown



199
Taupe



414
Teal



171
Tuscan Gold



148
White

Due to the catalog printing process, the colors & patterns shown may not be exact.
Contact Cambro or a Cambro representative for a color chip.

CAMTRAY® GROUP I PATTERNS

Galaxy

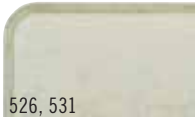

526, 531
Antique Parchment
(526 Gold), (531 Silver)

Swirl



270
Black & Gold **NR**



277
Grey **NR**

Doily



241
Antique Parchment **NR**

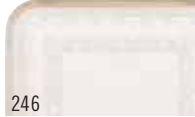

246
Light Peach **NR**

Decorator



203
Grass Mat **NR**

Abstract



214
Tan **NR**



215
Grey **NR**

NR Trays are non-returnable.



CAMTRAY GROUP III – WOOD

Wood



308
Burma Teak **NR**



304
Country Oak **NR**



301
Dark Basketweave **NR**



309
Java Teak **NR**



329
Toffee **NR**



302
Light Basketweave **NR**



303
Light Butcher Block **NR**



307
Light Elm **NR**



204
Rattan **NR**

NR Trays are non-returnable.

Linen

CAMTRAY GROUP I COLORS – NUMERICAL REFERENCE BY COLOR CODE

Antique Parchment (101),
Desert Tan (104), Horizon Blue (105),
Light Peach (106), Pearl Gray (107),
Black (110), Lime-ade (113),
Brazil Brown (116), Dark Peach (117),
Sherwood Green (119),
Amazon Blue (123), White (148),

Tuscan Gold (171), Sky Blue (177),
Taupe (199), Citrus Orange (220),
Ever Red (221) Orange Pizazz (222),
Slate Blue (401), Blush (409),
Raspberry Cream (410),
Teal (414), Olive Green (428),
Key Lime (429), Real Rust (501),

Mustard (504), Cherry Red (505),
Suede Brown (508), Signal Red (510),
Bayleaf Brown (513),
Earthen Gold (514),
Robin Egg Blue (518),
Cambro Red (521),
Burgundy Wine (522),

Lemon Chiffon (536),
Cameo Yellow (537),
Cottage White (538), Grape (551).

**Due to the catalog printing process, the colors & patterns shown may not be exact.
Contact Cambro or a Cambro representative for a color chip.**

NON-SLIP VERSA CAMTRAYS®

- Non-Slip Camtrays provide a better grip for safer meal delivery.
- Stacking lugs keep trays stacked securely in place and ensure proper air flow.
- Temperature range resistance from -40° to 80°C.‡

Colors: Black with Pebbled Black (382), Pearl Gray with Titan (381), Ivory with Sahara (380).



PRORATED

Personalization: Contact your Cambro representative for pricing.

‡ Not recommended for heated carts.



High Profile Shape Flat Edge Shape



CODE	DESCRIPTION	SIZE
1418VC	Non-Slip Versa Camtray	35,5 x 45,7 cm
1520VC	Non-Slip Versa Camtray	38 x 51

Case Pack: 12

Black with Pebbled Black (382)

Pearl Gray with Titan (381)

Ivory with Sahara (380)

NON-SLIP VERSA CAMTRAYS WITH HANDLES

- Contoured handles allow for safe and elegant meal delivery.
- Non-Slip surface firmly grips table top items.
- Stacking lugs keep trays stacked securely in place and ensure proper air flow.
- Temperature range resistance from -40° to 80°C.‡

Colors: Black with Pebbled Black (382), Pearl Gray with Titan (381), Ivory with Sahara (380).

Non-Slip Versa Camtrays with Handles are covered by U.S. Patent D 683,191 S.



PRORATED

Personalization: Contact your Cambro representative for pricing.

‡ Not recommended for heated carts.



CODE	DESCRIPTION	SIZE
1418VCH new!	Non-Slip Versa Camtray with Handles	36 x 46 cm
1520VCRST	Non-Slip Versa Camtray with Handles	38 x 51

Case Pack: 12

DIETARY TRAYS

SPECIFICATIONS

Material	Fiberglass layers + polyester resin
Surface Characteristic	Smooth
Performance	Excellent
Stacking Lugs	Yes
Dishwasher Safe	Yes – Extensive
Chemical Resistance	Good
Drying Test	Excellent
Shock Resistance	Excellent
Break Resistance	Good
Scratch Resistance	Good
Stain Resistance	Excellent
Heat Resistance	-10° to +100°C‡

‡ Not for use in heated carts.

RECOMMENDED USE

High Traffic / Frequent Use
– Hospitals
– Schools
– Universities
– Canteens / Cafeterias / Self-Serve
– Military
– Hotel Room Service

Available in Group I colors and patterns and Group III Patterns.

* Special order item not carried in stock – non-returnable.



CAMLITE® TRAYS

SPECIFICATIONS

Material	Fiberglass layers + polyester resin
Surface Characteristic	Smooth
Performance	Excellent
Stacking Lugs	Yes
Dishwasher Safe	Yes – Extensive
Chemical Resistance	Good
Drying Test	Excellent
Shock Resistance	Excellent
Break Resistance	Good
Scratch Resistance	Good
Stain Resistance	Excellent
Heat Resistance	-10° to +100°C‡

‡ Not for use in heated carts.

RECOMMENDED USE

High Traffic / Frequent Use
– Hospitals
– Schools
– Universities
– Canteens / Cafeterias / Self-Serve
– Military
– Hotel Room Service

Colors: Rose Red (163), Yellow (145), Green (162), Blue (142), Tan (161), Steel White (676), Steel Red (675), Steel Blue (674), Black (110).

12 dozen minimum order required for any special color orders.



Low Profile Shape



CODE	SIZE	CASE PACK
Dietary Trays – Low Profile Shape		
1216D*	30,5 x 41,5 cm	12
1219D*	30,5 x 48,3	12
1220D*	30,5 x 51	12
1222D*	30,5 x 56	12
1418D*	35,5 x 46	12
1520D*	38 x 51,3	12

CODE	SIZE	CASE PACK
Rectangular Camlite Trays – High Profile Shape		
1014CL	27 x 35 cm	12
1216CL	30,5 x 41,5	12
1418CL	35,5 x 45,7	12
1520CL	38 x 51,5	12
1826CL	45,5 x 65,5	12
Rectangular Camlite Trays – Low Profile Shape		
3253CL	32,5 x 53	12

POLYCARBONATE TRAYS

SPECIFICATIONS

Material	Polycarbonate
Surface Characteristic	Textured
Performance	Excellent
Stacking Lugs	Yes
Dishwasher Safe	Yes – Extensive
Chemical Resistance	Good
Drying Test	Excellent
Shock Resistance	Excellent
Break Resistance	Excellent
Scratch Resistance	Very Good
Stain Resistance	Very Good
Heat Resistance	-40° to +99°C‡



‡ Not for use in heated carts.

POLYCARBONATE TRAYS WITH NON-SLIP SURFACE

SPECIFICATIONS

Material	Polycarbonate
Surface Characteristic	Non-Slip
Performance	Excellent
Stacking Lugs	Yes
Dishwasher Safe	Yes – Extensive
Chemical Resistance	Good
Drying Test	Excellent
Shock Resistance	Excellent
Break Resistance	Excellent
Scratch Resistance	Good
Stain Resistance	Good
Heat Resistance	-40° to +82°C‡



‡ Not for use in heated carts.

RECOMMENDED USE

Moderate Traffic / Economic Priority

- Schools
- Universities
- Canteens / Cafeterias / Self-Serve
- Military
- Quick Serve Restaurants
- Food Courts / Snack Shops

Colors: Blue (168), Beige (133).

NSF listed for non-direct food contact only.



High Profile Shape

RECOMMENDED USE

Moderate Traffic / Economic Priority

- Schools / Universities
- Canteens / Cafeterias / Self-Serve
- Military
- Quick Serve Restaurants
- Food Courts / Snack Shops
- Restaurants / Cafes
- Brasseries
- Hotels / Room Service
- Hospitals

Colors: Black (110), Dark Cranberry (488).

NSF listed for non-direct food contact only.

Black (110)

Dark Cranberry (488)



CODE	SIZE	CASE PACK
Rectangular – High Profile Shape		
1418CW	35,5 x 46 cm	12
1520CW	38 x 51	12
Trapezoid – High Profile Shape		
1418TRCW	35,5 x 46	12

CODE	SIZE	CASE PACK
Rectangular – High Profile Shape		
1418CWNS	35,5 x 46 cm	12
1520CWNS	38 x 51	12

CAMTREAD® FIBERGLASS TRAYS WITH NON-SLIP RUBBER SURFACE

SPECIFICATIONS

Material	Fiberglass layers + polyester resin + non-slip rubber surface molded from edge-to-edge
Surface Characteristic	Non-Slip Rubber
Performance	Excellent
Stacking Lugs	Yes
Dishwasher Safe	Yes – Extensive
Chemical Resistance	Good
Drying Test	Excellent
Shock Resistance	Excellent
Break Resistance	Good
Scratch Resistance	Excellent
Stain Resistance	Good
Heat Resistance	-10° to +100°C‡

‡ Not for use in heated carts.

RECOMMENDED USE

High Traffic / Frequent Use

- Banquet Service
- Restaurants / Cafes
- Bars / Clubs / Pubs
- Catering
- Brasseries

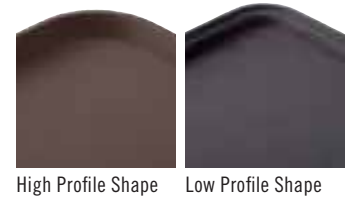

High Profile Shape Low Profile Shape



Low Profile Shape Oval



CODE	DIA / SIZE	CASE PACK
Round – High Profile Shape		
900CT*	ø 23 cm	12
1100CT	ø 28	12
1400CT	ø 35,5	12
1600CT	ø 40,5	12
1800CT	ø 45	6
Round – Low Profile Shape		
1550CT*	ø 40,5	12
1950CT*	ø 49,5	12
Oval – Low Profile Shape		
2500CT	49 x 59	6
2700CT	56 x 68,5	6
2900CT	73,5 x 60	6
Rectangular – High Profile Shape		
1014CT*	27 x 35	12
1216CT	30,5 x 41,5	12
1418CT	36 x 46	12
1520CT*	38 x 51,5	12
1622CT*	40,5 x 56	12
1826CT	45 x 65	6
Rectangular – Low Profile Shape		
3253CT	32,5 x 53	12

Orders for non-standard Camtread Tray colors will be handled by special quotation only.

* Special order item not carried in stock – non-returnable.

Do not use Camtread Trays in enclosed heated carts.

Personalization see page 198 for size and detail.

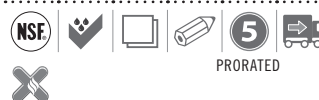

Tray Colors:

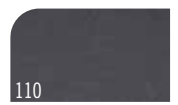

110 Black Satin
138 Tavern Tan

TREADLITE™ TRAYS

SPECIFICATIONS

Material	Fiberglass layers + polyester resin + non-slip rubber surface
Surface Characteristic	Non-Slip rubber surface
Performance	Good
Stacking Lugs	Yes
Dishwasher Safe	Yes – Minimal
Chemical Resistance	Good
Drying Test	Good
Shock Resistance	Good
Break Resistance	Good
Scratch Resistance	Good
Stain Resistance	Good
Heat Resistance	-10° to +80°C‡



‡ Not for use in heated carts.

RECOMMENDED USE

Moderate Traffic / Economic Priority
– Brasseries
– Restaurants / Cafes
– Bars / Clubs / Pubs

POLYTREAD® TRAYS

SPECIFICATIONS

Material	Polypropylene + Non-Slip rubber surface
Surface Characteristic	Non-Slip rubber surface
Performance	Good
Stacking Lugs	Yes
Dishwasher Safe	Yes – Minimal
Chemical Resistance	Good
Drying Test	Good
Shock Resistance	Good
Break Resistance	Good
Scratch Resistance	Good
Stain Resistance	Good
Heat Resistance	-10° to +80°C‡



‡ Not for use in heated carts.

RECOMMENDED USE

Moderate Traffic / Economic Priority
– Brasseries
– Restaurants / Cafes
– Bars / Clubs / Pubs



Tray Colors:



Tray Colors:

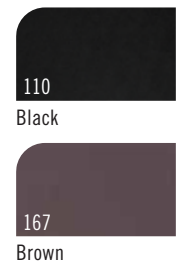

CODE	DIA	CASE PACK
Round – High Profile Shape		
1400TL	ø 35,5 cm	12
1600TL	ø 40,5	12

CODE	DIA / SIZE	CASE PACK
Round – High Profile Shape		
PT1100	ø 28 cm	12
PT1400	ø 35,5	12
PT1600	ø 40,5	12
Rectangular – High Profile Shape		
PT1014	27 x 34,5	24
PT1216	30 x 41,5	24
PT1418	36 x 46	12

BEECHWOOD TRAYS WITH SMOOTH SURFACE

SPECIFICATIONS

Material	Veneer Beechwood
Surface Characteristic	Smooth
Performance	Good
Stacking Lugs	No
Dishwasher Safe	Yes – Normal
Chemical Resistance	Good
Drying Test	Good
Shock Resistance	Good
Break Resistance	Good
Scratch Resistance	Good
Stain Resistance	Good
Heat Resistance	-10° to +100°C‡



‡ Not for use in heated carts.

BEECHWOOD TRAYS WITH NON-SLIP SURFACE

SPECIFICATIONS

Material	Veneer Beechwood
Surface Characteristic	Non-Slip Surface
Performance	Good
Stacking Lugs	No
Dishwasher Safe	Yes – Minimal
Chemical Resistance	Good
Drying Test	Good
Shock Resistance	Good
Break Resistance	Good
Scratch Resistance	Good
Stain Resistance	Good
Heat Resistance	-10° to +100°C‡



‡ Not for use in heated carts.

RECOMMENDED USE

Mild Use / Emphasis on style with limited washing

- Banquet Service
- Restaurants / Cafes
- Catering



Only available from Cambro European Logistics (CEL), Germany and Cambro Özyay Turkey.

RECOMMENDED USE

Mild Use / Emphasis on style with limited washing

- Banquet Service
- Restaurants / Cafes
- Bars / Clubs / Pubs
- Catering
- Brasseries



Tray Color:



Beechwood



Tray Color:



Beechwood

CODE	DIA / SIZE	CASE PACK
Rectangular – 60 Series		
PH556010	45 x 32 cm	12
PH556020	58 x 38	12
PH556030	63 x 40	12
PH556040	70 x 45	12
PH556050	75 x 48	12
Rectangular – 65 Series		
PH556510	27 x 20	12
PH556520	33 x 23	12
Oval		
PH557010	23 x 16	24
PH557020	26 x 20	24
PH557030	29 x 21	24
PH557040	33 x 24	24
Round Beer Tray		
PH558510	ø 32	12
PH558520	ø 36	12
PH558530	ø 42	12

CODE	DIA / SIZE	CASE PACK
Rectangular – 60 Series		
PH556016	45 x 32 cm	12
PH556026	58 x 38	12
PH556036	63 x 40	12
PH556046	70 x 45	12
PH556056	75 x 48	12
Rectangular – 65 Series		
PH556516	27 x 20	12
PH556526	33 x 23	12
Oval		
PH557016	23 x 16	24
PH557026	26 x 20	24
PH557036	29 x 21	24
PH557046	33 x 24	24
Round Beer Tray		
PH558516	ø 32	12
PH558526	ø 36	12
PH558536	ø 42	12

MAHOGANY WOOD TRAYS WITH NON-SLIP SURFACE

SPECIFICATIONS

Material	Mahogany Veneer
Surface Characteristic	Non-Slip Surface
Performance	Good
Stacking Lugs	No
Dishwasher Safe	Yes – Minimal
Chemical Resistance	Good
Drying Test	Good
Shock Resistance	Good
Break Resistance	Good
Scratch Resistance	Good
Stain Resistance	Good
Heat Resistance	-10° to +100°C‡



‡ Not for use in heated carts.

RECOMMENDED USE

Mild Use / Emphasis on style with limited washing

- Banquet Service
- Restaurants / Cafes
- Bars / Clubs / Pubs
- Catering
- Brasseries

Only available from Cambro European Logistics (CEL), Germany and Cambro Özyay Turkey.



CODE	DIA / SIZE	CASE PACK
Rectangular		
MW3245	32 x 45 cm	12
MW3858	37,5 x 57,5	12
MW3646	36 x 46	12
Oval		
MW2129	21 x 29	12
Round Beer Tray		
MW3200	ø 32	12
MW3600	ø 36	12
MW4200	ø 42	12

Tray Color:



CORFU – LAMINATED TRAYS WITH NON-SLIP RUBBER SURFACE

SPECIFICATIONS

Material	Laminate + non-slip rubber surface
Surface Characteristic	Non-Slip rubber surface
Performance	Excellent
Stacking Lugs	No
Dishwasher Safe	Yes – Normal
Chemical Resistance	Excellent
Drying Test	Good
Shock Resistance	Good
Break Resistance	Good
Scratch Resistance	Good
Stain Resistance	Good
Heat Resistance	-10° to +100°C‡



Personalization,
see page 198.

PRORATED

‡ Not for use in heated carts.
Note: All laminated trays must
be dried before stacking.

RECOMMENDED USE

Normal Use / Emphasis on style
with limited washing

- Canteens / Cafeterias / Self-Serve
- Banquet Service
- Restaurants / Cafes
- Bars / Clubs / Pubs
- Catering

Only available from Cambro European Logistics (CEL), Germany and Cambro Özay Turkey.



CODE	DIA / SIZE	CASE PACK
Rectangular		
C02632	26,5 x 32,5 cm	12
C03253	32,5 x 53	12
C03343	33 x 43	12
C03646	36 x 46	12
C03753	37 x 53	12
Round		
C03200	ø 32	12
C03800	ø 38	12
C04300	ø 43	12

Tray Color:

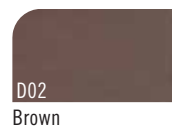

CAPRI – LAMINATED TRAYS WITH SMOOTH SURFACE

SPECIFICATIONS

Material	Laminate
Surface Characteristic	Smooth
Performance	Good
Stacking Lugs	No
Dishwasher Safe	Yes – Normal
Chemical Resistance	Excellent
Drying Test	Good
Shock Resistance	Good
Break Resistance	Good
Scratch Resistance	Good
Stain Resistance	Excellent
Heat Resistance	-10° to +100°C‡

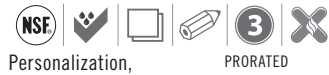

Personalization,
see page 198.

PRORATED

‡ Not for use in heated carts.

Note: All laminated trays must be dried before stacking.

RECOMMENDED USE

Moderate Traffic / Economic Priority

- Canteens / Cafeterias / Self-Serve
- Hotel Room Service
- Restaurants / Cafes
- Bars / Clubs / Pubs
- Catering
- Brasseries

Only available from Cambro European Logistics (CEL), Germany and Cambro Üzay Turkey.

CODE	OUTER DIMENSIONS	INNER DIMENSIONS
Rectangular with Handles		
1525RST	40 x 64 cm	35,6 x 53,3 cm
Case Pack: 12		

Capri – Rectangular with Handles



Brushed Steel
(E85)

Venge
(E84)

Walnut
(E76)



CAPRI – LAMINATED TRAYS WITH SMOOTH SURFACE

CODE	DIMENSIONS	CASE PACK
Rectangular		
CA2028	20 x 28 cm	24
CA2632	26,5 x 32,5	24
CA2738	27 x 38	24
CA2836	28 x 36	24
CA3244	32 x 44	24
CA3253	32,5 x 53	24
CA3343	33 x 43	24
CA3446	34 x 46	24
CA3646	36 x 46	24
CA3748	37 x 48	24
CA3753	37 x 53	24
CA3952	39 x 52	24
CA4361	43 x 61	12

Capri – Rectangular



Only available from Cambro European Logistics (CEL), Germany and Cambro Üzay Turkey.

CODE	DIA	CASE PACK
Round		
CA1300	ø 13 cm	24
CA3200	ø 32	24
CA3800	ø 38	24
CA4300	ø 43	24

Capri – Round



Tray Colors:

E73
Mahogany

E75
Birch

E76
Walnut

E77
Teak

E78
White

E79
Black

E80
Beige

E81
Grey

E82
Charcoal Granite



Tray Pattern:

Thank You (E01)
Available in CA1300 only.

CODE	SIZE	CASE PACK
Trapezoid		
CA3247TR	32 x 47 cm	24

Capri – Trapezoid



CODE	SIZE	CASE PACK
Oval		
CA1623	16 x 23 cm	24
CA2026	20 x 26,5	24
CA2129	21 x 29	24

Capri – Oval



MYKONOS – LAMINATED TRAYS WITH NON-SLIP SURFACE

SPECIFICATIONS

Material	Laminate + Non-Slip Surface
Surface Characteristics	Non-Slip Surface
Performance	Good
Stacking Lugs	No
Dishwasher Safe	Yes – Minimal
Chemical Resistance	Good
Drying Test	Good
Shock Resistance	Good
Break Resistance	Good
Scratch Resistance	Good
Stain Resistance	Good*
Heat Resistance	-10° to +100°C‡



Personalization, see page 198.

PRORATED

‡ Not for use in heated carts.

Note: All laminated trays must be dried before stacking.

* Limited stain resistance for Birch (E75).

RECOMMENDED USE

Moderate Use / Emphasis on Style with Limited Washing

- Banquet Services
- Restaurants / Cafes
- Bars / Clubs / Pubs
- Catering



Only available from Cambro European Logistics (CEL), Germany and Cambro Üzay Turkey.



Tray Colors:

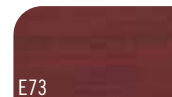

E73
Mahogany

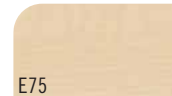

E75
*Birch



E76
Walnut



E77
Teak



E79
Black



E82
Charcoal Granite

CODE	DIA / SIZE	CASE PACK
Rectangular		
MY2632	26,5 x 32,5 cm	24
MY2738	27 x 38	24
MY3244	32 x 44	24
MY3253	32,5 x 53	24
MY3343	33 x 43	24
MY3446	34 x 46	24
MY3646	36 x 46	24
MY3753	37x 53	24
MY3952	39 x 52	24
MY4361	43 x 61	12
Oval		
MY2026	20 x 26,5	24
MY2129	21 x 29	24
Round		
MY3200	ø 32	24
MY3800	ø 38	24
MY4300	ø 43	24

MADEIRA – LAMINATED TRAYS WITH TEXTURED WOOD SURFACE

SPECIFICATIONS

Material	Laminate
Surface Characteristics	Textured – Top and Bottom
Performance	Good
Stacking Lugs	No
Dishwasher Safe	Yes – Normal
Chemical Resistance	Excellent
Drying Test	Good
Shock Resistance	Good
Break Resistance	Good
Scratch Resistance	Good
Stain Resistance	Excellent
Heat Resistance	-10° to +100°C‡



Personalization, see page 198.

PRORATED

‡ Not for use in heated carts.

Note: All laminated trays must be dried before stacking.

RECOMMENDED USE

Moderate Traffic / Economic Priority

- Canteens / Cafeterias / Self-Serve
- Hotel Room Service
- Restaurants / Cafes
- Bars / Clubs / Pubs

Only available from Cambro European Logistics (CEL), Germany and Cambro Özay Turkey.



MA3646

MA2435

MA3652TR

MA3142H

Tray Colors:

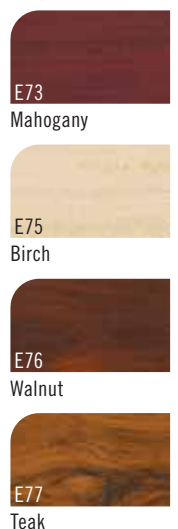

CODE	DIA / SIZE	CASE PACK
Rectangular		
MA2435	24 x 35 cm	24
MA3343	33 x 43	24
MA3646	36 x 46	24
MA4361	43 x 61	12
Rectangular with handle		
MA3142H	31 x 42	24
Trapezoid		
MA3652TR	36 x 52	24
Round		
MA3200	ø 32	24
MA3800	ø 38	24
MA4300	ø 43	24

FAST FOOD TRAYS

SPECIFICATIONS

Material	Polypropylene
Surface Characteristic	Textured
Performance	Good
Stacking Lugs	Yes
Dishwasher Safe	Yes-Minimal**
Chemical Resistance	Excellent
Drying Test	Good
Shock Resistance	Good
Break Resistance	Good
Scratch Resistance	Good
Stain Resistance	Good
Heat Resistance	-10° to +80°C‡

* Available in the following colors:

Black (110), Sherwood Green (119),
Orange (166), Brown (167),
Cranberry (416).

‡ Not for use in heated carts.

** Wash once per day for 60 seconds at a
maximum temperature of 80°C.

* Personalization not available. Product
non-returnable.



1418FF

RECOMMENDED USE

Moderate Traffic / Economic Priority

- Quick Serve Restaurants
- Food Courts / Snack Shops



High Profile Shape

High Profile Shape
with handles

STOCK PRODUCTS & COLORS AVAILABLE IN OUR EUROPEAN WAREHOUSES

1014FF, 1216FF: (110), (119), (163),
(167), (168), (186)

1418FF: (107), (110), (119), (163),
(167), (168), (186)

1217FFH: (110), (119), (166), (167), (416)



1217FFH

Available Colors:



CODE	SIZE	CASE PACK
Rectangular – High Profile Shape		
1014FF	26,5 x 34,5 cm	24
1216FF	30 x 41	24
1418FF	35 x 45	12
Rectangular – High Profile Shape with Handles		
1217FFH*	30 x 43	24



Personalization,
see page 184.

COMPARTMENT TRAYS

SPECIFICATIONS

Code	10146CW	BCT1014	PS1014
Material	Polycarbonate	ABS	Co-Polymer
Surface Characteristic	Textured	Textured	Textured
Performance	Excellent	Excellent	Excellent
Stacking Lugs	Yes	Yes	Yes
Dishwasher Safe	Yes – Extensive	Yes – Extensive	Yes – Minimal
Chemical Resistance	Good	Excellent	Excellent
Drying Test	Excellent	Excellent	Excellent
Shock Resistance	Excellent	Good	Good
Break Resistance	Excellent	Good	Excellent
Scratch Resistance	Very Good	Very Good	Very Good
Stain Resistance	Very Good	Very Good	Very Good
Heat Resistance	-40° to +99°C‡	-10° to +82°C‡	-10° to +80°C‡

‡ Not for use in heated carts.

PS1014



150CW, 100CW, 50CW, 45CW, 35CW, 10CW and SRB5CW reusable bowls fit in this tray and can be used to serve cereal, soup & salads.



BCT1014



PS1014 on OETR314 Open End Tray Rack.

CODE	SIZE	CASE PACK
Polycarbonate		
10146CW	25,4 x 36,5 cm	24
ABS		
BCT1014	25,4 x 36,5	24
Co-Polymer		
PS1014	25,4 x 36,5	24



BCT1014, PS1014 & 10146CW

RECOMMENDED USE

Moderate Traffic / Economic Priority

- School
- Universities
- Military

ABS and Co-Polymer trays are not NSF listed.



Polycarbonate

3 PRORATED



119 Sherwood Green



145 Yellow



416 Cranberry



133 Beige



186 Navy Blue



110 Black

ABS

2 PRORATED



119 Sherwood Green



161 Tan



186 Navy Blue



416 Cranberry



145 Yellow



163 Red



414 Teal

Co-Polymer

2 PRORATED



437 Grass Green



161 Tan



414 Teal



145 Yellow

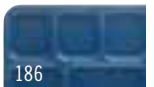

186 Navy Blue



416 Cranberry

COMPARTMENT TRAYS

SPECIFICATIONS

Material	Polycarbonate	Co-Polymer
Surface Characteristic	Textured	Textured
Performance	Excellent	Excellent
Stacking Lugs	Yes	Yes
Dishwasher Safe	Yes – Extensive	Yes – Minimal
Chemical Resistance	Good	Excellent
Drying Test	Excellent	Excellent
Shock Resistance	Excellent	Good
Break Resistance	Excellent	Excellent
Scratch Resistance	Very Good	Very Good
Stain Resistance	Very Good	Very Good
Heat Resistance	-40° to +99°C‡	-10° to +80°C‡

‡ Not for use in heated carts.



915CP



1596CW



915CW & 915CP

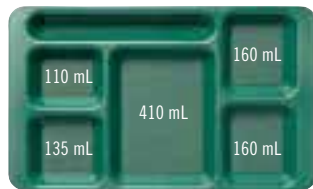

1596CW & 1596CP

CODE	SIZE	CASE PACK
Polycarbonate		
1596CW	22,9 x 38 cm	24
915CW	22,2 x 38	24
Co-Polymer		
1596CP	22,9 x 38	24
915CP	22,2 x 38	24



915CW and 1596CW inside two PR314 Camracks.

RECOMMENDED USE

Moderate Traffic / Economic Priority

- School
- Universities
- Military

100CW, SRB13CW and 50CW bowls fit in round compartment. 10CW and 150CW bowls fit in square compartment. See Dinnerware and Swirl Bowl sections.

ABS and Co-Polymer trays are not NSF listed.

Polycarbonate Trays are NSF Listed
Excluding Color: Translucent Blue (431).



Polycarbonate

3 PRORATED



119
Sherwood Green



404
Red



133
Beige



414
Teal



168
Blue



416
Cranberry



186
Navy Blue



110
Black



431
Translucent Blue

Co-Polymer

2 PRORATED

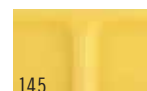

145
Yellow



186
Navy Blue



416
Cranberry

MEAL DELIVERY TRAYS & SEPARATOR® COMPARTMENT TRAYS

Meal Delivery Trays

- Three deep-dish food compartments for large portions.
- Snap-on cover fits securely.
- Textured surface minimizes scratching.

Polycarbonate Colors:
Beige (133), Teal (414).
Lid Color: Clear (135).

Co-Polymer Colors:
Teal (414), Brown (167), Tan (161).
Lid Color: White (148).

Co-Polymer is not NSF Listed.

Not for use in heated carts.



Separator® Compartment Trays

- Six compartment tray designed specifically for in-cell feeding programs.
- Serve both hot and cold food from the same tray.
- Tray with cover separates each compartment to retain food temperature and reduce spills.
- Locking ridges on top of cover and bottom of tray ensure more secure stacking.

Polycarbonate Color: Beige (133).
Lid Color: Clear (135).

Co-Polymer Colors:
Teal (414), Brown (167), Tan (161).
Lid Color: Translucent (190).

Co-Polymer is not NSF Listed.

Not recommended for heated cart.



Polycarbonate

3 PRORATED

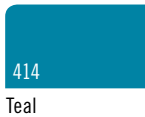

Co-Polymer

2 PRORATED

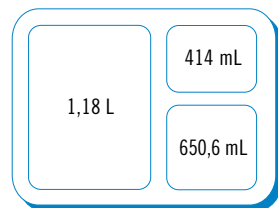
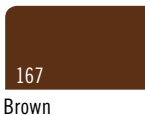

9113CW/9113CP

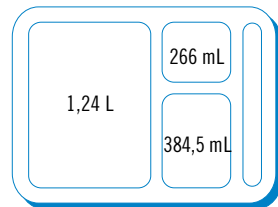

9114CW/9114CP

CODE	DESCRIPTION	DIMENSIONS W x L x D
Polycarbonate		
9113CW	3 Compartments	22,8 x 27,9 x 6,8 cm
9114CW	4 Compartments	22,8 x 27,8 x 6,7
9113CW	Lid fits both trays	22,9 x 28 x 1,4
Co-Polymer		
9113CP	3 Compartments	22,5 x 27,2 x 6,6
9114CP	4 Compartments	22,6 x 27,2 x 6,6
9113CP	Lid fits both trays	22,6 x 27,4 x 1,4

Case Pack: 24



Polycarbonate

3 PRORATED



Co-Polymer

2 PRORATED

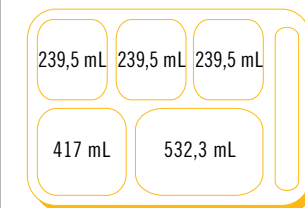
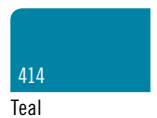
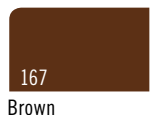

10146DCW/10146DCP

CODE	DESCRIPTION	DIMENSIONS W x L x D
Polycarbonate		
10146DCW	6 Compartments	25,4 x 36,1 x 3,3 cm
10146DCWC	Lid fits 10146DCW	26 x 36,2 x 3,5
Co-Polymer		
10146DCP	6 Compartments	25,4 x 36 x 2,9
10146DCPC	Lid fits 10146DCP	25,6 x 35,6 x 3,6

Case Pack: 24

TRAY ON TRAY MEAL DELIVERY SYSTEM

Base Tray

- Combine hot and cold food portions into a reusable, single service unit.
- Works as a tray or for in-cell feeding with the insert tray.
- Base tray has 5 compartments with 1 compartment for resting the insert tray.

Polycarbonate Color: Beige (133).

Co-Polymer Colors:
Brown (167), Tan (161).

Co-Polymer is not NSF Listed.

Not for use in heated carts.



1411CW



1411CW/1411CP



1411CW base tray with 853FH insert tray

Polycarbonate

3 PRORATED



133
Beige

Co-Polymer

2 PRORATED

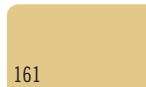

161
Tan



167
Brown

CODE	DESCRIPTION	DIMENSIONS W x L x D
Polycarbonate		
1411CW	Compartments	26,8 x 36,5 x 3,3 cm
Co-Polymer		
1411CP	Compartments	26,8 x 36,5 x 3,3
Case Pack: 24		

Insert Tray

- Eight trays efficiently fit on a standard sheet pan or in an 45,5 x 65,5 cm wire rack.

Polycarbonate Color: Beige (133).
Lid Color: Clear (135).

Co-Polymer Colors:
Brown (167), Tan (161).

Lid Color: Translucent (190).

Heat Resistant Plastic
Tray and Lid Color: Amber (150).

Co-Polymer is not NSF Listed.

Not for use in heated carts.



Polycarbonate

3 PRORATED

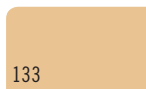

133
Beige

Co-Polymer

2 PRORATED

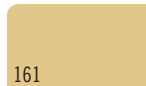

161
Tan

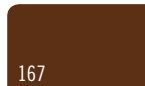

167
Brown

Heat Resistant Plastic

2 PRORATED

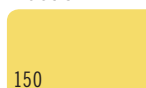

150
Amber



853FCW/853FCP/853FH

CODE	DESCRIPTION	DIMENSIONS W x L x D
Polycarbonate		
853FCW	Compartments	16 x 22,1 x 4,8 cm
853FCWC	Lid for 853FCW	17,1 x 22,4 x 0,6
Co-Polymer		
853FCP	Compartments	16 x 22,1 x 4,8
853FCPC	Lid for 853FCP	17,1 x 22,4 x 0,6
Heat Resistant Plastic		
853FH	Compartments	16 x 22,1 x 4,8
853FHC	Lid for 853FH	17,1 x 22,4 x 0,6
Case Pack: 24		

COMPARTMENT SERVING TRAYS

- For cafeteria-style feeding in high security environments.
- Compartment configurations designed to meet all menu requirements.
- Trapezoid Compartment Trays space saving for self serve correctional facility feeding.

Polycarbonate 6-Compartment Colors: Navy (186), Cranberry (416), Yellow (145), Sherwood Green (119), Beige (133), Black (110).

7 & 5-Compartment Color: Beige (133).
Co-Polymer Colors: Brown (167), Tan (161).

Polycarbonate Compartment NSF Listed Colors: Beige (133), Black (110).

14187TRCW and 14105CP are not NSF Listed.

Trapezoid Compartment Trays are covered by the following U.S. Patent D 508,634.

Polycarbonate  PRORATED

Co-Polymer  PRORATED



10146CW

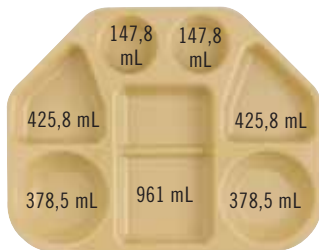

14187TRCW

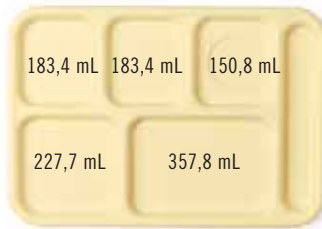

10146CW

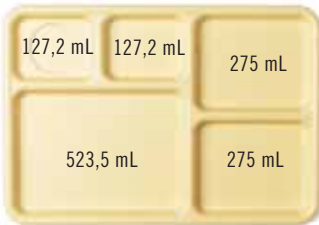

10145CW



14105CW

Also Available in 14105CP

CODE	DESCRIPTION	MENSIONS W x L x D	CASE PACK
Polycarbonate			
14187TRCW	7 compartments, trapezoid	45,6 x 35,4 x 4 cm	12
10146CW	6 compartments	25,4 x 36,8 x 2,4	24
14105CW	5 compartments	27,2 x 35,2 x 2,9	24
10145CW	5 compartments	25,4 x 36,8 x 2,4	24
Co-Polymer			
14105CP	5 compartments	27,2 x 35,2 x 2,9	24

MARKET TRAYS AND PANS

SPECIFICATIONS

Material	Fiberglass layers + polyester resin
Surface Characteristic	Smooth
Performance	Excellent
Stacking Lugs	Yes
Dishwasher Safe	Yes – Extensive
Chemical Resistance	Good
Drying Test	Excellent
Shock Resistance	Excellent
Break Resistance	Good
Scratch Resistance	Good
Stain Resistance	Excellent
Heat Resistance	-10° to +100°C‡

‡ Not for use in heated carts.

RECOMMENDED USE

Moderate Traffic /
Economic Priority
– Deli / Buffet Displays

Colors: Yellow (145)**, Blue (142), Green (140), White (148), Black (110).

* Special order item not carried in stock – non-returnable.

** NSF listed for non-direct food contact only.

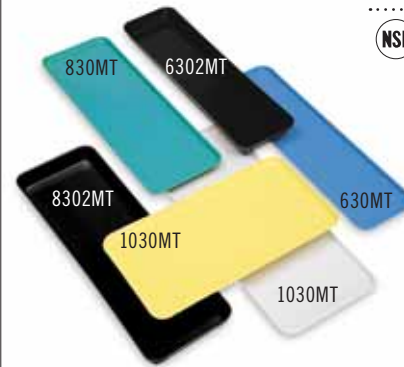

CODE	DIMENSIONS W x L x D	CASE PACK
Market Trays		
630MT*	16,4 x 76,2 x 1,9 cm	12
826MT*	21,6 x 64,1 x 1,9	12
830MT*	21,4 x 76,2 x 1,9	12
913MT*	22 x 31,6 x 2,1	12
918MT*	22 x 45,7 x 2,1	12
926MT*	22,5 x 64,9 x 2,5	12
1015MT*	25,7 x 38,1 x 1,9	24
1030MT*	26,5 x 76,2 x 1,9	12
1218MT*	29,2 x 45,1 x 2,5	12
1224MT*	31,6 x 61 x 1,9	12
1230MT*	31,6 x 76,2 x 1,9	12
1318MT*	32,1 x 45,1 x 2,7	12
1826MT*	45,2 x 65,2 x 2,7	6
2025MT*	52,7 x 64,9 x 2,1	6
Market Pans		
6302MT*	16,7 x 76,2 x 5,1	12
8262MT*	21,5 x 64,1 x 5,1	12
8302MT*	21,4 x 76,2 x 5,1	12
92615MT*	22,5 x 64,8 x 3,8	12
10302MT*	26,5 x 76,2 x 5,1	12



CAMBRO
Healthcare

The Cure for the Common Kitchen™



HEALTHCARE

Meal Delivery Ware

Reusable CamLids® for Meal Delivery Systems

Disposable CamLids®

Camshelving® Hygienic Drying Racks

Tablotherm Meal Delivery System

Antibacterial Camguard® Versa Trays

Polyester Decorated Versa Trays with Non-Slip Surface

Non-Slip Versa Lite Trays

Non-Slip Versa Camtrays®

Camtrays® with Handles

Polycarbonate Non-Slip Tray

Meal Delivery Carts for Tray Service





Why Cambro Healthcare?

For over 60 years Cambro has been focused on developing innovative solutions to the toughest challenges in the foodservice industry. Cambro Healthcare products are designed to perform consistently under the most demanding conditions of healthcare foodservice.

The Components for Successful Meal Service and Patient Satisfaction

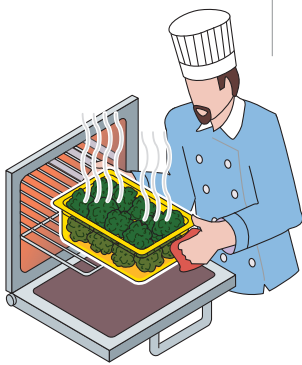
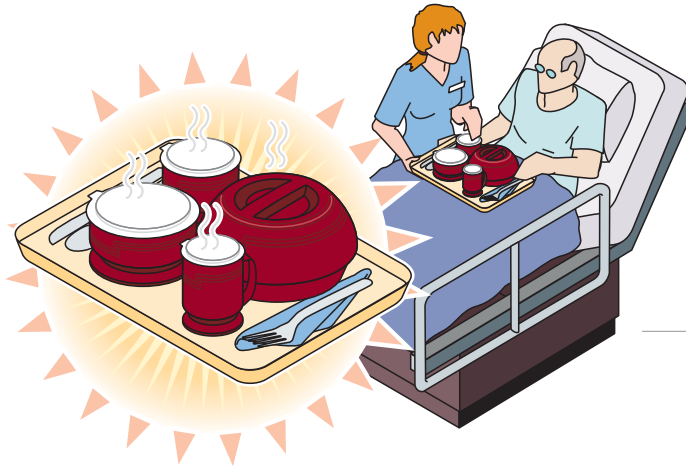

Hot Food

The goal of any meal delivery system is to keep food hot and fresh. Safe food handling and preparation are the first steps.

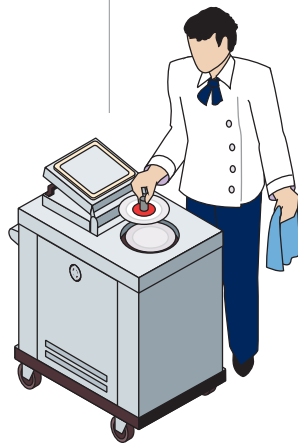

Hot Plate

Hot food needs a plate heated to proper temperatures. A plate that is not heated diminishes food quality for patients.

Plates should be heated between 65° and 77°C.

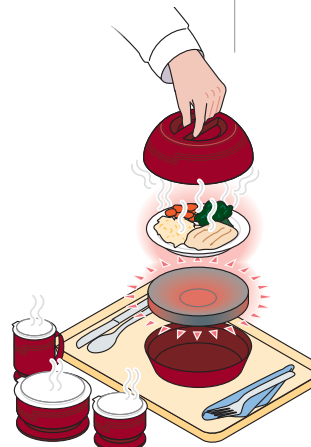

Temperature Maintenance System

NSF-listed, meal delivery ware consisting of mugs, bowls, insulated domes and heated bases/pellets specifically designed for healthcare foodservice are vital to temperature maintenance.

Bases and Pellets should be heated between 132° and 144°C.



Meal Transportation

From meal delivery carts to individual Tablotherm meal transport systems, these products can extend the heat retention of the meal to the patient's bedside.

Tablotherm Pellet System achieves temperature retention of 64°C for 2 hours.

TEMPERATURE RETENTION SYSTEMS



Insulated Dome

22,86 cm Ceramic Plate

Pellet Underliner

Camtherm Thermal Pellet

- Holds heat at its core to keep hot foods at safe temperatures.
- Stays 11°C cooler on the edge than metal pellets to protect staff and patients from burns.
- Is a high-density plastic composite that won't dent like metal pellets.
- Holds a 22,86 cm plate.

Color: Dark Gray (477).



Insulated Dome

22,86 cm Ceramic Plate

Heat Keeper Insulating Base

- Maintains heat for at least 20 minutes.
- Cost-effective solution to maintain meal delivery temperatures.
- Resists stains, odors and scratches.
- Holds a 22,86 cm plate.

Colors: Meadow (447), Wheat (457), Speckled Gray (480), Cranberry (487), Navy Blue (497), Black (110).



Low Profile Insulated Dome Comparison

Perfect for limited tray spacing as low as 11,43 cm

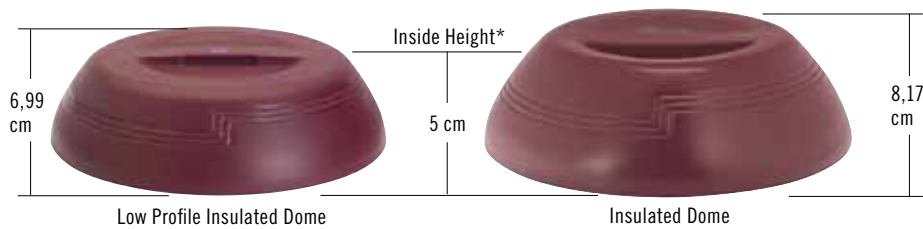

* This height is measured from a flat surface.

MEAL DELIVERY WARE

Camtherm® Thermal Pellet System

The perfect choice for maximum heat retention, holds temperature for 60 or more minutes.

Domes and Delivery Ware are made of durable polypropylene and not designed for microwave use.



CODE	MDS09	MDSL09	MDSL9	MDSPL9	MDS09
DESCRIPTION	Insulated dome covers 22,86 cm plate	Low profile insulated dome covers 22,86 cm plate	Pellet underliner holds 24,13 cm pellet	Ceramic plate	Thermal pellet holds 22,86 cm plate
OUTSIDE DIAMETER	25,94 cm	25,94 cm	24,29 cm	22,86 cm	24 cm
HEIGHT	8,17 cm	6,99 cm	4,6 cm	2,54 cm	4,45 cm
FULL-SIZE CAMRACK®	PR59314	PR59314	PR59314	PR59314	PR59314
CASE PACK	12	12	12	24	12

MDS09, MDSL09 and MDS09B Colors: Meadow (447), Wheat (457), Speckled Gray (480), Cranberry (487), Navy Blue (497), Black (110).

MDS09B Color: Dark Gray (477). MDS09B for use with CHP080.

MDSPL9 Color: White (148). MDSPL9 Sold in full cases only. MDSL9 and MDS09 are NSF listed.

Heat Keeper Insulating Base System

The cost-effective solution for heat retention, holds temperature for 20 or more minutes.



CODE	MDS09	MDSL09	MDSPL9	HK39B
DESCRIPTION	Insulated dome for 22,86 cm plate	Low profile insulated dome for 22,86 cm plate	Ceramic plate	Insulating base for 22,86 cm plate
OUTSIDE DIAMETER	25,94 cm	25,94 cm	22,86 cm	24,48 cm
HEIGHT	8,17 cm	6,99 cm	2,54 cm	4,07 cm
FULL-SIZE CAMRACK®	PR59314	PR59314	PR59314	PR59314
CASE PACK	12	12	24	12

MDS09, MDSL09 and HK39B Colors: Meadow (447), Wheat (457), Speckled Gray (480), Cranberry (487), Navy Blue (497), Black (110).

MDSPL9 Color: White (148). MDSPL9 Sold in full cases only. HK39B is NSF listed.

INSULATED ACCESSORIES (NSF)



CODE	MDSM8	MDSB5	MDSB9	MDSB16	MDSPL
DESCRIPTION	Insulated mug	Insulated sm. Bowl	Insulated lg. Bowl	Insulated entree bowl	Pellet lifter
APPROX. CAPACITY	240 mL	150 mL	270 mL	500 mL	—
OUTSIDE DIAMETER	8,89 cm	8,89 cm	11,11 cm	13,65 cm	8 cm
HEIGHT	10,16 cm	6,1 cm	6,1 cm	6,1 cm	7,6 cm
FULL-SIZE CAMRACK®	16C414	16C414	9S318	9S318	—
CASE PACK	48	48	48	48	1

* MDSM8 Diameter 11,43 cm with Handle. **MDSPL Color:** (000). * MDSPL is not NSF listed.

The Shoreline Collection Colors:



Safely lift hot, thermal pellets or plates with the Cambro Pellet Lifter.



REUSABLE CAMLIDS® FOR MEAL DELIVERY SYSTEMS

- Save up to 75% in lid costs each year.
- Reduce your waste-stream significantly each year when you switch from disposables to reusables.
- Dishwasher safe.
- Made of durable polypropylene.
- Contact your Cambro Sales Representative for a Customized Savings Calculator!

Reusable CamLids Colors:
Speckled White (490).

Camrack Wash and Store Rack Color:
Kelly Green (452).

Camrack Base Full Size Color:
Soft Grey (151).

Full Rack Cover Color: Grey (180).

CLRWSR36 is covered under U.S. patent D 617,069.

Full Rack Cover not NSF certified.



Visit www.cambro.com/savemoney for a Customized Savings Calculator!



Camrack® Wash and Store Rack

- Designed for safe and secure washing and storing of Reusable CamLids, CLRSB9 and CLRSM8B5 only.
- Each Camrack Wash and Store Rack holds 36 Reusable CamLids.
- 2 Wash and store Racks fit in a Full Size Base Rack.



CODE	DESCRIPTION	DIMENSIONS	CASE PACK
Reusable CamLids			
		H x Dia.	
CLRSM8B5	Fits Shoreline 240 mL mug and 150 mL bowl	0,71 x 9,05 cm	240
CLRSB9	Fits Shoreline 270 mL bowl	0,71 x 11,32	240
CLRSB16	Fits Shoreline 500 mL bowl	0,71 x 13,97	240
Accessories for CLRSM8B5 and CLRSB9			
		L x W x H	
CLRWSR36	Camrack wash and store rack to wash 36 reusable lids	20,96 x 45,4 x 13,97	4
BR578	Camrack full size base rack with 2 extenders	50 x 50 x 18,4	4
DRC2020	Full rack cover	50 x 50 x 2,4	1
Accessories for CLRSB16			
		L x W x H	
PR500	9 x 9 peg rack with 1 extender	50,17 x 50,17 x 14,29	5
E3	Full size open extender	50,17 x 50,17 x 2	12
CRPHDG2878	Full size square hold down grid	46,67 x 46,67	6

Reusable CamLids sold in cases only. No broken cartons.

DISPOSABLE CAMLIDS® FOR SHORELINE MADE OF HIGH IMPACT POLYSTYRENE (H.I.P.S.)



LID CODE	CLSM8B5	CLSB9	CLSSM8B5
DESCRIPTION	Sm. disp. lid	Lg. disp. lid	Disp. sip. lid
FITS	MDSB5, MDSM8	MDSB9	MDSB5, MDSM8
OUTSIDE DIAMETER	9,1 cm	11,28 cm	9,1 cm
HEIGHT	0,76 cm	0,76 cm	1,9 cm
CASE PACK	1,500	1,000	1,000

CLSM8B5, CLSB9 Color: Translucent (190). CLSSM8B5 Color: White (148).
Sold in full cases only. No broken cartons.

Disposable Lids for Laguna® Tumblers



LID CODE	CLLT6	CLLT10	CLLT12
FITS TUMBLERS	LT6	LT10	LT12
TUMBLER CAPACITY	177,4 mL	295,7 mL	354,9 mL
CASE PACK	1,500	1,000	1,000

Color: Translucent (190). Sold in full cases only. No broken cartons.

Disposable Lid for Swirl Bowls



LID CODE	CLSRB5
FITS SWIRL BOWLS	SRB5CW / SRB5
SWIRL BOWL CAPACITY	148 mL
CASE PACK	1,000

Color: Clear (152). Made of (P.E.T.).
Sold in full cases only. No broken cartons.

Disposable Lids for Colorware Tumblers



LID CODE	CLJ6	CL900P	CL950P
FITS TUMBLERS	500P / 500P2	900P / 900P2	950P / 950P2
TUMBLER CAPACITY	154 mL	287 mL	290 mL
CASE PACK	1,000	1,000	1,000

Color: Translucent (190). Sold in full cases only. No broken cartons.

Disposable Lids for Lido™ Tumblers



LID CODE	CLST6	CL900P
FITS TUMBLERS	LDT6	LDT9
TUMBLER CAPACITY	177 mL	266 mL
CASE PACK	36	36

Color: Translucent (190).
Sold in full cases only. No broken cartons.

Disposable Lids for Newport® Tumblers



LID CODE	CLNT5	CLNT8	CLNT10	CLNT12
FITS TUMBLERS	NT5	NT8	NT10	NT12
TUMBLER CAPACITY	189 mL	228 mL	300 mL	373 mL
CASE PACK	1,500	1,000	1,000	1,000

Color: Translucent (190). Sold in full cases only. No broken cartons.

CAMSHELVING® HYGIENIC DRYING RACKS



- Store products upright to promote faster and more sanitary drying and keep trayline and warewashing areas organized.
- Provides convenient sanitary storage, maximizes holding space.
- Non-corrosive, break resistant and easy to assemble.
- Mobile racks allow for easy floor clean up and maneuverability.
- Drying Cradles are removable and available separately to convert existing units to Drying Racks.
- Lifetime warranty against rust and corrosion on posts and traverses.
- Drying Cradles are made of high impact ABS material.

* **Camshelving Premium Series Colors:** Speckled Gray (480).
**** Camshelving Elements Series Colors:** Brushed Graphite (580).
***** Drying Cradle Color:** Soft Gray (151).

Casters:
 4 Premium Casters: (2 swivel with total locking brake, 2 swivel with no brake).



Vertical Drying and Storage Rack

- Securely holds various sizes of trays, cutting boards, baking sheet pans, lids and plates 20,5 to 34,3 cm.
- Drying Cradles are installed directly onto shelf traverses.

7-Slot Drying Cradle is covered by U.S. Patent D 663,912 S.



COMPONENT



CSDR7
 7-Slot Drying Cradle
 Width Per Slot: 3,3 cm



CPMU244875DRPKG
 Camshelving Premium



EMU244878DRPKG
 Camshelving Elements

CODE	DESCRIPTION	DIMENSIONS D x L x H	HOLDING CAPACITY	CASE PACK
Camshelving Premium*				
CPMU244875DRPKG	Vertical drying rack	610 x 1220 x 1980 mm	84 Trays	1
CPMU246075DRPKG	Vertical drying rack	610 x 1530 x 1980	105	1
Camshelving Elements**				
EMU244878DRPKG	Vertical drying rack	610 x 1220 x 1980	84	1
EMU246078DRPKG	Vertical drying rack	610 x 1530 x 1980	105	1
Drying Cradles***				
CSDR7	7-Slot drying cradle	597 x 260 x 95	—	1
CSDR73	7-Slot drying cradle	597 x 260 x 95	—	3

Drying Cradles fit on Camshelving Premium Series and Elements Series, mobile or stationary 610 mm deep shelves to 1830 mm in length. **Package Includes:** Pre-assembled mobile post kits, 6 traverses for each model (Elements Series includes mobile dovetails), 12 or 15 drying cradles and premium swivel casters with total locking brake. Assembly required.

CAMSHELVING® HYGIENIC DRYING RACKS

Angled Drying and Storage Rack

- Securely holds up to 128 meal delivery Pellets/Bases or a variety of food pan sizes, pots and kitchen wares.
- Drying Cradles are installed directly onto shelf traverses.

8-Slot Drying Cradle is covered by U.S. Patent D739,989 S.



COMPONENT



CSDR8
8-Slot Drying Cradle
Width Per Slot: 6 cm

New!



MPMU61217PDPKG
Camshelving Premium

CODE	DESCRIPTION	DIMENSIONS D x L x H	HOLDING CAPACITY	CASE PACK
Camshelving Premium*				
CPMU244875PDPKG	Angled drying rack	610 x 1220 x 1980 mm	128 Pellets and bases or 16 GN 1/1 food pans	1
Camshelving Elements**				
EMU244878PDPKG	Angled drying rack	610 x 1220 x 1980	128 Pellets and bases or 16 GN 1/1 food pans	1
Drying Cradles***				
CSDR8	8-Slot drying cradle	592 x 263 x 160	—	1
CSDR84	8-Slot drying cradle	592 x 263 x 160	—	4

Camshelving Premium: Units ship complete with 2 mobile post kits, 8 traverses, 16 angled drying cradles and premium swivel casters with total locking brake. Assembly required. **Camshelving Elements:** Unit ships complete with factory assembled mobile post kits, 8 mobile shelf traverses, mobile shelf traverse dovetails, 16 angled drying cradles and premium swivel casters with total locking brake. Assembly required.



EMU244878PDPKG
Camshelving Elements

Dome Drying and Storage Rack

- Securely holds 100 meal delivery domes.
- Drying Cradles are installed directly onto shelf traverses.

10-Slot Drying Cradle is covered by U.S. Patent D 736,488 S.



COMPONENT



CSDDC
10-Slot Drying Cradle
Width Per Slot: 7.8 cm

New!



CPMU213675DDPKG
Camshelving Premium

CODE	DESCRIPTION	DIMENSIONS D x L x H	HOLDING CAPACITY	CASE PACK
Camshelving Premium*				
CPMU213675DDPKG	Dome drying rack	540 x 910 x 1910 mm	100 Domes	1
Drying Cradles***				
CSDDC	10-Slot drying cradle	520 x 415 x 86	—	1
CSDDC5	10-Slot drying cradle	520 x 415 x 86	—	5

Individual Dome Drying Cradles fit on Camshelving Premium and Camshelving Elements Series 540 mm deep shelves only. **Package Includes:** Pre-assembled mobile post kits, 10 traverses, 10 drying cradles and premium swivel casters with total locking brake. Assembly required. **Fits only Camshelving Premium Series made in the USA. Special Order. Allow 10 to 12 weeks for delivery for International delivery.**

TABLOTHERM MEAL DELIVERY SYSTEM

The ideal single-serve meal delivery system for in-home service

- Transport and serve hot and cold food in one complete unit.
- Maintain safe food temperatures for over 1 hour.
- Lightweight design makes transportation easy and convenient.
- Two sizes accommodate a variety of meal options.
- Dishwasher safe.



Tablotherms stack for easy transportation and storage.



Molded-in dimples secure the sealed lids on dishware to prevent spills and enhances temperature retention.

CFC-free foamed-in insulation.

Break-resistant china dishware.

Compact design makes transport easy.

Safely hold hot and cold meals in one unit.



Meal set-up is convenient with Tablotherm trays and dishes.



Tablotherms are designed for dining comfort.

TABLOTERM INSULATED TRAYS

SPECIFICATIONS

Material	Polypropylene + Foam Insulation
Characteristic	Insulated Tray
Performance	Excellent
Heat Retention	Approximately 60 Minutes*
Dishwasher Safe	Yes
Stackable	Yes
Minimum Food & Plate Temperature before Plating	85° - 90°C
Individual Dish Cover	Yes – Prevent Spilling of Soup and Sauces



* With heated pellet.
Not for use in heated carts.

ITPD3253 model with Heated Pellet	85°C	80°C	77°C	74°C	71°C
ITPD3253 model without Heated Pellet	85°C	72°C	68°C	64°C	—
ITPD3753T model with Heated Pellet	89°C	75°C	70°C	65°C	62°C
ITPD3753T model without Heated Pellet	87°C	67°C	60°C	—	—



Only available from Cambro
European Logistics (CEL), Germany.



ITPD3253 - Gastronorm size



ITPD3753T - Euronorm size



Light gray polypropylene lid with integrated rubber seal. Lids cannot be used in microwave oven.

For a complete guide to maximizing heat retention, contact your Cambro representative.

CODE	DESCRIPTION	DIMENSIONS W x L x H
Tablotherm – Insulated Tray with Porcelain Dishes, seal covers and pellet		
ITPD3753T	Euronorm insulated tray including: 1 ea. two-compartment plate (122 400 050), 1 ea. reusable cover (122 600 050), 1 ea. Pellet (165PW), 3 ea. multi-purpose bowls: 2 ea. 400 mL (122 500 050), 1 ea. 500 mL (122 450 050) and 3 ea. reusable covers: 2 ea. (122 700 050) and 1 ea. (122 650 050)	37 x 53 x 10,5 cm
ITPD3253	Gastronorm insulated tray including: 1 ea. two-compartment plate (122 400 050), 1 ea. reusable cover (122 600 050), 1 ea. pellet (165PW) 2 ea. multi-purpose bowl (122 500 050) and 2 ea. reusable cover (122 700 050)	32,5 x 48 x 10,5
Tablotherm – Insulated Tray without porcelain dishes, seal covers and pellet		
IT3753T	Euronorm insulated tray – empty	37 x 53 x 10,5
IT3253	Gastronorm insulated tray – empty	32,5 x 48 x 10,5
Porcelain dishes		
122 400 050	Two compartment plate. Outside ø 254 mm capacity 750 mL (white)	—
122 450 050	Multi-purpose bowl. Outside ø 142,2 mm capacity 500 mL (white)	—
122 500 050	Multi-purpose bowl. Outside ø 120 mm capacity 400 mL (white)	—
Reusable polypropylene covers, light gray with integrated rubber seal		
122 600 050	For two compartment plate	—
122 650 050	For multi-purpose bowl – 500 mL	—
122 700 050	For multi-purpose bowl – 400mL	—
Pellet System		
165PW	SMC pellet ø 16,5 cm	—
Menu card		
112 430 000	Yellow menu cards 100 x 70 mm	—
Latches		
122 201 050	Latches with menu card holder (IT3253, ITPD3253)	—
122 200 050	Latches without menu card holder (IT3753T, ITPD3253)	—
122 260 050	Latches and screw kit: 1 ea. latch, 4 ea. screws (IT3753T, ITPD3753T)	—

ITPD3753T, IT3753T Color: Gray and Blue. ITPD3253, IT3253 Color: Two Tone Gray. 165PW Color: A42 165PW Case Pack: 1 Each.

ANTIBACTERIAL CAMGUARD® VERSA TRAYS

- High performance polyester tray for ultra-intensive use.
- Built-in antibacterial protection eliminates bacteria between tray washings and will not wash off or wear away for the life of the tray.
- Reinforced polyester corners provide superior corner and edge protection against impact.
- Stacking lugs allow air circulation for fast drying and perfect stacking.
- Temperature range resistance from -40° to 140°C.‡
- Dishwasher safe – Wash as often and as frequently as needed.

‡ Not for use in heated carts.



PRORATED

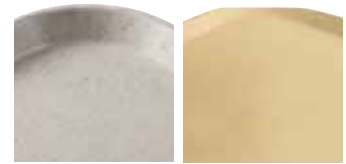

High Profile Shape

Low Profile Design Shape



Flat Edge Shape



camguard

ANTIMICROBIAL TRAYS

Trays have built-in antimicrobial properties to protect against mildew growth and bacterial odors. This protection will not wash or wear off.

Unprotected Surface versus Camguard Treated Surface 24 Hour Test.

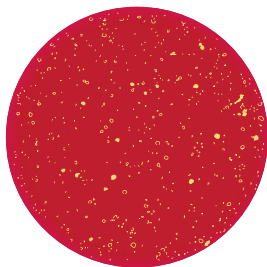

Unprotected

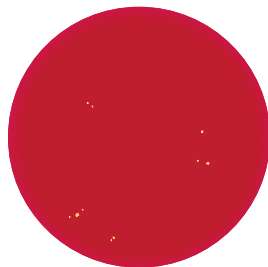

Protected with Camguard

CODE

DIMENSIONS

Versa Trays – High Profile Shape

VT1418AB	35,5 x 45,7 cm
VT3343AB	33 x 43

Versa Century™ Trays – Low Profile Design Shape

VT3646CAB	35,5 x 45,7
VT3343CAB	32,9 x 42,9

Versa Trays – Flat Edge Shape

GP1070AB*	26,5 x 32,5
GP1080AB*	26,5 x 37
GP3980AB*	37 x 53
GP4002AB*	32,5 x 53

Case Pack: 12

* Designed with reinforced corners for automatic off-stacking onto conveyor belt dishwashers.



Innovative low profile and low corner design increases space utilization of tray surface and customer comfort while eating.



Reinforced polyester corners provide superior corner and edge protection against impact.



Stacking lugs keep trays stacked securely in place and ensure proper air flow.

Tray Color:



A83

Granite

POLYESTER DECORATED VERSA TRAYS WITH NON-SLIP SURFACE

- Reduce waste, save money and provide a stable tray surface for meal delivery.
- Switching from paper tray mats will generate annual savings of over 50%.
- Your Green Initiatives will get rapid results with the elimination of up to 10 tons of trash each year.
- High performance polyester tray for ultra-intensive use.
- Reinforced polyester corners provide superior corner and edge protection against impact.
- Stacking lugs allow air circulation for fast drying and perfect stacking.
- Temperature range resistance from -40° to 80°C.‡
- Dishwasher safe – Wash as often and as frequently as needed.

‡ Not for use in heated carts.

Personalization: Contact your Cambro representative for pricing.



Flat Edge Shape



CODE	DIA/ SIZE	CASE PACK
Versa Trays – Flat Edge Shape		
GP3980NS*	37 x 53 cm	12
GP4002NS*	32,5 x 53	12
GP0540NS*	34,4 x 46	12
GP1080NS*	26,5 x 37	12

* Designed with reinforced corners for automatic off-stacking onto conveyor belt dishwashers.



Non-Slip Trays grip firmly providing safer meal delivery service.

Patterns and Tray Base Colors:



B22
Sahara on
Sahara Tray

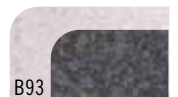

B93
Titan on
Granite Tray



B31
Lava on Speckled
Blue Tray



B99
Pebbled Black on
Light Grey Tray



B100
Pebbled Black on
Terrazzo Tray

POLYESTER NON-SLIP VERSA LITE TRAYS

- Non-Slip surface provides a better grip for safer meal delivery.
- Reduce your environmental waste-stream each year when you switch from paper tray mats to Non-Slip Versa Lite Trays.
- Standard performance polyester tray for intensive use.
- Reinforced polyester corners provide superior corner and edge protection against impact.
- Stacking lugs allow air circulation for fast drying and perfect stacking.
- Temperature range resistance from -40° to 80°C.‡
- Dishwasher safe – Wash up to 3 times per day.

Colors: Sahara on Sahara Tray (B22), Titan on Speckled Smoke Tray (B14), Sahara on Pearl White Tray (B11), Pebbled Black on Light Grey Tray (B99).

Personalization: Contact your Cambro representative for pricing.

‡ Not for use in heated carts.



PRORATED

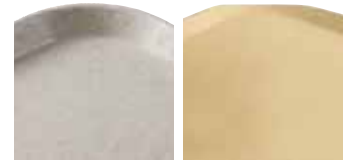

High Profile Shape

Low Profile Design Shape



Flat Edge Shape



Versa Lite Century Trays have low edges and ergonomic corners that enhance comfort.



Stacking lugs keep trays stacked securely in place and ensure proper air flow.



Reinforced polyester corners provide superior corner and edge protection against impact.

Tray Colors:



B22
Sahara on Sahara Tray

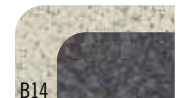

B14
Titan on Speckled Smoke Tray

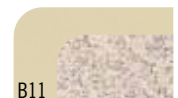

B11
Sahara on Pearl White Tray



B99
Pebbled Black on Light Grey Tray



Non-Slip Trays grip firmly providing safer meal delivery service

CODE	DIMENSIONS
Versa Lite Trays – High Profile Shape	
VL1418NS	35,5 x 45,7 cm
VL3343NS	33 x 43
Versa Lite Century™ Trays – Low Profile Design Shape	
VL3646CNS	35,5 x 45,7
VL3343CNS	33 x 43
Versa Lite Trays – Flat Edge Shape	
GL3980NS*	37 x 53
GL4002NS*	32,5 x 53

Case Pack: 12

* Designed with reinforced corners for automatic off-stacking onto conveyor belt dishwashers.

NON-SLIP VERSA CAMTRAYS®

- Non-Slip Trays reduce waste, save money and provide a stable tray surface for meal delivery.
- Switching from paper tray mats will generate annual savings over 50%.
- Green Initiatives will get rapid results with the elimination of tons of trash each year.
- Non-Slip Camtrays provide a better grip for safer meal delivery.
- Dishwasher safe in low and high temperatures.
- Stacking lugs allow for quick drying.
- Temperature range resistance from -40° to 80°C.‡

Camtray and Dietary Tray Colors:
Black with Pebbled Black (382),
Pearl Gray with Titan (381),
Ivory with Sahara (380).

Personalization: Contact your Cambro representative for pricing.

‡ Not recommended for heated carts.

NSF Listed for non-direct food contact only.



Non-Slip trays grip table top items firmly.



High Profile Shape Flat Edge Shape



CODE	DESCRIPTION	DIMENSIONS
1418VC	Non-Slip Versa Camtray	35,5 x 45,7 cm
1520VC	Non-Slip Versa Camtray	38 x 51

Case Pack: 12

NON-SLIP VERSA CAMTRAYS FOR ROOM SERVICE

- Ergonomic handles allow for safe and elegant meal delivery.
- Trays fit within existing meal delivery carts that accommodate 36 x 46 or 38 x 51 cm trays.
- Non-Slip surface eliminates the need for tray mats saving time and money.
- Dishwasher safe at high and low temperatures.
- Stacking lugs allow for quick drying.
- Temperature range resistance from -40° to 80°C.‡
- 38 x 51 cm tray is ideal for room service.

Room Service Tray Colors:
Black with Pebbled Black (382),
Pearl Gray with Titan (381),
Ivory with Sahara (380).

Personalization: Contact your Cambro representative for pricing.

‡ Not recommended for heated carts.

Non-Slip Versa Camtrays for Room Service is covered by U.S. Patent D 683,191 S.

NSF Listed for non-direct food contact only.



Black with Pebbled Black (382)

Pearl Gray with Titan (381)

Ivory with Sahara (380)

CODE	DESCRIPTION	DIMENSIONS
1418VCH New!	Non-Slip Versa Camtray with handles	36 x 46 cm
1520VCRST New!	Non-Slip Versa Camtray with handles	38 x 51

Case Pack: 12



CAMTRAYS® WITH HANDLES

- Enhance your tray presentation with these easy-to-grip, ergonomic, contoured handles.
- Stain, Scratch and odor resistant.
- Made of durable lightweight and high-impact fiberglass.
- Stacking lugs keep trays in place and ensure proper airflow between trays.
- Dishwasher safe at high and low temperatures.

Available in Group I colors.
Special order item not carried in stock, non-returnable. One case order minimum.

NSF listed for non-direct food contact only.

Personalization through digital printing process only. Please refer to Camtray Personalization section for details.

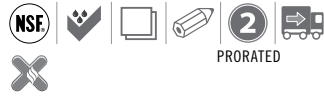

1520H

CODE	DESCRIPTION	DIMENSIONS
1418H	Camtray with handles	36 x 46 cm
1520H	Camtray with handles	38 x 51

Case Pack: 12

POLYCARBONATE NON-SLIP TRAY

- Ideal for healthcare patient meal delivery and in high-traffic cafeterias.
- Scratch-resistant, made of virtually unbreakable polycarbonate.
- Non-Slip eliminates the need for tray mats, saving time and money.
- Enhances stability, providing safer transport and service.
- Stacking lugs keep trays in place and ensure proper airflow between trays.
- Commercial dishwasher safe at high and low temperatures.

Colors: Black (110), Dark Cranberry (488).

Durable construction backed by a three (3) year pro-rated warranty.

NSF Listed for non-direct food contact only.



Black (110)

Dark Cranberry (488)



CODE	DESCRIPTION	DIMENSIONS
1418CWNS	Polycarbonate non-slip tray	35,5 x 46 cm
1520CWNS	Polycarbonate non-slip tray	38 x 51

Case Pack: 12

MEAL DELIVERY CARTS FOR TRAY SERVICE

- Transport meal trays from the kitchen to acute care patients, nursing home residents or correctional facility inmates.
- Enhance patient satisfaction with high quality, room service style meals served quietly and efficiently.
- Tough, one-piece, double-wall polyethylene carts are easy to clean and won't rust, dent, crack, chip or break.
- Non-electric and requires no assembly.
- Features light-weight non-insulated ABS doors.
- Features standard stainless steel non-marking casters (MDC1411T60 comes standard with plated casters).

10-Tray Meal Delivery Cart is covered by U.S. Patent D 723,237 S.



10-TRAY MEAL DELIVERY CART FOR ROOM SERVICE – LOW PROFILE

Large, molded-in ergonomic handle makes it easy to transport and maneuver.

Molded-in marine rail creates additional work surface during service. Marine rail is designed for use during service, not transport.

Polyurethane insulation ensures quiet meal delivery and provides structural strength.

Molded-in rails ensure quiet meal delivery, rail spacing up to 13,34 cm.

Shown with four, 13 cm non-marking, offset, durable stainless steel casters (2 fixed and 2 swivel with brake). Heavy duty casters are available.

Lightweight, self-venting, ABS door is non-insulated and opens a full 270°.

One louvered vent on the back supports air circulation.

Molded-in full-perimeter bottom bumper protects the cart, walls & furniture.

Menu clip holds routing directions or content lists.

CODE	MDC1520S10	MDC1520S10HD
TRAY SIZE	38 x 51,5 cm & 37 x 53 cm	38 x 51,5 cm & 37 x 53 cm
TRAYS PER RAIL / RAIL SPACING	2 / 13,3 cm	2 / 13,3 cm
EXTERNAL DIMENSIONS W x D x H	72,4 x 97,8 x 108 cm	72,4 x 97,8 x 110,5 cm
INTERNAL DIMENSIONS W x D x H	53,7 x 78,7 x 66,7 cm	53,7 x 78,7 x 66,7 cm
CASTER TYPE	Standard casters 12,7 x 3,2 cm	Heavy duty casters 15,24 x 5,1 cm
UNIT WEIGHT	35,4 kg	40,8 kg

Case Pack: 1 Colors: Granite Gray (191) and Granite Sand (194).

20-TRAY MEAL DELIVERY CART – LOW PROFILE



Colors: Slate Blue (401), Granite Grey (191), Granite Green (192), Granite Sand (194).
(All carts with cream door.)

MDC1520T16 and MDC1418T16 are covered by U.S. Patent D 398,727.



Marine rail is designed for use during service, not transport.



MDC1520S20
Back view with louvered vents



Low Profile

CODE	MDC1520S20	MDC1418S20
TRAY SIZE	38 x 51,5 cm	36 x 46 cm
TRAYS PER CART	20	20
TRAYS PER COMPARTMENT	10	10
RAILS PER COMPARTMENT	5	5
TRAYS PER RAIL	2	2
RAIL SPACING	13,9 cm	13,9 cm
NUMBER OF DOORS	2	2
NUMBER OF COMPARTMENTS AND VENTS	2	2
NUMBER OF MENU CLIPS	2	2
MENU CLIPS - LOCATION	1 per door	1 per door
HANDLES - TYPE AND LOCATION	Molded in, each end	Molded in, each end
CASTER TYPE	15,2 cm, 2 swivel w/brake, 2 rigid, offset	12,7 cm, 2 swivel w/brake, 2 rigid, offset
LATCHES	2 internal nylon friction	2 internal nylon friction
EXTERNAL DIMENSIONS W x L x H	96,5 x 140 x 112,4 cm	82,6 x 123,2 x 111,8 cm
INTERNAL DIMENSIONS W x D x H	53,5 x 77 x 70 cm	47 x 71,5 x 74 cm
UNIT WEIGHT	70,31 kg	64,18 kg

Case Pack: 1

16 AND 30 TRAY MEAL DELIVERY CARTS – TALL PROFILE



Marine rail is designed for use during service, not transport.



Tall Profile

CODE	MDC1520T30	MDC1520T16	MDC1418T30	MDC1418T16
TRAY SIZE	38 x 51,5 cm	38 x 51,5 cm	36 x 46 cm	36 x 46 cm
TRAYS PER CART	30	16	30	16
TRAYS PER COMPARTMENT	10	8	10	8
RAILS PER COMPARTMENT	10	4	10	4
TRAYS PER RAIL	1	2	1	2
RAIL SPACING	12,7 cm	13,3 cm	12,7 cm	13,3 cm
NUMBER OF DOORS	3	1	3	1
NUMBER OF COMPARTMENTS	3	2	3	2
NUMBER OF MENU CLIPS	5	1	5	1
MENU CLIPS - LOCATION	Each door, each end	Back of cart	Each door, each end	Back of cart
HANDLES - TYPE AND LOCATION	Heavy-duty nylon, mounted 1 per end	Molded-in, 1 per end	Heavy-duty nylon, mounted 1 per end	Molded-in, 1 per end
CASTER TYPE	15,2 cm, 2 rigid, 4 swivel w/brake, offset	15,2 cm, 2 rigid, 2 swivel w/brake	15,2 cm, 2 rigid, 4 swivel w/brake, offset	15,2 cm, 2 rigid, 2 swivel w/brake
LATCHES	Friction catch, transit latch*	Large paddle latch external security latches	Friction catch, transit latch*	Large paddle latch
EXTERNAL DIMENSIONS W x L x H	74,3 x 152,4 x 161,6 cm	74,3 x 152,4 x 161,6 cm	99,4 x 77,8 x 147,6 cm	92,7 x 71,1 x 147,6 cm
INTERNAL DIMENSIONS W x D x H	39 x 53,34 x 127 cm	52,5 x 55 x 77,5 cm	37 x 55 x 127 cm	46,5 x 55 x 74,6 cm
REQUIRED DOOR WIDTH	77 cm	79 cm	77 cm	73 cm
UNIT WEIGHT	95,25 kg	62,37 kg	97,07 kg	54,88 kg

Case Pack: 1 Colors: Slate Blue (401), Granite Grey (191), Granite Green (192), Granite Sand (194). (All carts with cream door.)

* Stainless steel transit latch at top of each door. MDC1520T16 and MDC1418T16 are covered by U.S. Patent D 398,727.

For lighter-duty applications, 30-tray carts may be ordered without the steel transit latches by using product code MDC1520T30NL or MDC1418T30NL.

60-TRAY MEAL DELIVERY CART FOR CORRECTIONAL TRAY SERVICE

- For use in correctional facilities.
- Holds 60 each 1411CW or 1411CP Cambro Base Trays with 853 Insert Trays or 60 each 10146DCW or 10146DCP Separator Compartment Trays.
- Security features include security screws on handles, stop locks on door knuckles, security bolts for transit latches and caster carriage bolts with lock nuts.



1411CP base tray with 853FH insert tray

CODE	MDC1411T60
TRAY SIZE	36,5 x 26,8 cm base tray 1411CW and 1411CP
TRAYS PER CART	60
TRAYS PER COMPARTMENT	20
RAILS PER COMPARTMENT	10
TRAYS PER RAIL	2
RAIL SPACING	12,7 cm
NUMBER OF COMPARTMENTS	3
MENU CLIPS	None
HANDLES - TYPE AND LOCATION	Heavy-duty aluminum with security screws, black finish, 1 per end
CASTER TYPE	15,2 cm heavy-duty casters, 5 cm wide tread, 2 swivel no brake, 2 rigid
LATCHES	Internal friction catch, 2 per door, transit latch***
EXTERNAL DIMENSIONS W x L x H	74,3 x 152,4 x 161,6 cm
INTERNAL DIMENSIONS W x D x H	37 x 55 x 127 cm
REQUIRED DOOR WIDTH	76,2 cm
UNIT WEIGHT KG	97,98 kg

Case Pack: 1 **Colors:** Slate Blue (401), Granite Grey (191), Granite Green (192), Granite Sand (194). *** Stainless steel transit latch at top of each door.

MEAL DELIVERY CARTS FEATURES AND CASTER CONFIGURATIONS

Standard Caster Configurations:

These caster configurations are designed to provide stability and maneuverability over uneven surfaces.

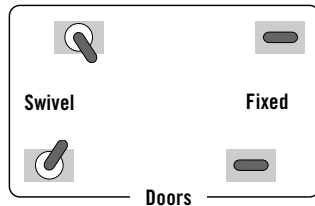

MDC1520S20, MDC1418S20,
MDC1411T60

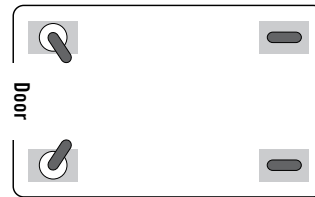

MDC1520S10*, MDC1520T16,
MDC1418T16

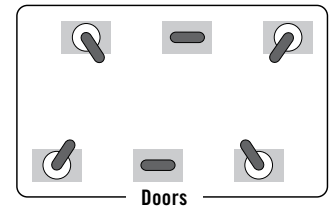

MDC1520T30, MDC1418T30

Optional Caster Configurations*:

These caster configuration options are alternative designs if facility or environment requires the need to change.

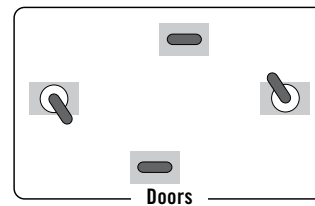

MDC1520S20, MDC1418S20

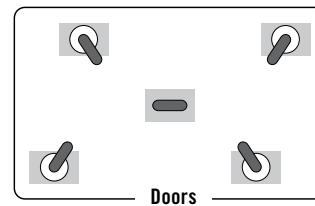

MDC1520S20, MDC1418S20,
MDC1520T30, MDC1418T30, MDC1411T60

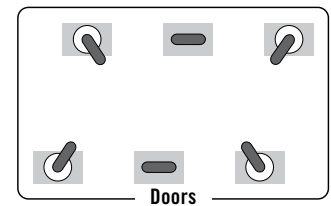

MDC1520S20, MDC1418S20,
MDC1411T60

* All optional caster configurations are special order items and therefore non-returnable.

Handles

MDC1520S20, MDC1418S20



Molded in handles on each end for smooth transporting.

MDC1520T16, MDC1418T16



Molded in handles for easy transporting.

MDC1520T30, MDC1418T30, MDC1411T60**



Heavy duty nylon handles are securely mounted and nested into each end.
** MDC1411T60 has tamper resistant heavy duty aluminum tubing handles.

LEAD IN CASTERS



Castors are offset to ease movement over uneven surfaces. This is standard on MDC1520S10, MDC1520S20, MDC1418S20, MDC1520T30, MDC1418T30 and MDC1411T60.

ALPHA NUMERICAL LISTING

CODE	PAGE	CODE	PAGE	CODE	PAGE	CODE	PAGE
46	211	100MPC	17	122 201 050	36, 245	1600P2	174
46 (Group 3)	211	100MPCHL	17	122 250 050	36, 245	1600TL	220
57	211	100VS	166	122 400 050	36, 245	1621CBP	80
57 (Group 3)	211	1010VS	166	122 450 050	36, 245	1621CBR	80
810	211	1012VS	166	122 500 050	36, 245	1622CT	219
810 (Group 3)	211	1013CW	166	122 600 050	36, 245	165PW	36, 245
900	212	10145CW	233	122 650 050	36, 245	16C258	64, 68
900 (Group 3)	212	10146CW	229, 233	122 700 050	36, 245	16C414	64
915	211	10146DCP	231	1220D	217	16C578	64
915 (Group 3)	211	10146DCPC	231	1220D (Group 3)	217	16CW	149
926	211	10146DCW	231	1222D	217	16E1	68
926 (Group 3)	211	10146DCWC	231	1222D (Group 3)	217	16E2	69
1000	212	1014CL	217	1224MT	233	16E4	69
1000 (Group 3)	212	1014CT	219	1230MT	233	16E5	69
1014	211	1014FF	228	124VS	166	16HP	153
1014 (Group 3)	211	1014VS	166	1252SLB250	159	16PP	157
1015	211	1015MT	233	1252SLINB250	159	16S1058	60
1015 (Group 3)	211	10302MT	233	12CW	149	16S1114	60
1100	212	1030MT	233	12HP	153	16S1214	60
1100 (Group 3)	212	103VS	166	12HPP	154	16S318	60
1116	211	105VS	166	12PP	157	16S418	60
1116 (Group 3)	211	106VS	166	12RS12	49	16S434	60
1200	212	10CW	165	12SFSCW	138	16S534	60
1200 (Group 3)	212	10CWC	151	12SFSP	139	16S638	60
1216	211	10CWCH	151	12SFSP	139	16S738	60
1216 (Group 3)	211	10CWCHN	151	12TGS	187	16S800	60
1300	212	10CWD	149	1318MT	233	16S900	60
1300 (Group 3)	212	10CWGL	151, 155	1318MTC	35	16S958	60
1313	211, 213	10CWL	165	13CLRCW	150	1722CBCP	80
1313 (Group 3)	211, 213	10CWNR	165	13CLRHP	154	1722CBP	80
1318	211	10HC258	64, 68	1400CT	219	1722CBR	80
1318 (Group 3)	211	10HC414	64	1400TL	220	17HE1	69
1400	212	10HE1	69	14105CP	233	17HE2	69
1400 (Group 3)	212	10HE2	69	14105CW	233	17HS1114	63
1418	211	10HPC	155	1411CP	232	17HS318	63
1418 (Group 3)	211	10HPCH	155	1411CW	232	17HS434	63
1520	211	10HPCHN	155	14187TRCW	233	17HS638	63
1520 (Group 3)	211	10HPD	153	1418CL	217	17HS800	63
1550	212	10HS1114	63	1418CT	219	17HS958	63
1550 (Group 3)	212	10HS318	63	1418CW	218	1800CT	219
1600	212	10HS434	63	1418CWNS	218, 250	182612CW	146
1600 (Group 3)	212	10HS638	63	1418D	217	182612P	147
1622	211	10HS800	63	1418D (Group 3)	217	182615CW	146
1622 (Group 3)	211	10HS958	63	1418FF	228	182615P	147
1826	211	10PPCH	157	1418H	213, 250	18263CW	146
1826 (Group 3)	211	10PPCWSC	151, 157	1418TR	212	18263P	147
1950	212	10PPD	157	1418TR (Group 3)	212	18266CW	146
1950 (Group 3)	212	1100CT	219	1418TRCW	218	18266P	147
2025	211	1101CW	166	1418VC (Group 3)	216, 249	18268CLRCW	147
2025 (Group 3)	211	112 430 000	36, 245	1418VCH (Group 3)	216, 249	18268CLRKIT	147
2500	212	1120CBP	80	1422TR	212	18269CW	146
2500 (Group 3)	212	1120CBR	80	1422TR (Group 3)	212	18269P	147
2632	213	116VS	166	14CW	149	1826CCW	146
2632 (Group 3)	213	1200CW	175	14HP	153	1826CL	217
2700	212	1200DIV	18, 23, 48	14PP	157	1826CLRCW	147
2700 (Group 3)	212	1200P	174	150CW	165	1826CP	147
3046	213	1200P2	174	1520CBCP	80	1826CT	219
3046 (Group 3)	213	1202CW	166	1520CBP	80	1826DBC	34
3242	213	120CWP	165	1520CBPF	80	1826DBCSP	34
3242 (Group 3)	213	120VS	166	1520CBR	80	1826DSCW	147
3253	213	1210PW	18, 20, 21, 23	1520CL	217	1826DTC	34
3253 (Group 3)	213	1216CL	217	1520CT	219	1826DTCSP	34
3343	213	1216CT	219	1520CW	218	1826HAR	35
3343 (Group 3)	213	1216D	217	1520CWNS	218, 250	1826LBC	35
3753	213	1216D (Group 3)	217	1520D	217	1826LBCSP	35
3753 (Group 3)	213	1216FF	228	1520D (Group 3)	217	1826LTC	35
3853	213	1217FFH	228	1520H	213, 250	1826LTC3	35
3853 (Group 3)	213	12183CW	146	1520TR	212	1826LTCSP	35
16225	211	12183P	147	1520TR (Group 3)	212	1826MT	184, 233
16225 (Group 3)	211	12186CW	146	1520VC (Group 3)	216, 249	1826MTC	35
1000CW	166	12186P	147	1520VCRST (Group 3)	216, 249	1826SCCW	146
1000LCD	13	12189CW	146	1525RST	224	18CW	149
1000LLDCVR	13	12189P	147	1550CT	219	18PP	157
1005CW	166	1218CCW	146	1596CP	230	18SFSCW	138
1007CW	166	1218CP	147	1596CW	230	18SFSP	139
100BC	49	1218DSCW	147	15CLRCW	150	18SFSP	139
100BC1	49	1218MT	233	15CLRHP	154	1950CT	219
100BCS	49	1218SCCW	146	1600CT	219	2000P	174
100CW	165	1219D	217	1600CW	175	2000P2	174
100LCD	13, 15	1219D (Group 3)	217	1600DIV	18, 23, 45	200BC	49
100MCCW	162	122 200 050	36, 245	1600P	174	200BC1	49

ALPHA NUMERICAL LISTING

CODE	PAGE	CODE	PAGE	CODE	PAGE	CODE	PAGE
200BCS	49	25E5	69	36S318	62	6302MT	233
200MCCW	162	25MCCW	162	36S418	62	630MT	233
2025MT	233	25S1058	61	36S434	62	63CLRCW	150
2030UT	74	25S1114	61	36S534	62	63CLRHP	154
20C258	64, 68	25S1214	61	36S638	62	64CW	149
20C414	64	25S318	61	36S738	62	64HP	153
20CC	174	25S418	61	36S800	62	64PP	157
20CFC	158	25S434	61	36S900	62	650WS	52
20CWC	151	25S534	61	36S958	62	65CLRCW	150
20CWCH	151	25S638	61	38CW	149	65CLRHP	154
20CWCHN	151	25S738	61	38PP	157	65CWNR	165
20CWD	149	25S800	61	400DIV	18, 20, 21, 23	66CF	158
20CWGL	151, 155	25S900	61	400MCCW	162	66CW	149
20CWL	151	25S958	61	400STP	20, 21, 27, 74	66HP	153
20CWLN	151	25SWGf	65	40CWC	151	66PP	157
20E2	69	26CF	158	40CWCH	151	68VS	166
20GE1	68	26CW	149	40CWCHN	151	6F	183
20GE2	69	26HP	153	40CWD	149	6FBRTT	42
20GE4	69	26PP	157	40HPC	155	6RS6	49
20GE5	69	2700CT	219	40HPCH	155	6SFSCW	138
20HPC	155	28CW	149	40HPCHN	155	6SFSP	139
20HPCH	155	28PP	157	40HPD	153	6SFSP	139
20HPCHN	155	2900CT	219	40PPCH	157	6TGS	187
20HPD	153	29FSCW	138	40PPCHN	157	725CWNR	165
20HPL	155	29FSP	139	40PPCWS	151, 157	730SR	52
20HPLN	155	29FSP	139	40PPD	157	730STP	48
20LPCWC	151	300DIV	18, 20, 23	415CBP	80	730WS	52
20LPCWD	149	300MPC	20	42CW	149	75CW	165
20LPHPC	155	30CFC	158	42HP	153	800CW	175
20LPHPD	153	30CWC	151	42PP	157	800P	174
20PPCH	157	30CWCH	151	44CW	149	800P2	174
20PPCWSC	151, 157	30CWCHN	151	44HP	153	806CW	166
20PPD	157	30CWD	149	44PP	157	80CWC	151
20S1058	61	30CWGL	151, 155	45CW	165	80CWCH	151
20S1114	61	30CWL	151	46CW	149	80CWCHN	151
20S1214	61	30CWLN	151	46HP	153	80CWD	149
20S318	61	30GE1	68	46PP	157	80HPC	155
20S418	61	30GE2	69	49E1	68	80HPCH	155
20S434	61	30HPC	155	49E2	69	80HPCHN	155
20S534	61	30HPC	155	49S1114	62	80HPD	153
20S638	61	30HPCH	155	49S318	62	80PPCWS	151
20S738	61	30HPCHN	155	49S434	62	825CWNR	165
20S800	61	30HPD	153	49S638	62	8262MT	233
20S900	61	30HPL	155	49S800	62	826MT	233
20S958	61	30HPLN	155	49S958	62	82CW	149
21155CBP	80	30PPCH	157	4FBRTT	42	82HP	153
21155CBR	80	30PPCHN	157	4SFSCW	138	8302MT	233
21157CBP	80	30PPCWSC	151, 157	4SFSP	139	830MT	233
21157CBR	80	30PPD	157	4SFSP	139	84CW	149
21155CBP	80	30S1114	61	500CW	175	84HP	153
21155CBR	80	30S318	61	500LCD	13	850CW	175
22CW	149	30S434	61	500LCDVR	13	853FCP	232
22HP	153	30S638	61	500P	174	853FCPC	232
22LPCW	149	30S800	61	500P2	174	853FCW	232
22LPH	153	30S958	61	50CW	165	853FCWC	232
22PP	157	3200P2	174	50MCCW	162	853FH	232
22SFSCW	138	3253CL	217	5412CBP	15	853FHC	232
22SFSP	139	3253CT	219	5412CBP	49	85SFVS	166
22SFSP	139	32CC	174	55CWNR	165	86CW	149
23CLRCW	150	32CW	149	5FBRTT	42	86HP	153
23CLRHP	154	32HP	153	60CFC	158	86VS	166
23SL	159	32PP	157	60CW	165	8F	183
23SLB250	159	33CLRCW	150	60CWC	151	8FB434	67
23SLB6250	159	33CLRHP	154	60CWCH	151	8FBNH434	67
23SLINB250	159	34CW	149	60CWCHN	151	8HC258	64, 68
240MPC	16	34HP	153	60CWD	149	8HC414	64
2436UTH	74	34PP	157	60CWGL	151, 155	8HE1	69
2436UTHS	74	350LCD	13	60CWL	151	8HE2	69
24CW	149	35CLRCW	150	60CWLN	151	8HS1114	63
24HP	153	35CLRHP	154	60HPC	155	8HS318	63
24LPCW	149	35CW	165	60HPCH	155	8HS434	63
24LPH	153	36CF	158	60HPCHN	155	8HS638	63
24PP	157	36CW	149	60HPD	153	8HS800	63
2500CT	219	36E1	68	60HPL	155	8HS958	63
250LCD	13	36E2	69	60HPLN	155	8RS8	49
250LCDVR	13	36E4	69	60PPCH	157	8SFSCW	138
25CLRCW	150	36E5	69	60PPCHN	157	8SFSP	139
25CLRHP	154	36HP	153	60PPCWS	151, 157	8SFSP	139
25E1	68	36PP	157	60PPD	157	900CT	219
25E2	69	36S1058	62	62CW	149	900CW	166
25E4	69	36S1114	62	62HP	153	900P	174
		36S1214	62	62PP	157		

ALPHA NUMERICAL LISTING

CODE	PAGE	CODE	PAGE	CODE	PAGE	CODE	PAGE
900P2	174	BAR650PMT	55	CBA184884V5	127	CBU186084V5	127
9011CW	166	BAR650PMT220	55	CBA185464V4	126	CBU213064V4	126
9013CW	166	BAR730	54	CBA185472V4	126	CBU213072V4	126
901CW	166	BAR730CP	54	CBA185484V5	127	CBU213084V5	127
905CW	166	BAR730DS	54	CBA186064V4	126	CBU213664V4	126
909CW	166	BAR730DSCP	54	CBA186072V4	126	CBU213672V4	126
90CWC	151	BAR730DSDX	53	CBA186084V5	127	CBU213684V5	127
90CWCN	151	BAR730DSPM	53	CBA213064V4	126	CBU214264V4	126
90CWD	149	BAR730DSPMT	53	CBA213072V4	126	CBU214272V4	126
90HPC	155	BAR730DSPMT2	53	CBA213084V5	127	CBU214284V5	127
90HPD	153	BAR730DX	53	CBA213664V4	126	CBU214864V4	126
90PPC	157	BAR730PM	53	CBA213672V4	126	CBU214872V4	126
90PPCWSC	151, 157	BAR730PMT	53	CBA213684V5	127	CBU214884V5	127
90PPD	157	BAR730PMT220	53	CBA214264V4	126	CBU215464V4	126
90SPCW	165	BBR480	42	CBA214272V4	126	CBU215472V4	126
9113CP	231	BBR720	42	CBA214284V5	127	CBU215484V5	127
9113CW	231	BC1115SH	82	CBA214864V4	126	CBU216064V4	126
9114CP	231	BC11TC	82	CBA214872V4	126	CBU216072V4	126
9114CW	231	BC225	82	CBA214884V5	127	CBU216084V5	127
911CPC	231	BC2254S	82	CBA215464V4	126	CBU243064V4	126
911CWC	231	BC230	82	CBA215472V4	126	CBU243072V4	126
911VS	166	BC2304S	82	CBA215484V5	127	CBU243084V5	127
912CBP	80	BC235	82	CBA216064V4	126	CBU243664V4	126
913MT	233	BC2354S	82	CBA216072V4	126	CBU243672V4	126
913VS	166	BC330	82	CBA216084V5	127	CBU243684V5	127
915CP	230	BC3304S	82	CBA243064V4	126	CBU244264V4	126
915CW	230	BC331KD	81	CBA243072V4	126	CBU244272V4	126
918MT	233	BC331KDSH	81	CBA243084V5	127	CBU244284V5	127
91VS	166	BC331KDTC	81	CBA243664V4	126	CBU244864V4	126
92615MT	233	BC340KD	81	CBA243672V4	126	CBU244872V4	126
926MT	233	BC340KDP	81	CBA243684V5	127	CBU244884V5	127
92CW	149	BCT1014	229	CBA244264V4	126	CBU245464V4	126
92HP	153	BK60406	34	CBA244272V4	126	CBU245472V4	126
92PP	157	BK60407	34	CBA244284V5	127	CBU245484V5	127
93CW	165	BR258	66, 68	CBA244864V4	126	CBU246064V4	126
94CW	149	BR414	66	CBA244872V4	126	CBU246072V4	126
94HP	153	BR578	66, 240	CBA244884V5	127	CBU246084V5	127
94PP	157	BR712	66	CBA245464V4	126	CC32	161
950CW	175	BSB10	183	CBA245472V4	126	CCP12	185
950P	174	BSB12	183	CBA245484V5	127	COP15	185
950P2	174	BSB18	183	CBA246064V4	126	CCP27	185
95VS	166	BUF48	42	CBA246072V4	126	CCPL12	185
96CW	165	BUF72	42	CBA246084V5	127	CCPL27	185
96SKRC	188	BV6CW	177	CBCC1	128	CD100	73
96SKRD	188	BWB16CW	169	CBCC10	128	CD100H	73
96SKRF	188	BWM10CW	169	CBCC8	128	CD100HB	73
96SKRLC	188	BWP14CW	169	CBDS18H10	127	CD1313	74
96SKRLD	188	BWW10CW	169	CBDS18H6	127	CD1327	74
96SKRLF	188	CA1300	225	CBDS21H10	127	CD1420	74
96SKRLM	188	CA1623	225	CBDS21H6	127	CD160	73
96SKRLP	188	CA2026	225	CBDS24H10	127	CD1826H	72
96SKRML	188	CA2028	225	CBDS24H6	127	CD1826HB	72
96SKRP	188	CA2129	225	CBID6	128	CD1826MTC	35, 73
978SFVS	166	CA2632	225	CBTR30	127	CD1826MTCBH	35, 73
99VS	166	CA2738	225	CBTR36	127	CD1826PDB	72, 160
9CWNR	165	CA2836	225	CBTR362PK	127	CD2020	72
9E1	68	CA3200	225	CBTR42	127	CD2020H	72
9E2	69	CA3244	225	CBTR422PK	127	CD2020HB	72
9RS9	49	CA3247TR	225	CBTR48	127	CD2028	74
9S1114	60	CA3253	225	CBTR482PK	127	CD300	20, 34, 35, 73
9S318	60	CA3343	225	CBTR54	127	CD300H	73
9S434	60	CA3446	225	CBTR542PK	127	CD300HB	73
9S638	60	CA3646	225	CBTR60	127	CD3253EPP	10
9S800	60	CA3748	225	CBTR602PK	127	CD400	20, 21, 27, 73
9S958	60	CA3753	225	CBU183064V4	126	CDR2020	65, 72
9TGS	187	CA3800	225	CBU183072V4	126	CDR2020H	65, 72
ADC33	77	CA3952	225	CBU183084V5	127	CECBE6	71
ADCS	76	CA4300	225	CBU183664V4	126	CECBL	71
BAR540	56	CA4361	225	CBU183672V4	126	CECBL6	71
BAR540DS	56	CB1220	33, 45, 46, 48	CBU183684V5	127	CECBM6	71
BAR54SR	52	CBA183064V4	126	CBU184264V4	126	CECBR6	71
BAR650	56	CBA183072V4	126	CBU184272V4	126	CECCF6	71
BAR650CP	56	CBA183084V5	127	CBU184284V5	127	CECCH6	71
BAR650DS	56	CBA183664V4	126	CBU184864V4	126	CECCL6	71
BAR650DSCP	56	CBA183672V4	126	CBU184872V4	126	CECCM6	71
BAR650DSDX	55	CBA183684V5	127	CBU184884V5	127	CECCO6	71
BAR650DSPM	55	CBA184264V4	126	CBU185464V4	126	CECCP6	71
BAR650DSPMT	55	CBA184272V4	126	CBU185472V4	126	CECCR6	71
BAR650DSPMT2	55	CBA184284V5	127	CBU185484V5	127	CECDC6	71
BAR650DX	55	CBA184864V4	126	CBU186064V4	126	CECFL6	71
BAR650PM	55	CBA184872V4	126	CBU186072V4	126	CECGO6	71

ALPHA NUMERICAL LISTING

CODE	PAGE	CODE	PAGE	CODE	PAGE	CODE	PAGE
CECGR6	71	CMBPTH2	31	CPA244272V4	98	CPHU245467V4	108
CECHB6	71	CMBPTH2HD	31	CPA244284V5PKG	99	CPHU245475S4	108
CECHU6	71	CMBPTHHD	31	CPA244864V4	98	CPHU245475V4	108
CECIC6	71	CMBPTHSP	31	CPA244872V4	98	CPHU246067S4	108
CECIT6	71	CMBPTHSPHD	31	CPA244884V5PKG	99	CPHU246067V4	108
CECIU6	71	CMBR	33	CPA245464V4	98	CPHU246075S4	108
CECMG6	71	CO2632	223	CPA245472V4	98	CPHU246075V4	108
CECMT6	71	CO3200	223	CPA245484V5PKG	99	CPL12	185
CECOF6	71	CO3253	223	CPA246064V4	98	CPL27	185
CECPI6	71	CO3343	223	CPA246072V4	98	CPMCHD	109
CECPO6	71	CO3646	223	CPA246084V5PKG	99	CPMCWB	102
CECRF6	71	CO3753	223	CPA247264V4PKG	98	CPMDB	102
CECRT6	71	CO3800	223	CPA247272V4PKG	98	CPMU183667V4	99
CECRW6	71	CO4300	223	CPA247284V5PKG	99	CPMU183675V4	99
CECSB6	71	CP12	185	CPB1220	41	CPMU184267V4	99
CECSG6	71	CP1210	18	CPCC1	101	CPMU184275V4	99
CECSH6	71			CPCC10	101	CPMU184867V4	99
CECWF6	71	CP1220	15, 18, 20, 21, 23, 45, 48	CPCC8	101	CPMU184875V4	99
CECWI6	71			CPDS14H11	101	CPMU213667V4	99
CECWT6	71	CP15	185	CPDS14H6	101	CPMU213675DDPKG	105
CECWW6	71	CP27	185	CPDS18H11	101	CPMU213675DDPKG	243
CFPFRC10	158	CP3253	10	CPDS18H6	101	CPMU213675V4	99
CFPMRC10	158	CP6040	34	CPDS21H11	101	CPMU214267V4	99
CFPSRC10	158	CP814	18, 45, 48	CPDS21H6	101	CPMU214275V4	99
CFR18	158	CPA182464V4	98	CPDS24H11	101	CPMU214867V4	99
CFRC18	158	CPA182472V4	98	CPDS24H6	101	CPMU214875V4	99
CFRSC18	158	CPA182484V5PKG	99	CPFE14	103	CPMU243667V4	99
CJ80CW	188	CPA183064V4	98	CPFE18	103	CPMU243675V4	99
CL900P	170, 241	CPA183072V4	98	CPFE21	103	CPMU244267V4	99
CL950P	170, 241	CPA183084V5PKG	99	CPFE24	103	CPMU244275V4	99
CLAM8B5	170	CPA183664V4	98	CPFL241	103	CPMU244867SUPKG	103
CLJ6	170, 241	CPA183672V4	98	CPFL242	103	CPMU244867V4	99
CLLT10	170, 241	CPA183684V5PKG	99	CPFL301	103	CPMU244875DRPKG	104
CLLT12	170, 241	CPA184264V4	98	CPFL302	103	CPMU244875DRPKG	242
CLLT6	170, 241	CPA184272V4	98	CPFL361	103	CPMU244875DPDKG	105
CLLT8	170	CPA184284V5PKG	99	CPFL362	103	CPMU244875DPDKG	243
CLNT10	170, 241	CPA184864V4	98	CPFL421	103	CPMU244875V4	99
CLNT12	170, 241	CPA184872V4	98	CPFL422	103	CPMU246075DRPKG	104
CLNT5	170, 241	CPA184884V5PKG	99	CPFL481	103	CPMU246075DRPKG	242
CLNT8	170, 241	CPA185464V4	98	CPFL482	103	CPTR24	104
CLRSB16	240	CPA185472V4	98	CPFL541	103	CPTR30	104
CLRSB9	240	CPA185484V5PKG	99	CPFL542	103	CPTR36	104
CLRSM8B5	240	CPA186064V4	98	CPFL601	103	CPTR362PK	104
CLRWSR36	240	CPA186072V4	98	CPFL602	103	CPTR42	104
CLSB9	241	CPA186084V5PKG	99	CPFL721	103	CPTR422PK	104
CLSM8B5	170, 241	CPA187264V4PKG	98	CPFL722	103	CPTR48	104
CLSRB5	176, 241	CPA187272V4PKG	98	CPFWSC244860	103	CPTR482PK	104
CLSSM8B5	241	CPA187284V5PKG	99	CPH3	41	CPTR54	104
CLST6	170, 241	CPA212464V4	98	CPHU213667S4	108	CPTR542PK	104
CLST9	170, 241	CPA212472V4	98	CPHU213667V4	108	CPTR60	104
CMBH1826LC	33	CPA212484V5PKG	99	CPHU213675S4	108	CPTR602PK	104
CMBH1826TBC	33	CPA213064V4	98	CPHU213675V4	108	CPTR72	104
CMBH1826TSC	33	CPA213072V4	98	CPHU214267S4	108	CPU182464V4	98
CMBHC1826LC	33	CPA213084V5PKG	99	CPHU214267V4	108	CPU182472V4	98
CMBHC1826TBC	33	CPA213664V4	98	CPHU214275S4	108	CPU182484V5PKG	99
CMBHC1826TBF	33	CPA213672V4	98	CPHU214275V4	108	CPU183064V4	98
CMBHC1826TSC	33	CPA213684V5PKG	99	CPHU214867S4	108	CPU183072V4	98
CMBHC1826TSF	33	CPA214264V4	98	CPHU214867V4	108	CPU183084V5PKG	99
CMBP	29	CPA214272V4	98	CPHU214875S4	108	CPU183664V4	98
CMBPH	31	CPA214284V5PKG	99	CPHU214875V4	108	CPU183672V4	98
CMBPH2	31	CPA214864V4	98	CPHU215467S4	108	CPU183684V5PKG	99
CMBPH2HD	31	CPA214872V4	98	CPHU215467V4	108	CPU184264V4	98
CMBPHD	29	CPA214884V5PKG	99	CPHU215475S4	108	CPU184272V4	98
CMBPHHD	31	CPA215464V4	98	CPHU215475V4	108	CPU184284V5PKG	99
CMBPHSP	31	CPA215472V4	98	CPHU216067S4	108	CPU184864V4	98
CMBPHSPHD	31	CPA215484V5PKG	99	CPHU216067V4	108	CPU184872V4	98
CMBPL	29	CPA216064V4	98	CPHU216075S4	108	CPU184884V5PKG	99
CMBPLH	31	CPA216072V4	98	CPHU216075V4	108	CPU185464V4	98
CMBPLH2	31	CPA216084V5PKG	99	CPHU243667S4	108	CPU185472V4	98
CMBPLH2HD	31	CPA217264V4PKG	98	CPHU243667V4	108	CPU185484V5PKG	99
CMBPLHD	29	CPA217272V4PKG	98	CPHU243675S4	108	CPU186064V4	98
CMBPLHHD	31	CPA217284V5PKG	99	CPHU243675V4	108	CPU186072V4	98
CMBPLHSP	31	CPA242464V4	98	CPHU244267S4	108	CPU186084V5PKG	99
CMBPLHSPHD	31	CPA242472V4	98	CPHU244267V4	108	CPU187264V4PKG	98
CMBPLSP	29	CPA242484V5PKG	99	CPHU244275S4	108	CPU187272V4PKG	98
CMBPLSPHD	29	CPA243064V4	98	CPHU244275V4	108	CPU187284V5PKG	99
CMBPR1	29	CPA243072V4	98	CPHU244867S4	108	CPU212464V4	98
CMBPR7	29	CPA243084V5PKG	99	CPHU244867V4	108	CPU212472V4	98
CMBPSP	29	CPA243664V4	98	CPHU244875S4	108	CPU212484V5PKG	99
CMBPSPHD	29	CPA243672V4	98	CPHU244875V4	108	CPU213064V4	98
CMBPTH	31	CPA243684V5PKG	99	CPHU245467S4	108	CPU213072V4	98
		CPA244264V4	98				

ALPHA NUMERICAL LISTING

CODE	PAGE	CODE	PAGE	CODE	PAGE	CODE	PAGE
CPU213084V5PKG	99	CVC55	47	EA214864V4	114	EMU243678V4	115
CPU213664V4	98	CVC72	47	EA214872V4	114	EMU244270V4	115
CPU213672V4	98	CVC724	47	EA214884V5	115	EMU244278V4	115
CPU213684V5PKG	99	D12	173	EA215464V4	114	EMU244870V4	115
CPU214264V4	98	D14	173	EA215472V4	114	EMU244878DRPKG	242
CPU214272V4	98	D16	173	EA215484V5	115	EMU244878PDPKG	121
CPU214284V5PKG	99	D24	173	EA216064V4	114	EMU244878V4	115
CPU214864V4	98	D8	173	EA216072V4	114	EMU245470V4	115
CPU214872V4	98	DB18263CW	160	EA216084V5	115	EMU245478V4	115
CPU214884V5PKG	99	DB18263P	160	EA217264V4	114	EMU246070V4	115
CPU215464V4	98	DB18266CW	160	EA217272V4	114	EMU246078DRPKG	121, 242
CPU215472V4	98	DBC1826CW	160	EA217284V5	115	EMU246078V4	115
CPU215484V5PKG	99	DBC1826P	160	EA242464V4	114	EPP160	10
CPU216064V4	98	DC10	179	EA242472V4	114	EPP180	10
CPU216072V4	98	DC1225	79	EA242484V5	115	EPP180PKG	10
CPU216084V5PKG	99	DC5	179	EA243064V4	114	EPP180S	10
CPU217264V4PKG	98	DC575	79	EA243072V4	114	EPP180SPKG	10
CPU217272V4PKG	98	DC700	79	EA243084V5	115	EPP300	10
CPU217284V5PKG	99	DC825	79	EA243664V4	114	EPP3253DIV	10
CPU242464V4	98	DCC10	179	EA243672V4	114	EPP400	10
CPU242472V4	98	DCC5	179	EA243684V5	115	EPPID5	10
CPU242484V5PKG	99	DCS1125	79	EA244264V4	114	ES28	46
CPU243064V4	98	DCS950	79	EA244272V4	114	ES28RL	46
CPU243072V4	98	DD1220BECW	184	EA244284V5	115	ESU182464V4	114
CPU243084V5PKG	99	DD1220CW	184	EA244864V4	114	ESU182472V4	114
CPU243664V4	98	DD1220ECW	184	EA244872V4	114	ESU182484V5	115
CPU243672V4	98	DD1220SCW	184	EA244884V5	115	ESU183064V4	114
CPU243684V5PKG	99	DD1826CW	184	EA245464V4	114	ESU183072V4	114
CPU244264V4	98	DG3CW	169	EA245472V4	114	ESU183084V5	115
CPU244272V4	98	DIV12	17, 41, 48	EA245484V5	115	ESU183664V4	114
CPU244284V5PKG	99	DIV20	17, 41	EA246064V4	114	ESU183672V4	114
CPU244864SUPKG	103	DP15	179	EA246072V4	114	ESU183684V5	115
CPU244864V4	98	DRC2020	65, 240	EA246084V5	115	ESU184264V4	114
CPU244872V4	98	DRLNK	131	EA247264V4	114	ESU184272V4	114
CPU244884V5PKG	99	DRS30	131	EA247272V4	114	ESU184284V5	115
CPU245464V4	98	DRS300	131	EA247284V5	115	ESU184864V4	114
CPU245472V4	98	DRS36	131	ECC1	117	ESU184872V4	114
CPU245484V5PKG	99	DRS360	131	ECC10	117	ESU184884V5	115
CPU246064V4	98	DRS48	131	ECC8	117	ESU185464V4	114
CPU246072V4	98	DRS480	131	EDBA	119	ESU185472V4	114
CPU246084V5PKG	99	DRS60	131	EDBS	119	ESU185484V5	115
CPU247264V4PKG	98	DRS600	131	EDS14H10	117	ESU186064V4	114
CPU247272V4PKG	98	DSPR6	176	EDS14H6	117	ESU186072V4	114
CPU247284V5PKG	99	DT1220CW	184	EDS18H10	117	ESU186084V5	115
CR12	75	E3	69, 240	EDS18H6	117	ESU187264V4	114
CRPHDG2878	66, 240	EA182464V4	114	EDS21H10	117	ESU187272V4	114
CSDBA	102	EA182472V4	114	EDS21H6	117	ESU187284V5	115
CSDBS	102	EA182484V5	115	EDS24H10	117	ESU212464V4	114
CSDDC	105, 120, 129, 243	EA183064V4	114	EDS24H6	117	ESU212472V4	114
CSDDC5	105, 120, 129, 243	EA183072V4	114	EMCWB	118	ESU212484V5	115
CSDR7	104, 121, 129, 242	EA183084V5	115	EMTR36	120	ESU213064V4	114
CSDR73	104, 121, 129, 242	EA183664V4	114	EMTR362PK	120	ESU213072V4	114
CSDR8	105, 121, 129, 243	EA183672V4	114	EMTR42	120	ESU213084V5	115
CSDR84	105, 121, 129, 243	EA183684V5	115	EMTR422PK	120	ESU213664V4	114
CSEQ3	102, 118, 128	EA184264V4	114	EMTR48	120	ESU213672V4	114
CSHDF	109	EA184272V4	114	EMTR482PK	120	ESU213684V5	115
CSID3	101, 118	EA184284V5	115	EMTR54	120	ESU214264V4	114
CSID6	101, 118	EA184864V4	114	EMTR542PK	120	ESU214272V4	114
CSMHDDDB	119	EA184872V4	114	EMTR60	120	ESU214284V5	115
CSMHDTK10	109	EA184884V5	115	EMTR602PK	120	ESU214864V4	114
CSMHDTK12	109	EA185464V4	114	EMU183670V4	115	ESU214872V4	114
CSMHDTK145	109	EA185472V4	114	EMU183678V4	115	ESU214884V5	115
CSMHDTKE4	109	EA185484V5	115	EMU184270V4	115	ESU215464V4	114
CSMHDTKE5	109	EA186064V4	114	EMU184278V4	115	ESU215472V4	114
CSMHDTKE6	109	EA186072V4	114	EMU184870V4	115	ESU215484V5	115
CSR3	13	EA186084V5	115	EMU184878V4	115	ESU216064V4	114
CSR5	13	EA187264V4	114	EMU185470V4	115	ESU216072V4	114
CSSC244818	104, 120, 129	EA187272V4	114	EMU185478V4	115	ESU216084V5	115
CSSD188	102, 119, 128	EA187284V5	115	EMU186070V4	115	ESU217264V4	114
CSSD218	102, 119, 128	EA212464V4	114	EMU186078V4	115	ESU217272V4	114
CSSD248	102, 119, 128	EA212472V4	114	EMU213670V4	115	ESU217284V5	115
CSTR	103, 119, 129	EA212484V5	115	EMU213678V4	115	ESU242464V4	114
CSWF	101, 118, 128	EA213064V4	114	EMU214270V4	115	ESU242472V4	114
CSWS1436SK	130	EA213072V4	114	EMU214278V4	115	ESU242484V5	115
CSWS1436VK	130	EA213084V5	115	EMU214870V4	115	ESU243064V4	114
CSWS1448SK	130	EA213664V4	114	EMU214878V4	115	ESU243072V4	114
CSWS1448VK	130	EA213672V4	114	EMU215470V4	115	ESU243084V5	115
CSWS1836SK	130	EA213684V5	115	EMU215478V4	115	ESU243664V4	114
CSWS1848SK	130	EA214264V4	114	EMU216070V4	115	ESU243672V4	114
CSWS36EK	130	EA214272V4	114	EMU216078V4	115	ESU243684V5	115
CSWS48EK	130	EA214284V5	115	EMU243670V4	115	ESU244264V4	114

ALPHA NUMERICAL LISTING

CODE	PAGE	CODE	PAGE	CODE	PAGE	CODE	PAGE
ESU244272V4	114	GP55702	205	LT6	173	NT14	172
ESU244284V5	115	GP55703	205	LT8	173	NT16	172
ESU244864V4	114	GPE0540	199	MA2435	227	NT20	172
ESU244872V4	114	GPE3980	199	MA3142H	227	NT5	172
ESU244884V5	115	GPE4002	199	MA3200	227	NT8	172
ESU245464V4	114	GPE4004	199	MA3343	227	NT9	172
ESU245472V4	114	HBR258	66, 68	MA3646	227	OETR314	67
ESU245484V5	115	HBR414	66	MA3652TR	227	P320CW	168
ESU246064V4	114	HBR578	66	MA3800	227	P34CW	168
ESU246072V4	114	HBR712	66	MA4300	227	P34LCW	168
ESU246084V5	115	HE3	69	MA4361	227	P480CW	168
ESU247264V4	114	HFR258	67	MDC1411T60	254	P600CW	168
ESU247272V4	114	HK39	165	MDC1418S20	252	P60CW	168
ESU247284V5	115	HK39B	239	MDC1418T16	253	P64CW	168
ETR24	120	HK93BCW	165	MDC1418T30	253	PC34CW	168
ETR30	120	HK93CW	165	MDC1520S10	251	PC64CW	168
ETR36	120	HP3253	10	MDC1520S10HD	251	PE600CW	168
ETR362PK	120	HT10CW	172	MDC1520S20	252	PH556010	221
ETR42	120	HT120CW	172	MDC1520T16	253	PH556016	221
ETR422PK	120	HT12CW	172	MDC1520T30	253	PH556020	221
ETR48	120	HT14CW	172	MDC24	15	PH556026	221
ETR482PK	120	HT16CW	172	MDC24F	15	PH556030	221
ETR54	120	HT22CW	172	MDC24R	15	PH556036	221
ETR542PK	120	HT5CW	172	MDSB16	239	PH556040	221
ETR60	120	HT8CW	172	MDSB5	239	PH556046	221
ETR602PK	120	HWAPR	14	MDSB9	239	PH556050	221
ETR72	120	HWATD	14	MDS9	239	PH556056	221
FPID24	156	HYDRASTATIONPKG	14	MDSL9	239	PH556510	221
FR258	67	IB32	161	MDSL9	239	PH556516	221
FSG480	42	IB36	161	MDSM8	239	PH556520	221
FSG720	42	IB44	161	MDSP9	239	PH556526	221
FWC56	67	IBS20	161	MDSPL	239	PH557010	221
FWC56	75	IBS27	161	MDSPLT9	239	PH557016	221
GB1200CW	169	IBSF7	161	MPHU51017S4PKG	109	PH557020	221
GB850CW	169	IBSF27	161	MPHU51017V4PKG	109	PH557026	221
GK2000	64	ICS100L	57	MPHU51117S4PKG	109	PH557030	221
GL0540	206	ICS100L4S	57	MPHU51117V4PKG	109	PH557036	221
GL1070	206	ICS125L	57	MPHU51217S4PKG	109	PH557040	221
GL1070RNS	210	ICS125LB	57	MPHU51217V4PKG	109	PH557046	221
GL1080	206	ICS125T	57	MPHU51317S4PKG	109	PH558510	221
GL210P	207	ICS175L	57	MPHU51317V4PKG	109	PH558516	221
GL220P	207	ICS175LB	57	MPHU5917S4PKG	109	PH558520	221
GL3074	206	ICS175T	57	MPHU5917V4PKG	109	PH558526	221
GL3980	206	ICS175TB	57	MPHU61017S4PKG	109	PH558530	221
GL3980NS	209, 248	ICS200TB	57	MPHU61017V4PKG	109	PH558536	221
GL3980RNS	210	IT3253	36	MPHU61117S4PKG	109	PL60CW	168
GL4002	206	IT3253	245	MPHU61117V4PKG	109	PPB15	177
GL4002NS	209, 248	IT3753T	36	MPHU61217S4PKG	109	PPB18	177
GL4002RNS	210	IT3753T	245	MPHU61217V4PKG	109	PPB23	177
GL4060	34, 206	ITPD3253	36	MPHU61317S4PKG	109	PR314	67
GL4210	206	ITPD3253	245	MPHU61317V4PKG	109	PR500	67
GL4701	206	ITPD3753T	36	MPHU6917S4PKG	109	PR500	240
GL4709	206	ITPD3753T	245	MPHU6917V4PKG	109	PR59314	67
GP0540 (Group 3)	202	KK1200	64	MPMCHD	109	PR59500	67
GP0540	205	KSC402	46	MPMU61117DRPKG	242	PS1014	229
GP0540NS (Group 3)	203, 247	KVC854	45	MPMU61217PDPKG	243	PSB10	181
GP1070	200, 205	KVC854C	45	MPMU61317DRPKG	242	PSB12	181
GP1070AB	201, 246	KVC856	45	MW2129	222	PSB15	182
GP1080	205	KVC856C	45	MW3200	222	PSB18	182
GP1080AB	201, 246	KWS40	46	MW3245	222	PSB23	182
GP1080NS (Group 3)	203, 247	LCDC	14	MW3600	222	PSB6	181
GP3074	205	LCDC	14	MW3646	222	PSB8	181
GP3788	205	LCDC	14	MW3858	222	PT1014	220
GP3980	200, 205	LD105	185	MW4200	222	PT1100	220
GP3980 (Group 3)	202	LD105A	185	MY2026	226	PT1216	220
GP3980AB	201, 246	LD130	185	MY2129	226	PT1400	220
GP3980NS (Group 3)	203, 247	LD85	185	MY2632	226	PT1418	220
GP4002	200, 205	LD85A	185	MY2738	226	PT1600	220
GP4002 (Group 3)	202	LDT10	170	MY3200	226	PWB22	14
GP4002AB	201, 246	LDT12	170	MY3244	226	PWB22	176
GP4002NS (Group 3)	203, 247	LDT16	170	MY3253	226	R1000LCD	14
GP4004	200	LDT22	170	MY3343	226	R500LCD	14
GP4004 (Group 3)	202	LDT5	170	MY3446	226	RD1200CW	184
GP4004	205	LDT6	170, 241	MY3646	226	RD1220CW	184
GP4210	205	LDT9	170, 241	MY3753	226	RD1220CWH	184
GP4410	205	LED54LIGHTPKG	41	MY3800	226	RD1826CW	184
GP4701	205	LT10	173	MY3952	226	RD1826CWH	184
GP4709	205	LT12	173	MY4300	226	RD926CW	184
GP4853	205	LT14	173	MY4361	226	RFS1	143
GP4856	205	LT16	173	NT10	172	RFS12	143
GP55653	205	LT22	173	NT12	172	RFS12PP	143

ALPHA NUMERICAL LISTING

CODE	PAGE	CODE	PAGE	CODE	PAGE
RFS12SCPP	142	SPOP11CW	186	VBRTD5	40
RFS18	143	SPOP13	186	VBRTD6	40
RFS18PP	143	SPOP13CW	186	VBRTL5	40
RFS1PP	143	SRB13	176	VBRTL6	40
RFS1SCPP	142	SRB13CW	176	VBRTLHD5	40
RFS2	143	SRB5	176	VBRTLHD6	40
RFS22	143	SRB5CW	176	VBRU5	40
RFS22PP	143	TC1418	75	VBRU6	40
RFS2PP	143	TDC2029	75	VBRUHD5	40
RFS2SCPP	142	TDC30	79	VBRUHD6	40
RFS4	143	TDCR12	75	VBRUT5	40
RFS4PP	143	TG6	187	VBRUT6	40
RFS6	143	TG9	187	VBRUTH5	40
RFS6PP	143	TGA11	187	VBRUTHD6	40
RFS6SCPP	142	TGA8	187	VBRWC	41
RFS8	143	TGG6	187	VCS	40
RFS8PP	143	TGG9	187	VCS32CNT	40
RFSC1	143	UC1000	13	VCS32KEYT	41
RFSC12	143	UC1000CVR	13	VCS32R	41
RFSC12	176	UC250	13	VCSCNL	40
RFSC12PP	143	UC250CVR	13	VCSCVR	41
RFSC1PP	143	UC500	13	VCSHD	40
RFSC2	143	UC500CVR	13	VCSWR	40
RFSC2PP	143	UPC100	17	VCSWRHD	40
RFSC6	143	UPC1200	23	VL1014	207
RFSC6PP	143	UPC140	17	VL1216	207
RFSCW1	142	UPC160	17	VL1418	207, 208
RFSCW12	142	UPC1600	23	VL1418NS	209, 248
RFSCW18	142	UPC1600HD	23	VL1418RNS	210
RFSCW2	142	UPC1600SP	23	VL2129RNS	210
RFSCW22	142	UPC180	17	VL2632	207
RFSCW4	142	UPC400	20	VL3200RNS	210
RFSCW6	142	UPC400SP	20	VL3253	207
RFSCW8	142	UPC600	23	VL3343	207
RFSCWC1	142	UPC800	23	VL3343C	207
RFSCWC12	142	UPC800SP	23	VL3343CNS	209, 248
RFSCWC2	142	UPCGL1600SP	23	VL3343NS	209, 248
RFSCWC6	142	UPCH1600	27	VL3600RNS	210
RSB1014CW	182	UPCH16002	27	VL3646C	207, 208
RSB10CW	182	UPCH16002HD	27	VL3646CNS	209, 248
RSB12CW	182	UPCH16002SP	27	VL3753	207
RSB1419CW	182	UPCH1600HD	27	VT1216	204
RSB15CW	182	UPCH1600SP	27	VT1418	200, 204, 208
RSB18CW	182	UPCH400	27	VT1418AB	201
RSB23CW	182	UPCH4002	27	VT1418AB	246
RSB6CW	182	UPCH800	27	VT1418TR	204
RSB8CW	182	UPCH8002	27	VT1520	204
RSB912CW	182	UPCHT1600	27	VT2632	200, 204
SB55	183	UPCHT16002	27	VT3253	200, 204
SB60	183	UPCHT16002HD	27	VT3343	200, 204
SB80	183	UPCHT1600HD	27	VT3343AB	201, 246
SBH15	41	UPCHT800	27	VT3343C	204
SBH18	41	UPCHT8002	27	VT3343CAB	201, 246
SCP12CW	162	UPCHW400	27	VT3646C	200, 204, 208
SCP24CW	162	UPCHW4002	27	VT3646CAB	201, 246
SCP64CW	162	UPCS140	17	VT3753	200, 204
SCP6CW	162	UPCS160	17	VT3853	204
SFC12	139	UPCS180	17	VTE1418	199
SFC12SCPP	138	UPCS400	21	VTE3253	199
SFC2	139	UPCS400CK	21	VTE3343	199
SFC2SCPP	138	UPCSS160	17	VTE3646C	199
SFC6	139	VBR5	40	VTE3753	199
SFC6SCPP	138	VBR6	40	WC100CW	177
SFG1012	180	VBRC	40	WC100CWNH	177
SFG1015	180	VBRC90	40	WCR1220	45
SFG1220	180	VBRCVR5	41	WCR1220	48
SFG820	180	VBRCVR6	41	WR60406	34
SFR1012	180	VBRHD5	40	WR60407	34
SFT1010	180	VBRHD6	40	WW1000	175
SFT1212	180	VBRL5	40	WW1000L	175
SFT1515	180	VBRL6	40	WW1000LS	175
SFV1015	180	VBRLHD5	40	WW1500	175
SLL30	159	VBRLHD6	40	WW250	175
SPA14	186	VBRR5	41	WW250L	175
SPASL14	186	VBRR6	41	WW500	175
SPO10CW	186	VBRSHTS	41		
SPO11CW	186	VBRT5	40		
SPO13	186	VBRT6	40		
SPO13CW	186	VBRTBL	41		
SPO8CW	186	VBRTCVR5	41		
SPOP10CW	186	VBRTCVR6	41		

Cambro Warranty

Cambro Camtrays® and Camwear® Dinnerware have a five year guarantee against breakage. Camtherm Bulk Food Holding Cabinets hold a one-year warranty. Polycarbonate food storage products are guaranteed for two years under normal usage. Camshelving® has a one-year warranty on workmanship and a lifetime limited warranty against rust and corrosion, excluding mobile posts. For all other Cambro products, Cambro warrants to the original buyer a three-year pro-rated guarantee. If product proves defective during this time, Cambro grants a pro-rated credit of the original price toward replacement product. The warranty applies on all Cambro products only when used under normal foodservice industry conditions.

Photo credits:

Cambro products help foodservice operators throughout the world. To represent our global presence, images of Cambro products in use have been taken on locations throughout southern California, USA; in Cancun, Mexico; on the island of Rugen, Germany; and in the city of Huizhou, China. In particular, special thanks to the staffs of the Ambience Hotel, Rugen; Jin Hua Palace Hotel, Huizhou; Southern California Gas Company, Downey; Orange Coast College, Santa Ana and California Hospital, Los Angeles for their assistance in our photo shoots.

CAMSHELVING® CODE CONVERSION LIST

OLD CODE	NEW CODE	PAGE	OLD CODE	NEW CODE	PAGE	OLD CODE	NEW CODE	PAGE
CBA183672	CBA183672V4	126	CSDBA	CSDBA	102	CSU48547	CPU185472V4	98
CBA184272	CBA184272V4	126	CSDBS	CSDBS	102	CSU48606	CPU186064V4	98
CBA184872	CBA184872V4	126	CSDR7	CSDR7	104,121,129,242	CSU48607	CPU186072V4	98
CBA185472	CBA185472V4	126	CSDR73	CSDR73	104,121,129,242	CSU54368PKG	CPU243684V5PKG	99
CBA186072	CBA186072V4	126	CSDR244875PKG	CPMU244875DRPKG	104,242	CSU54428PKG	CPU244284V5PKG	99
CBA213672	CBA213672V4	126	CSDR246075PKG	CPMU246075DRPKG	104,242	CSU54488PKG	CPU244884V5PKG	99
CBA214272	CBA214272V4	126	CSDS14	CPDS14H6	101	CSU54548PKG	CPU245484V5PKG	99
CBA214872	CBA214872V4	126	CSDS18	CPDS18H6	101	CSU54608PKG	CPU246084V5PKG	99
CBA215472	CBA215472V4	126	CSDS21	CPDS21H6	101	CSUHD44367	CPHU243675V4	108
CBA216072	CBA216072V4	126	CSDS24	CPDS24H6	101	CSUHD44367S	CPHU243675S4	108
CBA243672	CBA243672V4	126	CSEQ3	CSEQ3	102,118,128	CSUHD44427	CPHU244275V4	108
CBA244272	CBA244272V4	126	CSFE14	CPFE14	103	CSUHD44427S	CPHU244275S4	108
CBA244872	CBA244872V4	126	CSFE18	CPFE18	103	CSUHD44486	CPHU244867V4	108
CBA245472	CBA245472V4	126	CSFE21	CPFE21	103	CSUHD44486S	CPHU244867S4	108
CBA246072	CBA246072V4	126	CSFE24	CPFE24	103	CSUHD44487	CPHU244875V4	108
CBCC	CBCC1	128	CSFT241	CPFL241	103	CSUHD44487S	CPHU244875S4	108
CBDS18	CBDS18H6	127	CSFT242	CPFL242	103	CSUR41366	CPMU213667V4	99
CBDS21	CBDS21H6	127	CSFT301	CPFL301	103	CSUR41367	CPMU213675V4	99
CBDS24	CBDS24H6	127	CSFT302	CPFL302	103	CSUR41426	CPMU214267V4	99
CBID6	CBID6	128	CSFT361	CPFL361	103	CSUR41427	CPMU214275V4	99
CBU183672	CBU183672V4	126	CSFT362	CPFL362	103	CSUR41486	CPMU214867V4	99
CBU184272	CBU184272V4	126	CSFT421	CPFL421	103	CSUR41487	CPMU214875V4	99
CBU184872	CBU184872V4	126	CSFT422	CPFL422	103	CSUR44366	CPMU243667V4	99
CBU185472	CBU185472V4	126	CSFT481	CPFL481	103	CSUR44367	CPMU243675V4	99
CBU186072	CBU186072V4	126	CSFT482	CPFL482	103	CSUR44426	CPMU244267V4	99
CBU213672	CBU213672V4	126	CSFT541	CPFL541	103	CSUR44427	CPMU244275V4	99
CBU214272	CBU214272V4	126	CSFT542	CPFL542	103	CSUR44486	CPMU244867V4	99
CBU214872	CBU214872V4	126	CSFT601	CPFL601	103	CSUR44487	CPMU244875V4	99
CBU215472	CBU215472V4	126	CSFT602	CPFL602	103	CSUR48366	CPMU183667V4	99
CBU216072	CBU216072V4	126	CSFT721	CPFL721	103	CSUR48367	CPMU183675V4	99
CBU243672	CBU243672V4	126	CSFT722	CPFL722	103	CSUR48426	CPMU184267V4	99
CBU244272	CBU244272V4	126	CSHDC	CPMCHD	109	CSUR48427	CPMU184275V4	99
CBU244872	CBU244872V4	126	CSHDD	CPMHDD	119	CSUR48486	CPMU184867V4	99
CBU245472	CBU245472V4	126	CSHDF	CPMHDF	109	CSUR48487	CPMU184875V4	99
CBU246072	CBU246072V4	126	CSHDTK10	CPMHDTK10	109	CSWF	CSWF	101,118,128
CSA41366	CPA213664V4	98	CSHDTK12	CPMHDTK12	109	CSWS1436SK	CSWS1436SK	130
CSA41367	CPA213672V4	98	CSHDTK145	CPMHDTK145	109	CSWS1436VK	CSWS1436VK	130
CSA41426	CPA214264V4	98	CSID	CSID6	101,118	CSWS1448SK	CSWS1448SK	130
CSA41427	CPA214272V4	98	CSID3	CSID3	101,118	CSWS1448VK	CSWS1448VK	130
CSA41486	CPA214864V4	98	CSRDB	CPMDB	102	CSWS1836SK	CSWS1836SK	130
CSA41487	CPA214872V4	98	CSSC2448	CSSC244818	104,120,129	CSWS1848SK	CSWS1848SK	130
CSA41546	CPA215464V4	98	CSSU2448000	CPFWSC244860	103	CSWS36EK	CSWS36EK	130
CSA41547	CPA215472V4	98	CSSU244864PKG	CPU244864SUPKG	103	CSWS48EK	CSWS48EK	130
CSA41606	CPA216064V4	98	CSSUM244867PKG	CPMU244867SUPKG	103	EAI83664	EAI83664V4	114
CSA41607	CPA216072V4	98	CSTSR	CSTSR	103,119,129	EAI83672	EAI83672V4	114
CSA44366	CPA243664V4	98	CSU41366	CPU213664V4	98	EAI84264	EAI84264V4	114
CSA44367	CPA243672V4	98	CSU41367	CPU213672V4	98	EAI84272	EAI84272V4	114
CSA44426	CPA244264V4	98	CSU41426	CPU214264V4	98	EAI84864	EAI84864V4	114
CSA44427	CPA244272V4	98	CSU41427	CPU214272V4	98	EAI84872	EAI84872V4	114
CSA44486	CPA244864V4	98	CSU41486	CPU214864V4	98	EAI85464	EAI85464V4	114
CSA44487	CPA244872V4	98	CSU41487	CPU214872V4	98	EAI85472	EAI85472V4	114
CSA44546	CPA245464V4	98	CSU41546	CPU215464V4	98	EAI86064	EAI86064V4	114
CSA44547	CPA245472V4	98	CSU41547	CPU215472V4	98	EAI86072	EAI86072V4	114
CSA44606	CPA246064V4	98	CSU41606	CPU216064V4	98	EA213664	EA213664V4	114
CSA44607	CPA246072V4	98	CSU41607	CPU216072V4	98	EA213672	EA213672V4	114
CSA48366	CPA183664V4	98	CSU44366	CPU243664V4	98	EA214264	EA214264V4	114
CSA48367	CPA183672V4	98	CSU44367	CPU243672V4	98	EA214272	EA214272V4	114
CSA48426	CPA184264V4	98	CSU44426	CPU244264V4	98	EA214864	EA214864V4	114
CSA48427	CPA184272V4	98	CSU44427	CPU244272V4	98	EA214872	EA214872V4	114
CSA48486	CPA184864V4	98	CSU44486	CPU244864V4	98	EA215464	EA215464V4	114
CSA48487	CPA184872V4	98	CSU44487	CPU244872V4	98	EA215472	EA215472V4	114
CSA48546	CPA185464V4	98	CSU44546	CPU245464V4	98	EA216064	EA216064V4	114
CSA48547	CPA185472V4	98	CSU44547	CPU245472V4	98	EA216072	EA216072V4	114
CSA48606	CPA186064V4	98	CSU44606	CPU246064V4	98	EA243664	EA243664V4	114
CSA48607	CPA186072V4	98	CSU44607	CPU246072V4	98	EA243672	EA243672V4	114
CSA54368PKG	CPA243684V5PKG	99	CSU48366	CPU183664V4	98	EA244264	EA244264V4	114
CSA54428PKG	CPA244284V5PKG	99	CSU48367	CPU183672V4	98	EA244272	EA244272V4	114
CSA54488PKG	CPA244884V5PKG	99	CSU48426	CPU184264V4	98	EA244864	EA244864V4	114
CSA54548PKG	CPA245484V5PKG	99	CSU48427	CPU184272V4	98	EA244872	EA244872V4	114
CSA54608PKG	CPA246084V5PKG	99	CSU48486	CPU184864V4	98	EA245464	EA245464V4	114
CSCC	CPCC1	101	CSU48487	CPU184872V4	98	EA245472	EA245472V4	114
CSCTL	CPMCWB	102	CSU48546	CPU185464V4	98	EA246064	EA246064V4	114

CAMSHELVING® CODE CONVERSION LIST

OLD CODE	NEW CODE	PAGE	OLD CODE	NEW CODE	PAGE	OLD CODE	NEW CODE	PAGE
EA246072	EA246072V4	114	New	CBA186064V4	126	New	CBU243084V5	127
ECC	ECC1	117	New	CBA186084V5	127	New	CBU243664V4	126
EDBA	EDBA	119	New	CBA213064V4	126	New	CBU243684V5	127
EDBS	EDBS	119	New	CBA213072V4	126	New	CBU244264V4	126
EDRC244878PKG	EMU244878DRPKG	121	New	CBA213084V5	127	New	CBU244284V5	127
EDRC246078PKG	EMU246078DRPKG	121	New	CBA213664V4	126	New	CBU244864V4	126
EDS14	EDS14H6	117	New	CBA213684V5	127	New	CBU244884V5	127
EDS18	EDS18H6	117	New	CBA214264V4	126	New	CBU245464V4	126
EDS21	EDS21H6	117	New	CBA214284V5	127	New	CBU245484V5	127
EDS24	EDS24H6	117	New	CBA214864V4	126	New	CBU246064V4	126
EMSCBP	EMCWB	118	New	CBA214884V5	127	New	CBU246084V5	127
EMU183670P	EMU183670V4	115	New	CBA215464V4	126	New	CPA182464V4	98
EMU183678P	EMU183678V4	115	New	CBA215484V5	127	New	CPA182472V4	98
EMU184270P	EMU184270V4	115	New	CBA216064V4	126	New	CPA182484V5PKG	99
EMU184278P	EMU184278V4	115	New	CBA216084V5	127	New	CPA183064V4	98
EMU184870P	EMU184870V4	115	New	CBA243064V4	126	New	CPA183072V4	98
EMU184878P	EMU184878V4	115	New	CBA243072V4	126	New	CPA183084V5PKG	99
EMU213670P	EMU213670V4	115	New	CBA243084V5	127	New	CPA183684V5PKG	99
EMU213678P	EMU213678V4	115	New	CBA243664V4	126	New	CPA184284V5PKG	99
EMU214270P	EMU214270V4	115	New	CBA243684V5	127	New	CPA184884V5PKG	99
EMU214278P	EMU214278V4	115	New	CBA244264V4	126	New	CPA185484V5PKG	99
EMU214870P	EMU214870V4	115	New	CBA244284V5	127	New	CPA186084V5PKG	99
EMU214878P	EMU214878V4	115	New	CBA244864V4	126	New	CPA187264V4PKG	98
EMU243670P	EMU243670V4	115	New	CBA244884V5	127	New	CPA187272V4PKG	98
EMU243678P	EMU243678V4	115	New	CBA245464V4	126	New	CPA187284V5PKG	99
EMU244270P	EMU244270V4	115	New	CBA245484V5	127	New	CPA212464V4	98
EMU244278P	EMU244278V4	115	New	CBA246064V4	126	New	CPA212472V4	98
EMU244870P	EMU244870V4	115	New	CBA246084V5	127	New	CPA212484V5PKG	99
EMU244878DRPKG	EMU244878DRPKG	242	New	CBCC10	128	New	CPA213064V4	98
EMU244878P	EMU244878V4	115	New	CBCC8	128	New	CPA213072V4	98
EMU246078DRPKG	EMU246078DRPKG	242	New	CBDS18H12	127	New	CPA213084V5PKG	99
ESU183664	ESU183664V4	114	New	CBDS21H12	127	New	CPA213684V5PKG	99
ESU183672	ESU183672V4	114	New	CBDS24H12	127	New	CPA214284V5PKG	99
ESU184264	ESU184264V4	114	New	CBTR30	127	New	CPA214884V5PKG	99
ESU184272	ESU184272V4	114	New	CBTR36	127	New	CPA215484V5PKG	99
ESU184864	ESU184864V4	114	New	CBTR362PK	127	New	CPA216084V5PKG	99
ESU184872	ESU184872V4	114	New	CBTR42	127	New	CPA217264V4PKG	98
ESU185464	ESU185464V4	114	New	CBTR422PK	127	New	CPA217272V4PKG	98
ESU185472	ESU185472V4	114	New	CBTR48	127	New	CPA217284V5PKG	99
ESU186064	ESU186064V4	114	New	CBTR482PK	127	New	CPA242464V4	98
ESU186072	ESU186072V4	114	New	CBTR54	127	New	CPA242472V4	98
ESU213664	ESU213664V4	114	New	CBTR542PK	127	New	CPA242484V5PKG	99
ESU213672	ESU213672V4	114	New	CBTR60	127	New	CPA243064V4	98
ESU214264	ESU214264V4	114	New	CBTR602PK	127	New	CPA243072V4	98
ESU214272	ESU214272V4	114	New	CBU183064V4	126	New	CPA243084V5PKG	99
ESU214864	ESU214864V4	114	New	CBU183072V4	126	New	CPA247264V4PKG	98
ESU214872	ESU214872V4	114	New	CBU183084V5	127	New	CPA247272V4PKG	98
ESU215464	ESU215464V4	114	New	CBU183664V4	126	New	CPA247284V5PKG	99
ESU215472	ESU215472V4	114	New	CBU183684V5	127	New	CPCC10	101
ESU216064	ESU216064V4	114	New	CBU184264V4	126	New	CPCC8	101
ESU216072	ESU216072V4	114	New	CBU184284V5	127	New	CPDS14H12	101
ESU243664	ESU243664V4	114	New	CBU184864V4	126	New	CPDS18H12	101
ESU243672	ESU243672V4	114	New	CBU184884V5	127	New	CPDS21H12	101
ESU244264	ESU244264V4	114	New	CBU185464V4	126	New	CPDS24H12	101
ESU244272	ESU244272V4	114	New	CBU185484V5	127	New	CPHU213667S4	108
ESU244864	ESU244864V4	114	New	CBU186064V4	126	New	CPHU213667V4	108
ESU244872	ESU244872V4	114	New	CBU186084V5	127	New	CPHU213675S4	108
ESU245464	ESU245464V4	114	New	CBU213064V4	126	New	CPHU213675V4	108
ESU245472	ESU245472V4	114	New	CBU213072V4	126	New	CPHU214267S4	108
ESU246064	ESU246064V4	114	New	CBU213084V5	127	New	CPHU214267V4	108
ESU246072	ESU246072V4	114	New	CBU213664V4	126	New	CPHU214275S4	108
New	CBA183064V4	126	New	CBU213684V5	127	New	CPHU214275V4	108
New	CBA183072V4	126	New	CBU214264V4	126	New	CPHU214867S4	108
New	CBA183084V5	127	New	CBU214284V5	127	New	CPHU214867V4	108
New	CBA183664V4	126	New	CBU214864V4	126	New	CPHU214875S4	108
New	CBA183684V5	127	New	CBU214884V5	127	New	CPHU214875V4	108
New	CBA184264V4	126	New	CBU215464V4	126	New	CPHU215467S4	108
New	CBA184284V5	127	New	CBU215484V5	127	New	CPHU215467V4	108
New	CBA184864V4	126	New	CBU216064V4	126	New	CPHU215475S4	108
New	CBA184884V5	127	New	CBU216084V5	127	New	CPHU215475V4	108
New	CBA185464V4	126	New	CBU243064V4	126	New	CPHU216067S4	108
New	CBA185484V5	127	New	CBU243072V4	126	New	CPHU216067V4	108

CAMSHELIVING® CODE CONVERSION LIST

OLD CODE	NEW CODE	PAGE	OLD CODE	NEW CODE	PAGE	OLD CODE	NEW CODE	PAGE
New	CPHU216075S4	108	New	CSMHDTKE6	109	New	EMU245478V4	115
New	CPHU216075V4	108	New	CSSD188	102	New	EMU246070V4	115
New	CPHU243667S4	108	New	CSSD218	102	New	EMU246078V4	115
New	CPHU243667V4	108	New	CSSD248	102	New	ESU182464V4	114
New	CPHU244267S4	108	New	EA182464V4	114	New	ESU182472V4	114
New	CPHU244267V4	108	New	EA182472V4	114	New	ESU182484V5	115
New	CPHU245467S4	108	New	EA182484V5	115	New	ESU183064V4	114
New	CPHU245467V4	108	New	EA183064V4	114	New	ESU183072V4	114
New	CPHU245475S4	108	New	EA183072V4	114	New	ESU183084V5	115
New	CPHU245475V4	108	New	EA183084V5	115	New	ESU183684V5	115
New	CPHU246067S4	108	New	EA183684V5	115	New	ESU184284V5	115
New	CPHU246067V4	108	New	EA184284V5	115	New	ESU184884V5	115
New	CPHU246075S4	108	New	EA184884V5	115	New	ESU185484V5	115
New	CPHU246075V4	108	New	EA185484V5	115	New	ESU186084V5	115
New	CPMU213675DDPKG	105	New	EA186084V5	115	New	ESU187264V4	114
New	CPMU244875PDPKG	105,243	New	EA187264V4	114	New	ESU187272V4	114
New	CPTR24	104	New	EA187272V4	114	New	ESU187284V5	115
New	CPTR30	104	New	EA187284V5	115	New	ESU212464V4	114
New	CPTR36	104	New	EA212464V4	114	New	ESU212472V4	114
New	CPTR362PK	104	New	EA212472V4	114	New	ESU212484V5	115
New	CPTR42	104	New	EA212484V5	115	New	ESU213064V4	114
New	CPTR422PK	104	New	EA213064V4	114	New	ESU213072V4	114
New	CPTR48	104	New	EA213072V4	114	New	ESU213084V5	115
New	CPTR482PK	104	New	EA213084V5	115	New	ESU213684V5	115
New	CPTR54	104	New	EA213684V5	115	New	ESU214284V5	115
New	CPTR542PK	104	New	EA214284V5	115	New	ESU214884V5	115
New	CPTR60	104	New	EA214884V5	115	New	ESU215484V5	115
New	CPTR602PK	104	New	EA215484V5	115	New	ESU216084V5	115
New	CPTR72	104	New	EA216084V5	115	New	ESU217264V4	114
New	CPU182464V4	98	New	EA217264V4	114	New	ESU217272V4	114
New	CPU182472V4	98	New	EA217272V4	114	New	ESU217284V5	115
New	CPU182484V5PKG	99	New	EA217284V5	115	New	ESU242464V4	114
New	CPU183064V4	98	New	EA242464V4	114	New	ESU242472V4	114
New	CPU183072V4	98	New	EA242472V4	114	New	ESU242484V5	115
New	CPU183084V5PKG	99	New	EA242484V5	115	New	ESU243064V4	114
New	CPU183684V5PKG	99	New	EA243064V4	114	New	ESU243072V4	114
New	CPU184284V5PKG	99	New	EA243072V4	114	New	ESU243084V5	115
New	CPU184884V5PKG	99	New	EA243084V5	115	New	ESU243684V5	115
New	CPU185484V5PKG	99	New	EA243684V5	115	New	ESU244284V5	115
New	CPU186084V5PKG	99	New	EA244284V5	115	New	ESU244884V5	115
New	CPU187264V4PKG	98	New	EA244884V5	115	New	ESU245484V5	115
New	CPU187272V4PKG	98	New	EA245484V5	115	New	ESU246084V5	115
New	CPU187284V5PKG	99	New	EA246084V5	115	New	ESU247264V4	114
New	CPU212464V4	98	New	EA247264V4	114	New	ESU247272V4	114
New	CPU212472V4	98	New	EA247272V4	114	New	ESU247284V5	115
New	CPU212484V5PKG	99	New	EA247284V5	115	New	ETR24	120
New	CPU213064V4	98	New	ECC10	117	New	ETR30	120
New	CPU213072V4	98	New	ECC8	117	New	ETR36	120
New	CPU213084V5PKG	99	New	EDS14H12	117	New	ETR362PK	120
New	CPU213684V5PKG	99	New	EDS18H12	117	New	ETR42	120
New	CPU214284V5PKG	99	New	EDS21H12	117	New	ETR422PK	120
New	CPU214884V5PKG	99	New	EDS24H12	117	New	ETR48	120
New	CPU215484V5PKG	99	New	EMTR36	120	New	ETR482PK	120
New	CPU216084V5PKG	99	New	EMTR362PK	120	New	ETR54	120
New	CPU217264V4PKG	98	New	EMTR42	120	New	ETR542PK	120
New	CPU217272V4PKG	98	New	EMTR422PK	120	New	ETR60	120
New	CPU217284V5PKG	99	New	EMTR48	120	New	ETR602PK	120
New	CPU242464V4	98	New	EMTR482PK	120	New	ETR72	120
New	CPU242472V4	98	New	EMTR54	120			
New	CPU242484V5PKG	99	New	EMTR542PK	120			
New	CPU243064V4	98	New	EMTR60	120			
New	CPU243072V4	98	New	EMTR602PK	120			
New	CPU243084V5PKG	99	New	EMU185470V4	115			
New	CPU247264V4PKG	98	New	EMU185478V4	115			
New	CPU247272V4PKG	98	New	EMU186070V4	115			
New	CPU247284V5PKG	99	New	EMU186078V4	115			
New	CSDDC	105	New	EMU215470V4	115			
New	CSDDC5	105	New	EMU215478V4	115			
New	CSDR8	105	New	EMU216070V4	115			
New	CSDR84	105	New	EMU216078V4	115			
New	CSMHDTKE4	109	New	EMU244878PDPKG	243			
New	CSMHDTKE5	109	New	EMU245470V4	115			



Visit the NEW Camshelving Microsite at www.cambro.com/camshelving for product information and pricing on ALL available shelving products. View or download the NEW Camshelving Specification and Price List. Or scan QR code.

STEMWARE AND GLASS SIZING REFERENCE GUIDE

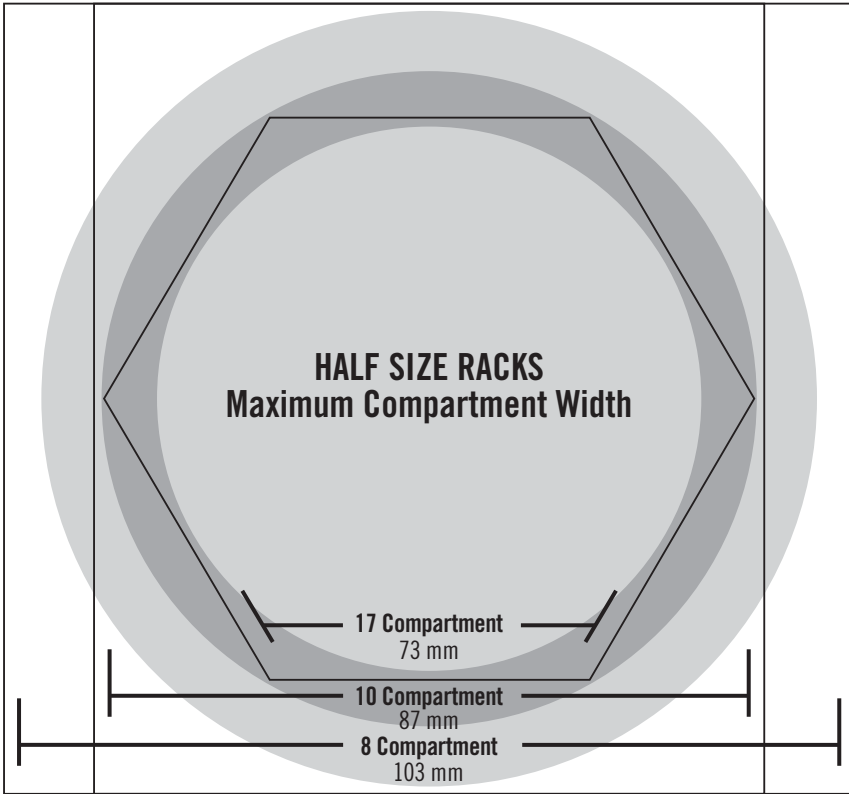

To Determine Compartment Size

- **Half Size Racks:**
Place glass or stemware upside down over circle chart. Look down on the glass. Whatever circle the largest diameter of the glass fits within will determine the number of compartments.
- **Full Size Racks:**
Place glass or stemware upside down over circle chart. Look down on the glass. Whatever circle the largest diameter of the glass fits within will determine the number of compartments.

Use the vertical guide marks at right to determine item height and appropriate rack number.

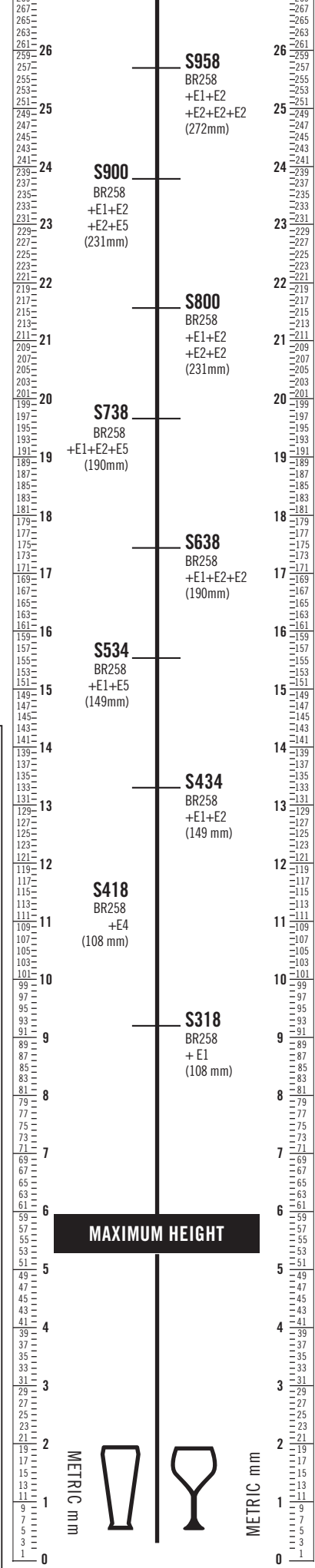
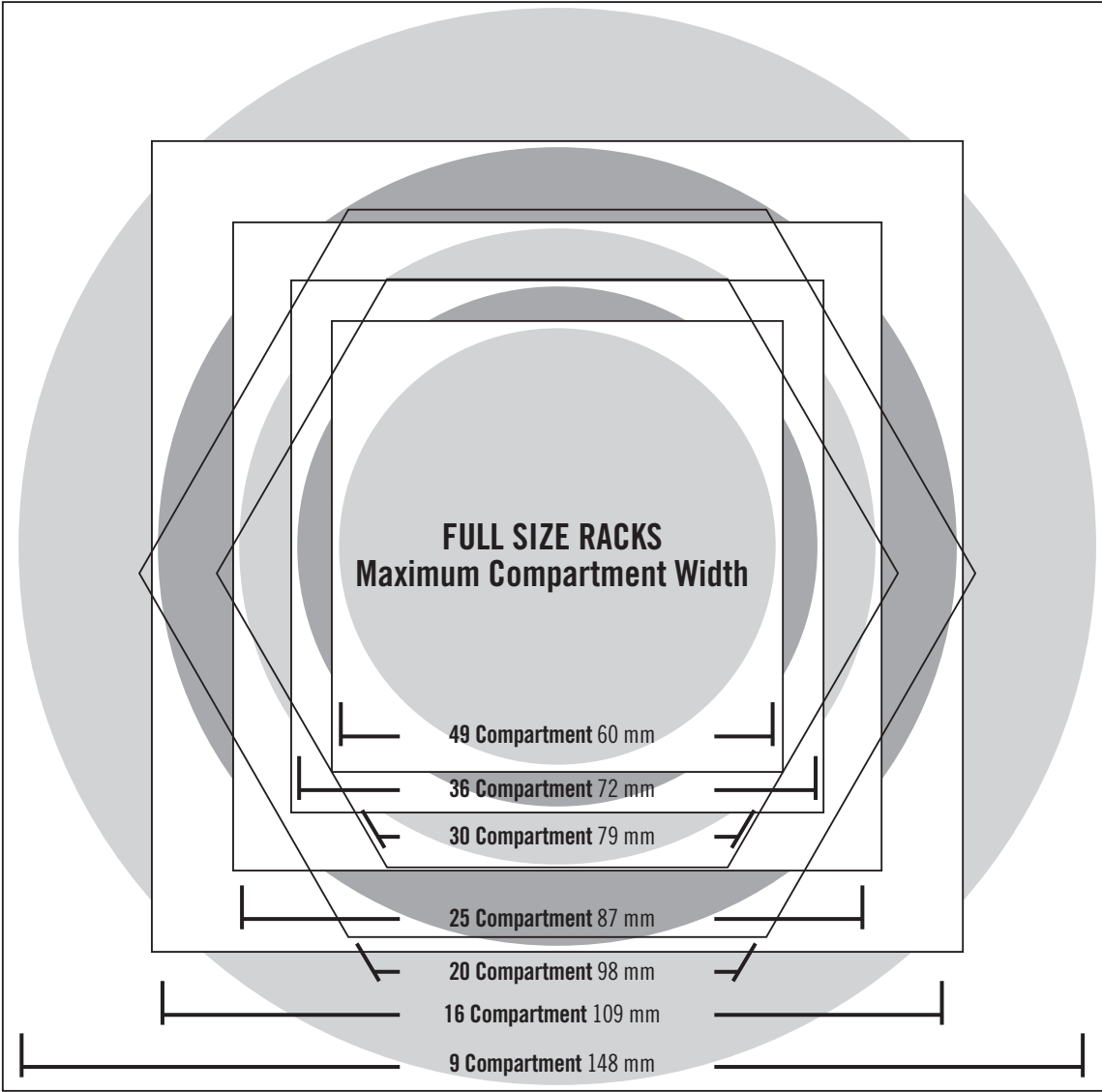
CAMRACK® CUP RACK REFERENCE GUIDE

16

FULL RACK

COMPARTMENT
11,1 x 11,1 cm

QUICK GUIDE

Full Size Cup Racks (C)

Maximum Cup Width	Number of Compartments	Maximum Cup Height		
		6,6 cm	10,7 cm	14,9 cm
11,1 cm	16	16C258	16C414	16C578
8,8 cm	20	20C258	20C414	20C578

To determine Cup compartment size:

Turn cup or coffee mug upside down and place diagonally in square. Align handle with arrow in square. Cup or mug and handle must fit completely within boundaries of a square in order to ensure the right rack.

20

FULL RACK

COMPARTMENT
11,1 x 8 cm

10

HALF RACK

COMPARTMENT
10,4 x 8,8 cm

8

HALF RACK

COMPARTMENT
11,3 x 10,4 cm

QUICK GUIDE

Full Size Cup Racks (C)

Maximum Cup Width	Number of Compartments	Maximum Cup Height	
		6,6 cm	10,7 cm
10,4 cm	8	8HC258	8HC414
8,8 cm	10	10HC258	10C414

To Determine Cup Height:

Place base of cup or coffee mug on flat surface hold ruler vertically next to it to determine height in inches or millimeters. If the height is greater than 108 mm, additional 41 mm E2 and HE2 extenders may be ordered.

CAMBRO® EQUIPMENT COLOR CHART



180
Gray



157
Coffee Beige



158
Hot Red

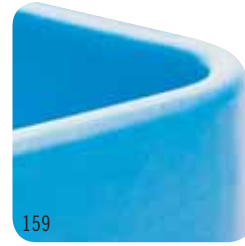

159
Cold Blue



480
Speckled Gray



417
Dark Taupe



402
Brick Red



186
Navy Blue

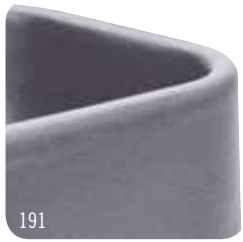

191
Granite Gray



194
Granite Sand

Cambro provides a wide selection of colors to help you coordinate with your decor and color code items to simplify use. Color selections vary by product. Please see individual products for specific colors offered.

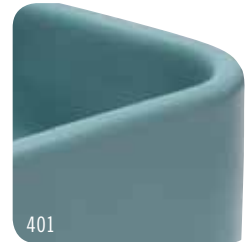

401
Slate Blue

Due to the printing process, the colors shown may not be exact. For exact colors, contact Cambro or a Cambro Sales Representative for a color chip.



615
Charcoal Gray



131
Dark Brown

Due to the catalog printing process, the colors shown may not be exact. For exact colors, contact Cambro or a Cambro representative for a color chip.



192
Granite Green



110
Black



519
Kentucky Green

NEW FROM CAMBRO®



Cam GoBox®
Insulated Carriers
Page 8



Camrack®
Extender ID Clips
Page 71



1/8 Size Polycarbonate and
High Heat Food Pans
Page 149, 153



Camshelving®
Shelf Divider
Page 102, 119, 128

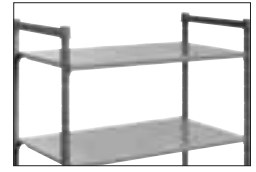

Camshelving Basics Series
Solid Shelf Plates
Page 124, 125



Lido® Tumblers
Page 170



Camtrays® with Handles
Page 213, 250



Angled Drying and Storage
Rack / Cradle
Page 105, 121, 243



Dome Drying and Storage
Rack / Cradle
Page 105, 120, 243



Non-Slip Camtrays with Handles
Page 216, 249



Camwear® Non-Slip Trays
Page 218, 250



CAMBRO U.S.A.
5801 Skylab Road, Huntington Beach, CA 92647
P.O. Box 2000, Huntington Beach, CA 92647-2000
TEL: 1(714) 848-1555 FAX: 1(714) 843-2630
international@cambro.com

© Copyright Cambro Manufacturing Company. Printed in the U.S.A.

CAT2016/17MTWLD



Cambro is a proud recipient of the U.S. President's E-Award for Excellence in Exporting.